

THE LEADING RADIO MAGAZINE

RADIO NEWS

AND

SHORT WAVE RADIO

SHORT
WAVE
TIME
TABLE

November

Special Features:

- **Modern Beam Antennas**
- **Black Light Burglar Alarm**
- **Mobile P. A.**
- **Service Helps**
- **Amateur Transmitters**
- **Simple Neon Oscillator**
- **Home Set Construction**

25c

U. S. and
Canada

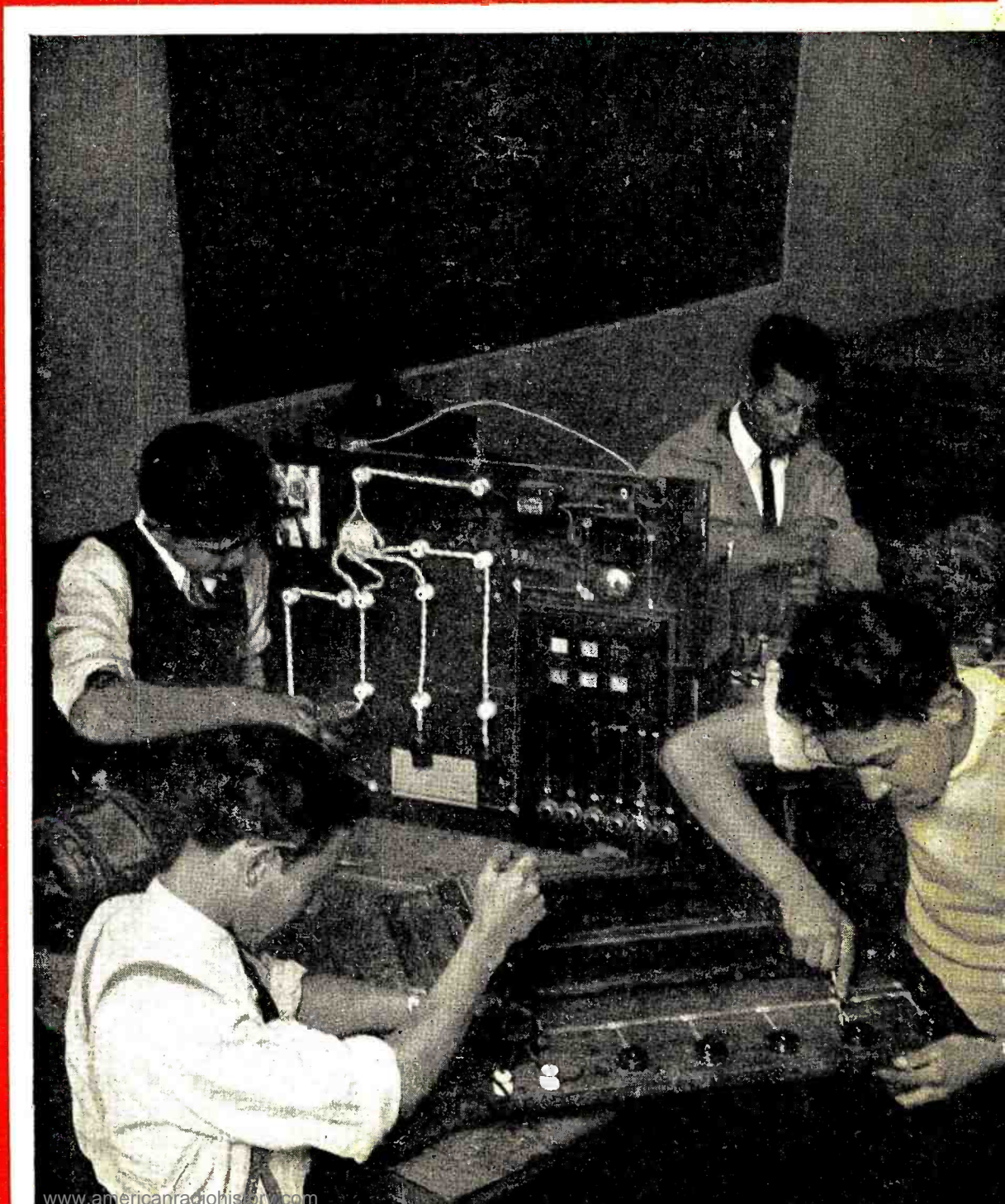

25,000 OHMS PER VOLT

TRIPLET
DELUXE SET TESTER

Entirely New

**Modern Design
for Quick,
Accurate Set
Testing!**



Model 1601
\$45.33
In Metal Case

- D.C. Volts at 25,000 Ohms per Volt. A.C. Volts at 1,000 Ohms per Volt. Reads to 2,000 Volts A.C. and D.C. in 6 Ranges.
- Resistance Measurements to 20 Meg-ohms.
- Condenser Tester to 30 Mfds.
- Free Point Tester.
- Incorporates Exclusive Plug-in Type Copper Oxide Rectifier.
- New Single Zero Adjustment for Ohm-meter.
- All A.C. Operated—No Batteries Used.
- 250 Microamperes to 20 Amperes in 8 Ranges.

Triplet's new DeLuxe Set Tester incorporates the very latest features in set testing. Ultra high class and professional appearance. Durable etched panel having natural silver background with sunken black lettering. Control knobs and other fittings are finished in red. The exclusive plug-in type copper oxide rectifier is the approved,

most accurate method for rectification, with the newly added advantage of easy replacement due to accidental damage or overloading. Replaces as easily as removing an ordinary fuse. In leatherette case, as shown, \$49.33.

**TRIPLET'S NEW
DELUXE LINE OF
RADIO TESTERS**

**SETS A
"NEW HIGH"**

**IN ACCURACY
APPEARANCE
AND PRACTICABILITY**

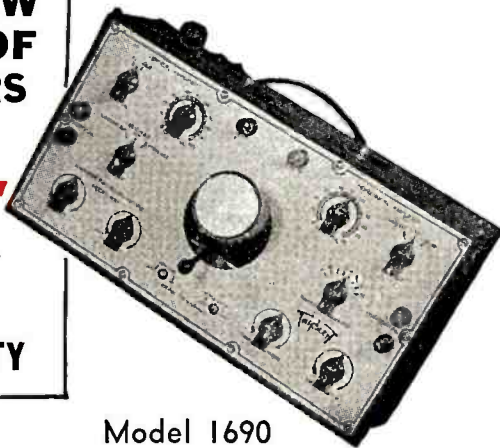

Model 1690

Other De Luxe Items:

- Model 1690 Oscilloscope.** . . . With 2" screen . . . exclusive Triplet turret type mounting. Linear Sweep 15 to 20,000 Cycles complete with tubes and instructions. . . . In Metal Case. . . . **\$47.00**
- Model 1630.** . . . Outstanding Signal Generator for extreme accuracy . . . zero leakage . . . 100 K.C. to 30 M.C. in six ranges complete. . . . In Metal Case. . . . **\$45.00**
- Model 1631.** . . . Same as 1630 but in addition incorporates electronic frequency modulation. . . . In Metal Case. . . . **\$55.00**
- Model 1670.** . . . Vibrator Tester . . . completely tests all vibrators under actual performance conditions. . . . In Metal Case. . . . **\$24.00**

All DeLuxe Testers in two case styles: Sturdy metal with black wrinkle finish, 14½" x 7¾" x 4½". Leatherette covered case has removable cover and compartment for accessories, size 15½" x 12" x 6¾".

TRIPLET
Precision
ELECTRICAL INSTRUMENTS

THE TRIPLET ELECTRICAL INSTRUMENT CO.
1511 Harmon Ave., Bluffton, Ohio

Please send me more information on:
 Model 1601; Model 1690; Model 1630;
 Model 1631; Model 1670. I am also inter-

ested in
 Name
 Address
 City State

**A FREE LESSON
SHOWED BILL HOW HE COULD
MAKE GOOD PAY
IN RADIO**

BILL, YOU'RE ALWAYS FOOLING WITH RADIO -- OUR SET WON'T WORK -- WILL YOU FIX IT?

I'LL TRY, MARY, I'LL TAKE IT HOME TONIGHT



I CAN'T FIND OUT WHAT'S WRONG -- GUESS I'LL MAKE A FOOL OF MYSELF WITH MARY

HELLO, BILL -- GOT A TOUGH ONE TO FIX? LET ME HELP YOU

HELLO JOE -- WHERE'VE YOU BEEN LATELY -- AND WHERE DID YOU LEARN ANYTHING ABOUT RADIO?

I'VE BEEN STUDYING RADIO AT HOME, BILL, WITH THE NATIONAL RADIO INSTITUTE. YOU OUGHT TO TAKE THEIR COURSE. I'VE GOT A GOOD RADIO JOB NOW. LET'S MAKE A CIRCUIT DISTURBANCE TEST -- STARTING WITH THE AUDIO OUTPUT STAGE AND TESTING EVERY STAGE RIGHT BACK TO THE ANTENNA. LISTEN FOR THE CLICKS WHEN I TAP THE GRID LEADS

SAY -- WHERE DID YOU LEARN THAT TEST? IT'S A GOOD ONE

HERE'S THE TROUBLE, BILL, IN THE FIRST I.F. AMPLIFICATION STAGE. I LEARNED THAT TEST EVEN BEFORE I STARTED TAKING THE COURSE, BILL. IT'S DESCRIBED IN A FREE LESSON WHICH THE NATIONAL RADIO INSTITUTE SENDS YOU WHEN YOU MAIL A COUPON FROM ONE OF THEIR ADS

I'VE SEEN THEIR ADS BUT I NEVER THOUGHT I COULD LEARN RADIO AT HOME -- I'LL MAIL THEIR COUPON RIGHT AWAY

I'M CONVINCED NOW THAT THIS COURSE IS PRACTICAL AND COMPLETE. I'LL ENROLL NOW

AND THEN I CAN MAKE REAL MONEY SERVICING RADIO SETS

OR INSTALL AND SERVICE LOUD SPEAKER SYSTEMS

OR GET A JOB WITH A RADIO BROADCASTING OR TRANSMITTING STATION

AVIATION RADIO, POLICE RADIO, TELEVISION, ELECTRONIC CONTROLS -- RADIO IS SURELY GOING PLACES. AND THE NATIONAL RADIO INSTITUTE HAS TRAINED HUNDREDS OF MEN FOR JOBS IN RADIO

**I will send you a Lesson on
Radio Servicing Tips FREE
TO SHOW HOW PRACTICAL IT IS
TO TRAIN AT HOME FOR
GOOD JOBS IN RADIO**

Do you want to make more money? I'm sure I can train you at home in your spare time for a good Radio Job. I'll send you a sample lesson FREE. Examine it, read it, see for yourself how easy it is to understand even if you've never had technical experience or training.

Many Radio Experts Make \$30, \$50, \$75 a Week

Radio broadcasting stations employ engineers, operators, station managers and pay up to \$5,000 a year. Spare time Radio set servicing pays as much as \$200 to \$300 a year. Full time Radio servicing jobs pay as much as \$30, \$50, \$75 a week. Many Radio Experts operate their own full time or part time Radio sales and service businesses. Radio manufacturers and jobbers employ testers, inspectors, foremen, engineers, servicemen, paying up to \$6,000 a year. Radio operators on ships get good pay. see the world besides. Automobile, police, aviation, commercial Radio, and loud speaker systems offer good opportunities now and for the future. Television promises many good jobs soon. Men I trained have good jobs in these branches of Radio.

Many Make \$5, \$10, \$15 a Week Extra in Spare Time While Learning

Almost every neighborhood needs a good spare time serviceman. The day you enroll I start sending you Extra Money Job Sheets. They show you how to do Radio repair jobs, how to cash in quickly. Throughout your training I send you plans and ideas that have made good spare time money—from \$200 to \$500 a year—for hundreds of fellows. I send you special Radio equipment, show you how to conduct experiments, build circuits illustrating important Radio

principles. My training gives you practical Radio experience while learning.

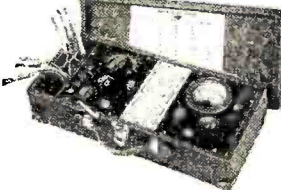

I Give You This Professional Servicing Instrument

Here is the instrument every Radio expert needs and wants—an All-Wave, All-Purpose, Set Servicing Instrument. It contains everything necessary to measure A.C. and D.C. voltages and current; test tubes, resistance; adjust and align any set, old or new. It satisfies your needs for professional servicing after you graduate—can help you make extra money servicing sets while training.

Get My Lesson and 64-Page Book FREE—Mail Coupon

In addition to my Sample Lesson, I will send you my 64-page Book, "Rich Rewards in Radio." Both are free to any fellow over 16 years old. My book points out Radio's spare time and full time opportunities and those coming in Television; tells about my training in Radio and Television; shows my Money Back Agreement; shows you letters from men I trained, telling what they are doing, earning. Find out what Radio offers YOU! MAIL THE COUPON in an envelope, or paste it on a penny postcard—NOW!

J. E. Smith, Pres., National Radio Institute Dept. 7MR Washington, D. C.



J. E. SMITH
President
National Radio Institute
Established 1914
The man who has directed the home study training of more men for the Radio Industry than any other man in America.



YOU CERTAINLY KNOW RADIO. SOUNDS AS GOOD AS THE DAY I BOUGHT IT.

THANKS! IT CERTAINLY IS EASY TO LEARN RADIO THE N.R.I. WAY. I STARTED ONLY A FEW MONTHS AGO, AND I'M ALREADY MAKING GOOD MONEY.



THIS SPARE TIME WORK IS GREAT FUN AND PRETTY SOON I'LL BE READY FOR A FULL TIME JOB

OH BILL -- I'M SO GLAD I ASKED YOU TO FIX OUR RADIO. IT GOT YOU STARTED THINKING ABOUT RADIO AS A CAREER, AND NOW YOU'RE GOING AHEAD SO FAST

OUR WORRIES ARE OVER. I'M MAKING GOOD MONEY NOW, AND THERE'S A BIG FUTURE AHEAD FOR US IN RADIO



J. E. SMITH, President, Dept. 7MR National Radio Institute, Washington, D. C.

Dear Mr. Smith: Without obligation, send me a sample lesson and your free book about the spare time and full time Radio opportunities, and how I can train for them at home in spare time—about the N.R.I. Set Servicing Instrument you give me. (Please write plainly.)

Name Age

Address

City State

14X-1



Edited by LAURENCE MARSHAM COCKADAY

S. GORDON TAYLOR
Managing Editor

WILLIAM C. DORF
Associate Editor

JOHN M. BORST
Technical Editor

JOHN H. POTTS
Assoc. Tech. Editor

"BILL" EVERETT
Art Editor

Vol. XIX, November, 1937

No. 5

Reading Guide to this Issue—

AMATEURS—1, 3, 4, 5, 8, 10, 14, 15, 16, 17, 18, 19, 23, 26, 27, 29
BROADCAST FANS—1, 4, 13, 15, 16, 20, 23, 29
DEALERS—1, 4, 6, 8, 9, 11, 22
DESIGNERS—1, 4, 6, 11, 26, 29
DX FANS—1, 3, 4, 8, 13, 15, 16, 20, 23, 28, 29
ENGINEERS—1, 4, 5, 6, 26, 29
EXPERIMENTERS—1, 3, 4, 6, 7, 8, 10, 26, 29
MANUFACTURERS—1, 4, 6
OPERATORS—1, 3, 4, 5, 25, 26, 29
SERVICEMEN—1, 2, 3, 4, 6, 9, 10, 11, 12, 13, 15, 16, 20, 23, 26, 29
SET BUILDERS—1, 3, 4, 6, 8, 10, 11, 26, 29
SHORT-WAVE FANS—1, 3, 4, 8, 13, 15, 16, 20, 21, 22, 23, 27, 29
STUDENTS—1, 2, 3, 4, 5, 6, 7, 8, 9, 10, 11, 12, 13, 15, 16, 18, 20, 23, 24, 26, 29
TECHNICIANS—1, 2, 3, 4, 6, 10, 11, 12, 26, 29

Do You Know—

THAT RADIO NEWS maintains a well-equipped and well-staffed Laboratory as well as several Listening Posts in and around New York City?

THAT constructional articles appear in RADIO NEWS only after thorough testing of the models in this Laboratory or the official Listening Posts, or both?

THAT no manufactured receiver or commercial apparatus of any kind is described in the feature articles in RADIO NEWS until it has been similarly tested and approved?

THIS is done so that you, as a reader of RADIO NEWS, may have full confidence in all equipment which you find described in RADIO NEWS.

1	Radio Facts and Oddities.....	H. T. Elmo	259
2	Serviceman's Diary	Anonymous	260
3	ABC's of Antenna Design (Part 1).....	I. Queen	263
4	What's New In Radio.....	The Associate Editor	265
5	U.H.F. Beam Antennas.....	Laurence M. Cockaday	266
6	A Black-Light Burglar Alarm.....	Guy Forest	268
7	The Radio Voter.....	Samuel Kaufman	269
8	The Communication "14" (Part 1).....	Clifford E. Denton	270
9	The Service Bench.....	Zeh Bouck	272
10	Neon-Tube Audio Oscillator.....	Emil Buchwald	274
11	Mobile P. A. Considerations.....	Harry Paro	275
12	Servicing Movie Sound (Part 4).....	W. W. Waltz	276
13	New Midwest Push-Button Tuning.....	William C. Dorf	277
14	The "Ham" Shack.....	Everett M. Walker	278
15	A New Super with a Novel Dial.....	Robert Ames	279
16	The "Skyrider" 11-Tube Receiver.....	Cockaday and Taylor	280
17	Testing a 10-160 Transmitter (Part 2).....	By W2MW	281
18	Installing the "Tiny Tot" Mobile Rig.....	S. Gordon Taylor	282
19	1-Kw. Transmitter for 10 and 20 Meters (Conclusion).....		284
20	"Masterpiece" 21-Tube Receiver (Part 2).....	McMurdo Silver	285
21	The DX Corner for Short Waves.....	The Editor	286
22	World Short-Wave Time-Table.....		288
23	The "Super-Pro" for the Home.....	Gordon Fraser	290
24	Students' Radio Physics Course.....	Alfred A. Ghirardi	294
25	Q R D ?	By G Y	296
26	The Technical Review.....	John M. Borst	298
27	The Amateur Observer.....	By W2JCR	300
28	The DX Corner for the Broadcast Band.....		302
29	Free Booklet Service.....		319

Published Monthly by Teck Publications, Inc., Washington and South Avenues, Dunellen, N. J.

Lee Ellmaker
President and Treas.
B. Holcepl
Secretary
Walter C. Freeman
Eastern Advertising Manager
Virgil Malcher
Western Advertising Manager
605 N. Michigan Ave., Chicago
Tel. Superior 8938

EDITORIAL AND EXECUTIVE OFFICES
461 EIGHTH AVENUE, NEW YORK CITY, N. Y.

Entered as second class matter at the Post Office at Dunellen, N. J., under the act of March 3, 1879. Copyright, 1937, by Teck Publications, Inc., in U. S. and Canada. All rights reserved. Registration of title of this publication as a trade mark applied for in the United States Patent Office. Printed in the United States of America. The contents of this magazine must not be reproduced without permission. We cannot be responsible for lost manuscripts, although every care is taken for their safety.

25c a copy. Subscriptions, \$2.50 a year, \$4.00 for two years; in Canada and Foreign Countries \$3.00 a year, \$5.00 for two years. Subscribers are notified that change of address must reach us five weeks in advance of the next date of issue.

RADIO FACTS and ODDITIES

(Send in your Radio Oddities to "Elmo" and see them illustrated)

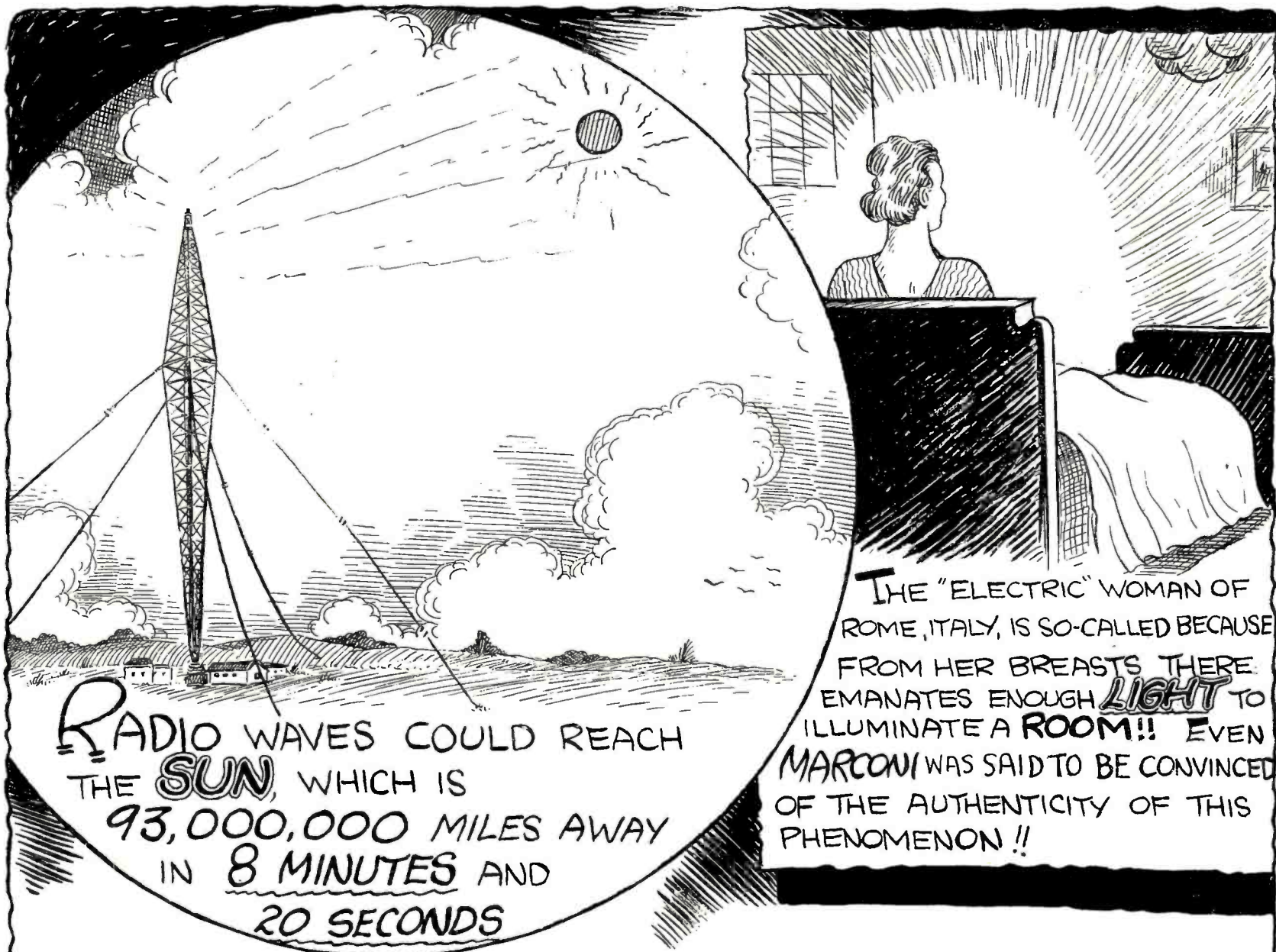

RADIO WAVES COULD REACH THE **SUN**, WHICH IS 93,000,000 MILES AWAY IN 8 MINUTES AND 20 SECONDS

THE "ELECTRIC" WOMAN OF ROME, ITALY, IS SO-CALLED BECAUSE FROM HER BREASTS THERE EMANATES ENOUGH **LIGHT** TO ILLUMINATE A ROOM!! EVEN **MARCONI** WAS SAID TO BE CONVINCED OF THE AUTHENTICITY OF THIS PHENOMENON!!



THE U.S. NAVY ARLINGTON STATION KNOWN AS NAA, HAS BROADCAST DAY IN AND DAY OUT, SINCE IT FIRST WENT ON THE AIR, BACK IN 1912!!!

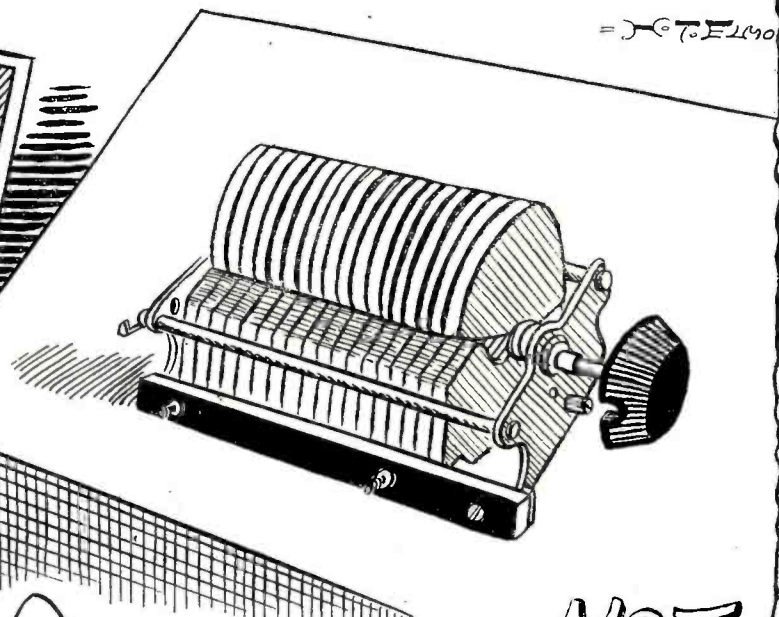

A CONDENSER DOES **NOT** CONDENSE!! IT MERELY STORES ELECTRICITY!! THE ACCEPTED NAME FOR IT IS A "CAPACITOR".....

Pages From A Serviceman's DIARY

THURSDAY. Regarding the opportunity abroad which we wrote about a few months ago, a very large number of letters, telegrams and personal calls have been received. Many have been put in touch with our foreign correspondent and when we find out who has been selected we shall be glad to let you know. The grass always looks greener on the other side. We had one applicant, a 28-year-old Californian, who in 12 years of servicing had accumulated *fifteen thousand dollars*. In his spare time, he also acquired one electrical engineering diploma, one transmitter with push-pull 860 finals, 850 watts input at 3500 volts, and one wife. All these in a state which contains more servicemen per-square-inch than any other section of the world. Boy, has he got something! How he did it, I'd like to know. Yet he wants to go abroad.

Even around here some have done well under severe handicaps.

Three "Other" Fellows

For instance, during the worst of the depression three young fellows in our neighborhood lost their jobs. Their technical knowledge and experience were too limited to qualify them for good service work so they had been assigned to delivery and installation jobs. When the public demand shifted to low-priced midget radios requiring no outside aerials, their employers found there was not enough installation work to keep the boys busy. Since repair work also decreased full-fledged servicemen were obliged to take over the installation work as well. Inevitably, hurried make-shift jobs resulted.

Surveying Rooftops

These three musketeers surveyed the roof-tops and saw their opportunity. They resurrected a wise but unenforced fire ordinance which specified that all antennas must be erected so as to clear the roof by at least ten feet. Obviously, a broken aerial wire or even one which sagged down below the ten-foot limit constituted a violation of the law. Armed with copies of this ordinance, they punched door-bells wherever they saw a defective aerial installation, pointing out to alarmed housewives that the aerials should be repaired, not only to assure better reception but also to comply with the law. Then they offered to make a ship-shape installation at a nominal fee. Needless to say, they got plenty of work. Working rapidly and systematically, they made excellent installations in a relatively short time. They used no window lead-in strips. A hole was drilled through the wall, sloping downward so that no rain could seep through, and a porcelain bushing is fitted in this hole. All insurance and Board of Fire Underwriters' specifications were complied with. Lightning arrestors were included in all their jobs and they were careful to point out to customers that tacking down power-line cords with saddle staples constitutes a violation and fire hazard. Such attention to detail has made them specialists in this line.

With the increased public interest in good

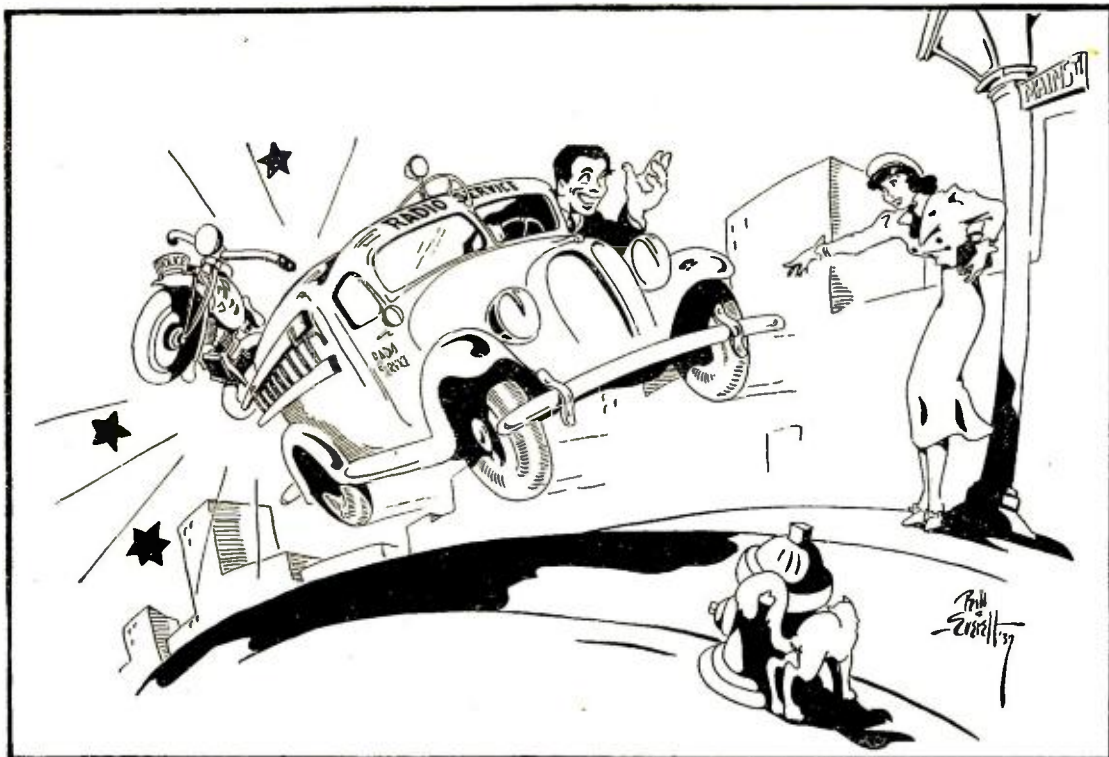

IT'S THE DETAILS OF SERVICE WORK THAT REALLY COUNT

Being careful about small items not only in repairing sets but in watching costs is the way to run a successful service business. At least, someone in the organization should do it and usually the task rests upon the "pilot." Often, some occasion captures our full attention and other details, quite as important, escape our notice until the "crash" comes. Servicemen should learn a lesson from this cartoon and always go forward instead of backward.

aerial jobs so necessary for all-wave receivers, they have prospered. Dealers have found it to their advantage to turn over their higher-priced installations to these young fellows. As a result, their work schedule is usually filled up for days ahead. Today is one of those days. Jerry slapped a delivery slip on the test bench.

A Little Argument

"This Radiola has got to be delivered and installed this morning. Aerial service is booked up solid so you're elected. Take along a Magic Wave antenna and see that it is put up so it stays put," Jerry said. (In other words, a permanent wave. What do they think I am, a beautician?)

"How about some help?" I asked. "That set's heavy and I'll need ladders to put up the aerial."

"I'll give you a hand," he offered, none too cordially. "But don't expect me to do all the work. The last time we went out together you said you would do all the inside work while I did the outside job, putting up the aerial. When I came in, I found there hadn't been any inside work to do. You spent all your time trying to date up the maid." (That wasn't true. I had to change the ground clamp too.)

Getting Started

We hoisted the set into the truck, then tied the long, extension ladders alongside. The ends protruded far beyond the back

THESE records from an anonymous serviceman's diary should be of decided interest to veteran servicemen, as well as to those whose experience in the service field is more limited. Written by a man who "knows his stuff," and shot with an occasional outcropping of humor, these items provide many hints not found in text books. More of these pages will appear from time to time:

of the truck, a make-shift arrangement. We checked over the tools and equipment, then hopped in the car.

The car faced up-hill. The battery was none too strong, so I have been starting the car by letting it coast and then throwing in the clutch. As it glided backward, I noticed a young woman waving to me from across the street. I was sure I hadn't seen her before but I couldn't let her down. I tried to tip my hat but remembered too late that I wasn't wearing one. Suddenly there was a crash and a sound of breaking glass. I hopped out of the truck and found I had backed into a cop's motorcycle, parked at the curb, knocking it down and breaking the headlight. The woman had been trying to warn me.

Reporting the Accident

Went to the station house a few doors away and reported the accident. I expected a good bawling-out and got it. Since we were both insured, though, there were no other consequences.

We delivered the set at a home on the outskirts of the town. The place was surrounded by tall trees and the owner was dressed in overalls, pruning the boughs of one of the trees. He came over to us and pointed out the tree where he wanted one end of the antenna to be connected.

"Don't do like the last fellows who put up an aerial here," he said. "They wrapped a wire around the trunk. Most of you city fellows don't know that you can kill a tree that way."

I assured him that we always used strong hook-eyes on such jobs and showed him the springs which we connect at each end of the aerial to keep the wire taut as well as to allow for the strain resulting from any swaying of the tree during a strong wind. Of course, we don't attempt to make the connection to young, slender trees.

Open Field Coil

Finished the job before lunch and brought in for repair a Bosch midget. Checked it over and found the field-coil open. (Continued on next page)

Replaced the coil and then peeled off the paper covering over the old coil to try and locate the break. Often it will be near the outer layer so that removing a few yards of wire and replacing the leads will give us a perfectly good replacement for another set with a similar trouble. No such luck this time, though. The inner lead broke off in removing the covering so the whole coil will have to be rewound.

Radio Course at NYU

New York, N. Y.—Laurence M. Cockaday, radio pioneer and Editor of RADIO NEWS, will conduct a course in amateur radio practice and procedure at New York University, Division of General Education. The course has been designed to provide the amateur with the fundamental background necessary for improved understanding of and better results with his equipment. Such problems as the design of transmitters, receivers, antennas, impedance matching, station layout, will be carefully considered. The newest systems used in aviation, ultra-high-frequency beam system, radio beacons, and portable sets will be discussed in fifteen evening sessions beginning Wednesday, September 29.

A course in television will be given by Prof. H. H. Sheldon, director of science courses and former science editor of the "New York Herald Tribune." Television equipment, history, advances and probable future developments will be considered in fifteen evening sessions beginning Tuesday, September 28. Both courses are open to men and women without formal entrance requirements.

The New RK47 Tube

New York, N. Y.—A new transmitting tube for amateurs, type RK47, has been announced by Raytheon. It is a beam type tetrode with aligned grids, a molybdenum plate and an isolantite base. In appearance it is similar to the RK20. The aligned grids help keep the screen current low as compared to the plate current. In this beam-type tube, the deflector plates have been brought out to a pin, and should be connected to the mid-tap of the filament.

Characteristics

The filament requires 10 volts at 3.25 amperes. The interelectrode capacities are: 0.12 mmfd between grid-plate, 13 mmfd input capacity and 10 mmfd output capacity. When used as a Class C r.f. amplifier or oscillator the maximum plate voltage is 1250 volts for telegraphy and 900 volts for telephony. The recommended screen potentials are then 300 and 250 volts respectively. In the c.w. application the grid bias is then—70 volts, plate current 138 ma, screen current 14 ma, the r.f. input power 1 watt and carrier output 120 watts. As a modulated Class C amplifier (telephony) the grid bias should be—120 volts, plate current 90 ma, screen current 23 ma, the r.f. input power 1.1 watts, and the carrier power output 50 watts. The maximum plate dissipation is 50 watts, maximum screen dissipation 10 watts.

The tube can also be employed as a Class B "linear" amplifier with a 1250 volt power supply, the carrier output is then 25 watts and the r.f. input 4 watts. It is not recommended to use the tube for frequencies higher than 60 megacycles and at 60 mc. the plate voltage should not exceed 900 volts.

The Ham Bands

Washington, D. C.—At the request of the ARRL the F. C. C. has amended rule 376 so as to permit type A-3 emission (phone to you) on the frequencies 28,500-30,000 kc. inclusive. Rule 376 now allocates the following bands for amateur stations using telephony: 1800-2000 kc., 28,500-30,000 kc., 56,000-60,000 kc., 400,000-401,000 kc. This order is effective on September 17, 1937.



Metallized

CONTROLS
Now Available in
SPECIAL REPLACEMENT TYPES

WITH THE FIRST AND ONLY . . .
SILENT SPIRAL CONNECTOR
(Designated in Guide with Prefix "J" — Patent Applied For)

"Because It's Positive—It's Positively Noiseless!"

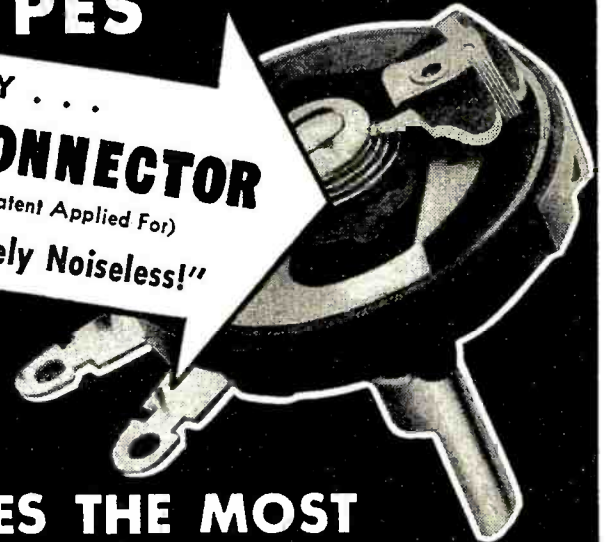

IT ELIMINATES THE MOST COMMON SOURCE OF NOISE IN Any CONTROL

The outcome of two years of engineering development work, IRC brings you the outstanding control improvement in years—positive and continuous electrical connection between the center terminal and adjustment arm. This new Silent Spiral Connector spells complete elimination of sliding, metal-to-metal contact in the place where most control noises originate. This, together with the exclusive "Knee Action" 5-finger Element Contact, is double assurance that these new IRC Special Replacement Controls are exceptionally quiet and permanently so. . . . The Silent Spiral Connector comes on all

IRC Special Replacement Controls listing at \$1.50 and up (not standard types). These special units are specifically designed for those extremely critical replacement jobs that cannot be handled with standard types. They are identified by the letter "J" preceding their part number in the IRC Guide.

- NO NOISE**
- NO SLIDE**
- NO FRICTION**



GET THIS NEW GUIDE FREE!

Just off the press! 208 pages! Lists standard and special replacement types for practically every radio receiver made. Includes handy control and resistance calculation data, complete IRC Resistor Catalog, etc. Ask your jobber for a copy, or write direct to us.

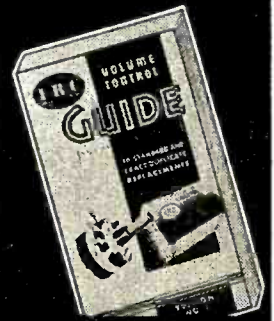

INTERNATIONAL RESISTANCE COMPANY

401 NORTH BROAD STREET, PHILADELPHIA, PA.

Factories or Licensees in Canada, England, France, Germany, Italy, Denmark and Australia

MAKERS OF RESISTANCE UNITS OF MORE TYPES, IN MORE SHAPES, FOR MORE APPLICATIONS THAN ANY OTHER MANUFACTURER IN THE WORLD



Says

MALLORY-YAXLEY
Radio Service Encyclopedia
increased his business

33 1/3 %

IF YOU want to know how much the Mallory-Yaxley Radio Service Encyclopedia can help you in *your* business take a tip from V. P. Kuszenski who writes: "The book which I purchased has *increased my business about 33 1/3 %!* I would not be without it, because it really has helped me to solve my problems in the radio field."

If you want further proof of the value of this single volume . . . which completely covers Schematics-Circuits, Volume Controls, I.F. Peak Frequencies, Transformer Circuits, Condensers, Tubes and Vibrators . . . Charles W. Sult of Wytheville, Va., has this to say: "I received my copy of the Mallory-Yaxley Radio Service Encyclopedia and it paid for itself on one job alone by telling what the I.F. is without sweating and cussing looking for something that is not available. Also the volume control and transformer circuits assure one that the replacement part is properly connected in the circuit. The condenser and vibrator dope is especially valuable to men who service auto radios, and home radios that are similarly designed."

Again, referring to the Mallory-Yaxley Radio Service Encyclopedia, Orrie Winebrumer, of Auburn, Ind., writes: "It's got any book on the market beat that I have ever seen or bought and I know your encyclopedia is *worth more than all the rest of the books I have.*"

How soon are you going to cash in on the greatest help a serviceman ever had? When are you going to get *your* copy of the Mallory-Yaxley Radio Service Encyclopedia? You'll have to work fast! You'd better act *now*—for there are only a few copies left. Don't fail to get *yours!* See your Mallory-Yaxley distributor *right away.*



Use P. R. MALLORY & CO. Inc. MALLORY REPLACEMENT CONDENSERS...VIBRATORS	P. R. MALLORY & CO., Inc. INDIANAPOLIS INDIANA Cable Address—PELMALLO	Use YAXLEY REPLACEMENT VOLUME CONTROLS
---	--	--

Radio News

November, 1937

The A, B, C's of **ANTENNA DESIGN**

(Part One—How Antennas Operate)

Most discussions of the theory of antennas, feeders and impedance-matching devices are so complicated that even trained engineers find them difficult at times. This present series will therefore be most welcome to the average short-wave listener, experimenter, serviceman or "Ham"

ANTENNAS and a working knowledge of antennas are two of the most important factors with which a radioman, no matter who he is, has to deal. But, unfortunately, antennas and how they operate are often more or less mysteries. To explain the phenomena of antenna construction and operation in simple language and in practical rather than mathematical terms, so that all readers will have a clear, basic understanding, is the problem of this series. To the Radio Beginner, as well as to the semi-technical Fan, this first article should be especially interesting and enlightening, for we intend to start out with the basic theory of the antenna itself.

Electron Theory

First of all, let us see what is meant by "standing waves" on an antenna. Let us examine Figure 1. Here we have illustrated an antenna wire high in the air, away from other objects, and well insulated at both ends. Electricity can travel along this wire, but cannot pass through the insulators. According to the electron theory, this current flow is simply the movement of a large number of electrons. Suppose, now, that by some suitable means, we cause the left-hand end of the antenna wire to become negative (with respect to the other end). This means we have accumulated electrons at the former end and a deficiency exists at the latter end, since electrons carry a definite negative charge. The

By I. Queen

right-hand end is therefore positive.

Since each electron repels every other electron, a pressure will exist at the left-hand end and they will all be attracted towards the positive end. This impulse or tendency to move is transmitted from one end of the wire to the other at something less than the speed of light (although the individual electrons themselves acquire only a comparatively slow speed). The speed of this impulse or "electric wave" is what we are interested in.

In a fraction of a second, then, after the start of this wave, the other end of the wire receives this same impulse, and the electrons which are contained in the right-hand end of the wire are now forced in the same direction (to the right). They can pass no further, however, so they merely accumulate here, until their pressure or voltage reaches a maximum at this point. Another wave will now take place in the *opposite* direction. The same result will again take place so that the wave oscillates back and forth at a certain number of times per second, or frequency.

Resonance

This energy will become dissipated in time unless we provide means of supplying additional power to the antenna to make up for losses. Point "A," for instance, will become a high potential point at certain intervals, as we have seen, but due to losses the maximum voltage at this point will decrease progres-

YES, ANTENNAS ARE IMPORTANT!

From the complicated arrays evident in this scene anyone can easily see the importance of knowing something about antenna design and practice. Illustration shows the ultra-high-frequency laboratories and station of W4EDD, H. H. Robinson of Coral Gables, Miami, Florida.

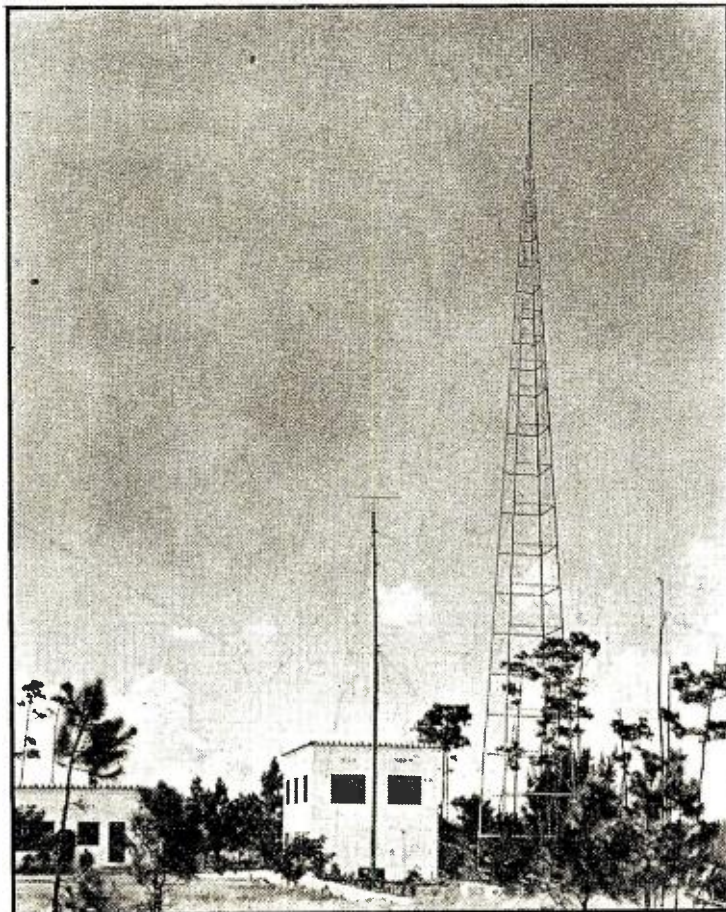

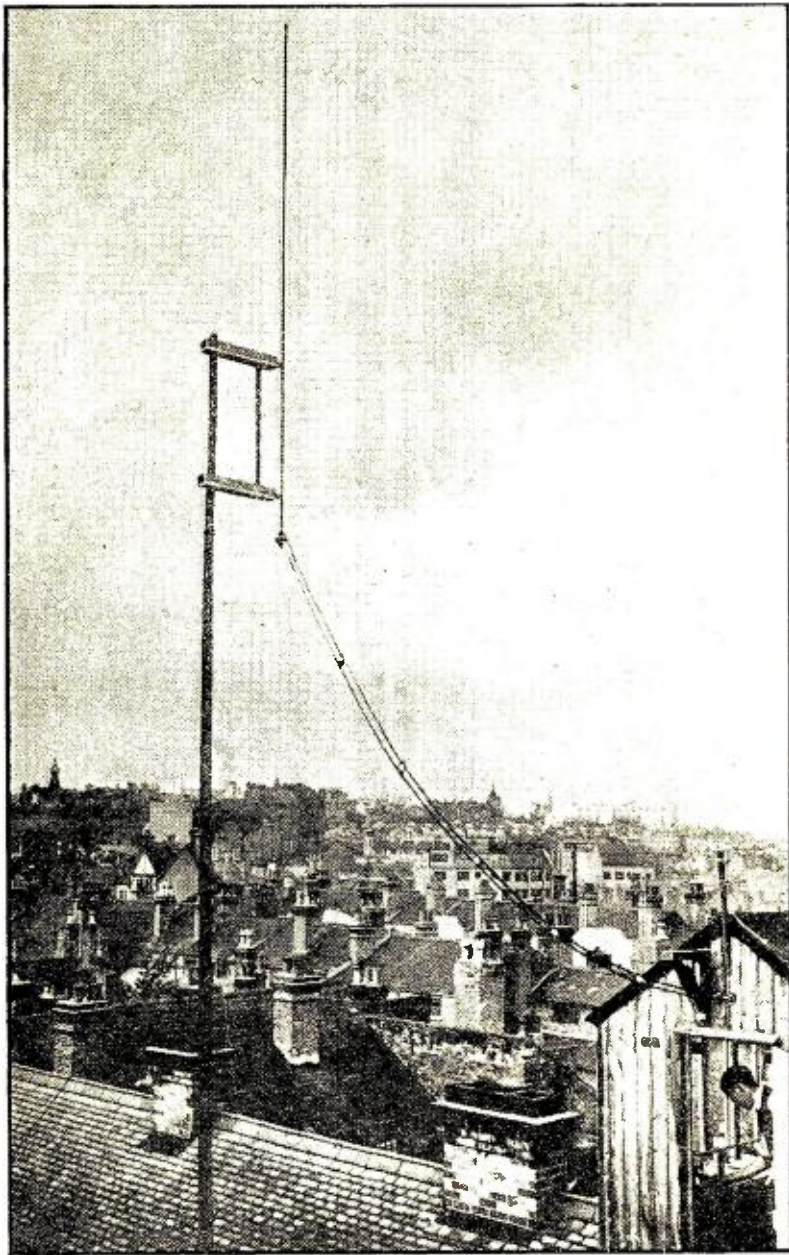

A HALF-WAVE ANTENNA
High on its pole, far above the roof-tops, perches this half-wave Hertz antenna, with its spaced feeders leading down to the radio "shack."

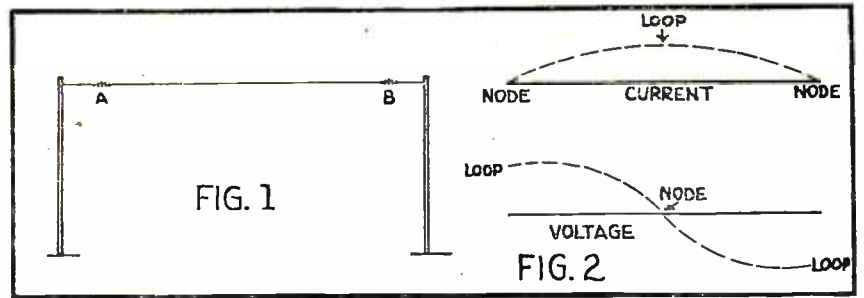

sively unless we make up the difference. This additional power must be supplied IN PHASE, that is, it must be timed (or "in step") with the original power. In this way, we will have one large wave at a time instead of several smaller ones. We therefore conclude that there is one frequency for any particular length of antenna which will result in a wave of maximum amplitude.

Loops—Nodes

On measuring the voltage along the wire we find that at both ends there exists a high potential and practically no current (r.f.). This is because the voltage here varies from zero to a high negative (dense electronic distribution), back to zero, and then to a high positive (scant distribution) and finally

the voltage between the ends drops to zero. The voltage and current are said to be out of phase. Their distribution along the wire is shown in Figure 2.

Half-Wave Antennas

Suppose, as an example, we wish to install an antenna system to radiate on 3520 kilocycles. Since the velocity of an electric wave along a wire is approximately 300,000,000 meters per second, it will travel 85.2 meters before the next wave starts according to the following formula:

$$\frac{300,000,000}{3,520,000} = 85.2 \text{ meters}$$

If the antenna is cut to approximately 42.6 meters, the wave travels to the opposite end and back just in time to be reinforced by the next wave. This length of wire will then be suitable for a wavelength of 85.2 meters with maximum amplitude. This is called the fundamental wavelength. It is the lowest frequency to which this type of antenna will respond. The above shows us that in the case of a half-wave antenna, we will have a point of high voltage at each end and a point of high current at the center.

Harmonic Operation

If the length of a half-wave length antenna is doubled, we can again cause it to oscillate at the same frequency as before. It will now be a full-wave antenna. The same result is obtained, of course, when the frequency which we are supplying to the aerial is doubled and the length of the wire is kept constant. Let us investigate the theory involved now.

Figure 3 shows the diagram of a full-wave antenna. Assume a wave to be started at A. This wave will travel to the right and will be at B at the exact instant that another wave is starting at A again. Both waves now travel in opposite directions and since they travel at the same speed, they will naturally meet at C, the center of the wire. The result will be that the electrons will accumulate and become of denser distribution as we approach the center. We will have a high negative potential point here and a high (Turn to page 314)

back to zero. This process repeats itself as the electrons travel first in one direction and then another. An r.f. voltage indicator such as a neon bulb will glow brightest at the ends of the aerial (voltage loop). At the center of the aerial the electrons are not densely distributed and here the r.f. voltage will be a minimum (voltage node).

Conversely, at the center, the largest number of electrons are in actual motion (current loop) for they are here equally distributed and little impedance is offered to their movement. At the ends, no current can pass through the insulators so that the current here is at a minimum (current node).

A maximum voltage on the ends appears at the same instant that the current drops to zero in the wire. A maximum current exists at the instant that

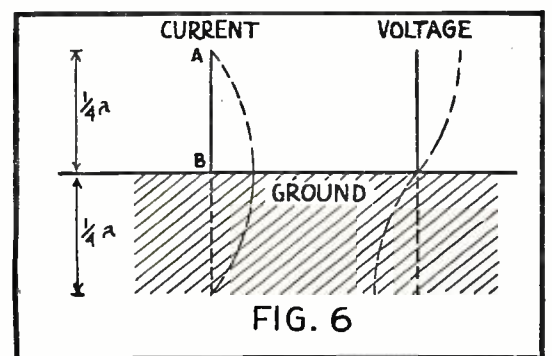
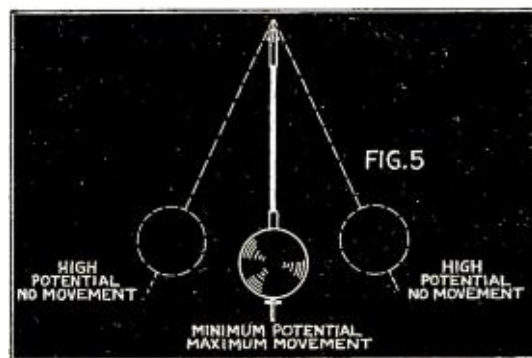
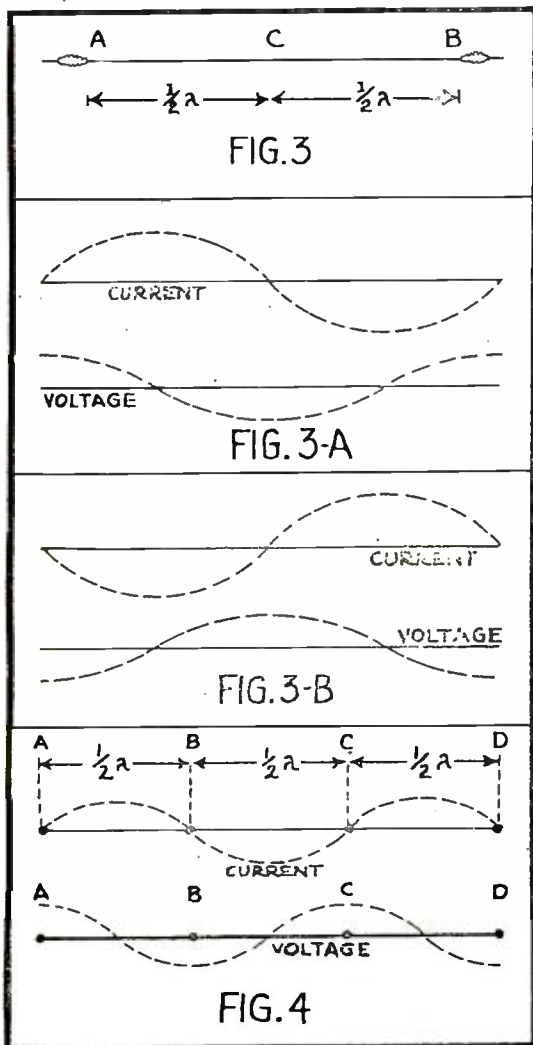

WHAT'S NEW in RADIO

By The Associate Editor

New Radio Outlet

A convenient wall outlet for noise-reducing or "doublet" antennas was recently announced by General Electric Company. The new outlet has three slots in the upper portion for ground and antenna connections and the conventional receptacle in the lower portion for the power plug. A metal divider is attached securely to the body of the outlet to separate the low and high tension circuits in the switch or outlet box. A special cap is also available, with polarity prongs arranged so as to prevent antenna and ground circuit from connecting with the power side of the outlet.

Noise Reducing Antenna Operates 1 to 16 Sets

The following advantages are offered in the RCA "Magic Wave" antenna system—



easy installation, flexibility of operation, noise reducing feature, and others. It can operate up to 16 sets simultaneously when used with the special distribution and coupling transformers, it is easily installed with various antenna lengths from 20 to 120 feet and it can be adapted to many different types of installation, vertical and horizontal for the apartment house or home.

New Line of Exponential Horns

The Wright-DeCoster stadium model MX2800 exponential horn, illustrated below, equipped with a 12 inch speaker has a cut-off frequency of 180 cycles. This horn is intended for use where voice reproduction is the prime requisite. The manufacturer of these new horns points out that they are truly exponential and should not be confused with the so called parabolic type.

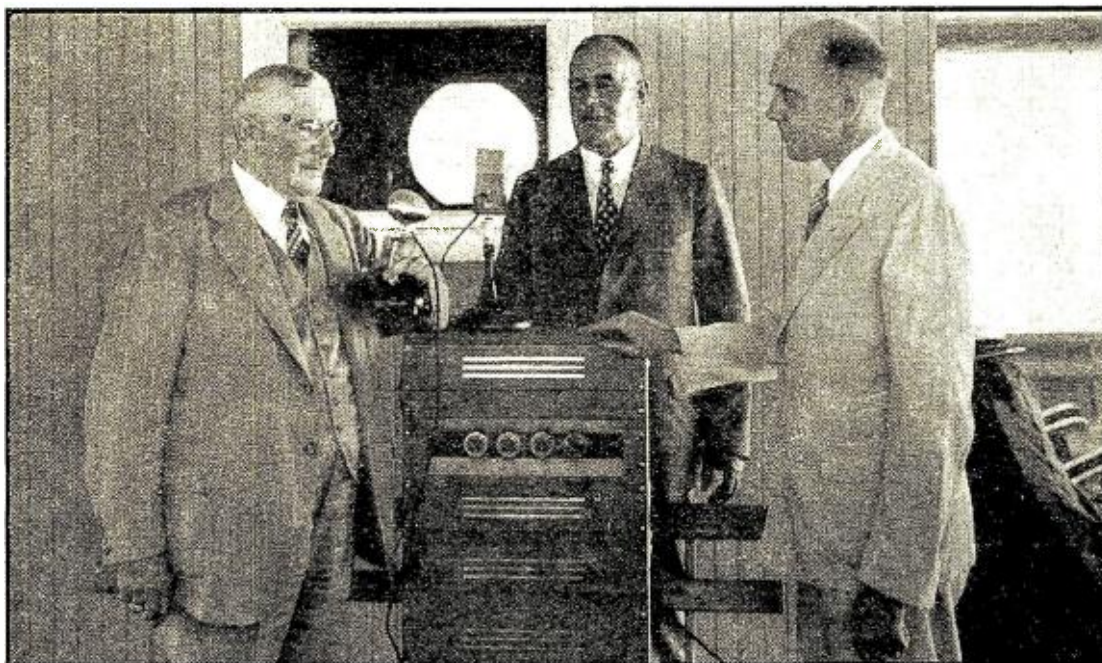

POWERFUL SOUND PROJECTOR

At top: Atlantic City tests RCA's new high-powered public-address system. At left: Director of Public Safety, W. S. Cuthbert, Dr. C. L. Bossert in charge of the beach patrol and W. L. Rothenberger. Picture at right shows the loudspeaker suspended during test. It projected powerful beams with clear speech a distance greater than a mile away.

They are spun from steel and have an especially prepared material called "ex" which is used for coating the outside of the horn so as to dampen the walls to a point where resonance is negligible.

World-Wide Electric Clock

The new Gordon Specialties Company's world time clock should have universal appeal for all radio fans and especially the short-wave DX listener. The attractively colored dials are plainly marked with the GMT scale and the standard time scale which gives the local standard time in 24 principal countries and cities around the globe. The small center dial marked with these locations rotates with the hour hand. The clock is also equipped with a second

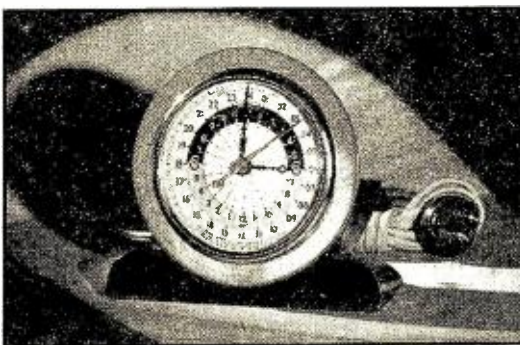

hand and it has a Waltham 24 hour self-starting 60 cycle movement.

A black-satin finished metal base holds the clock in a reclining position for easy reading. The base can be easily removed for panel mounting.

Replacement Controls

Servicemen will appreciate the news that Centralab is introducing a complete line of replacement midget volume controls for the service trade. This new "Radiohm" as it is called, is supplied with a long shaft milled for push-on knobs that require the type of mill ordinarily used for the set screw knob. It is available in all resistance values and tapers from 5000 ohms to 2 megohms. The majority of higher resistance values can be had with tone compensating taps on the resistance strips.

High Gain Mobile Sound System

Here is the new Electro Acoustic Products



Company's "Autovox" 30-watt combination 6-110 volt mobile P.A. system, with a number of new refinements that should recommend it to all sound engineers. It is designed to operate from either a standard 6 volt storage battery or 110 volt 60 cycle a.c. power source. The principal features include par-proof phono. pickup, a new swivel mounted wide-range crystal microphone, two 12-inch Magnavox heavy-duty permanent magnet speakers, separate con-

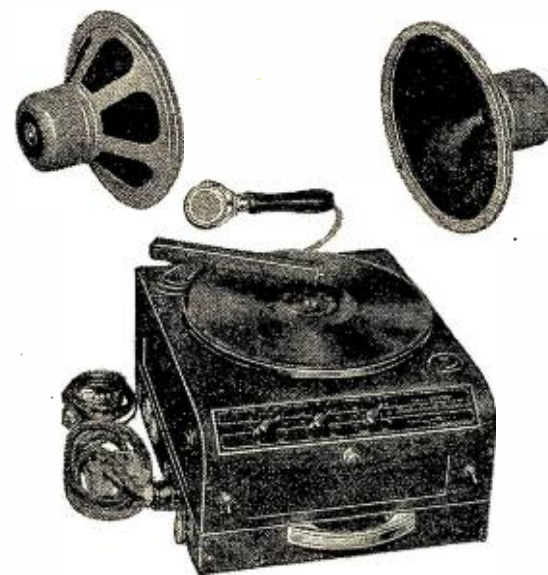

trols and mixer circuit, and other advances. The tubes comprise one 6J7, one 6C5, two 6L6G's, and a 5Z3 rectifier.

Compact 1938 Analyzer with Large Easy Reading Scale

The Supreme model 551 analyzer incor- (Turn to page 318)

Two Full Pages of ROTARY

For the Ultra-

By Laurence

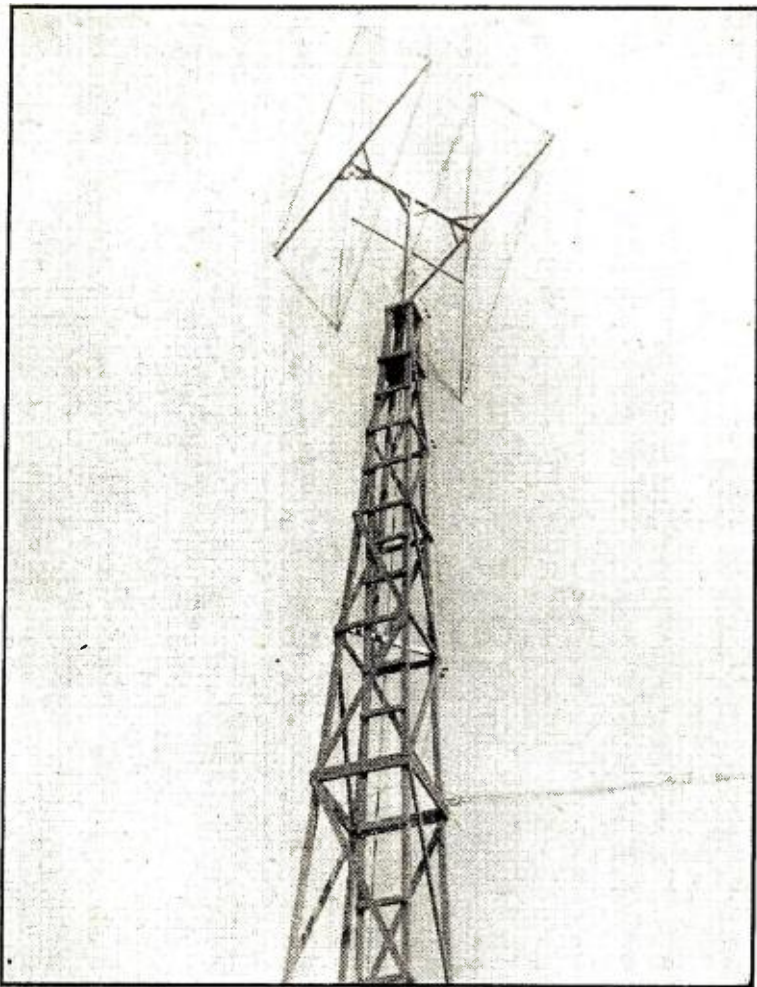

THE "DOUBLE-DIAMOND" BEAM
The 5-meter rotatable antenna and mast in use at W2HWX, Oceanport, N. J.

IT is becoming increasingly evident that the solution to ultra-high-frequency DX communication and the solution to the interference problem, especially on 5 meters, lies in the increased use of efficient beam antennas

that can be rotated in the direction of transmission and reception.

The "double diamond" uni-directional 5-meter antenna described in this short article was developed by Chester E. Sharp, W2HWX, of Oceanport, N. J. The photograph above shows the rotating beam mounted on top of its high wooden tower. A study of this photograph and the diagram below shows that the "double diamond" is a modification of the "H" antenna consisting of four half waves in phase, with the upper and lower legs of the "H" folded in at top and bottom toward the vertical supporting rod. The two upper and lower ends are insulated from each other by insulators. Approximately one quarter

wave in back of the radiator section is another diamond consisting of four wires. These act as reflectors and send the radiated energy out in a pattern illustrated below. The ratio of back to front radiation is 100 to 18, an enormous gain in the desired direction. Mr. Sharp has been experimenting with this antenna for approximately six months and the results with it have proved exceptional, many tests having been conducted with the author at his station in North Pelham. The field pattern shown below was checked at North Pelham and a surprisingly similar pattern reconstructed from receiver input readings in microvolts. The power gain in the favored direction as computed at North Pelham came out as 6 to 1 in the favored direction.

Radiator and Reflector

The radiator section as shown in the diagram is fitted on the end with open-wire feeders with a half wave crossover between each side of the "H." The frame holding the radiator was 8 feet long horizontally and 16 feet long vertically. The four half waves of the radiator were exactly 92 inches long for a frequency of close to 57 megacycles. The actual spacing found best between the rotating diamond and the reflector diamond is four feet one inch.

The reflector diamond has the following physical dimensions, also shown in the diagram. The horizontal supporting rod is 9 feet 6 inches long and the vertical supporting rod is 16 feet 6 inches long. The four insulated half-wave reflectors each have a length of exactly 100 inches. (Turn to page 315)

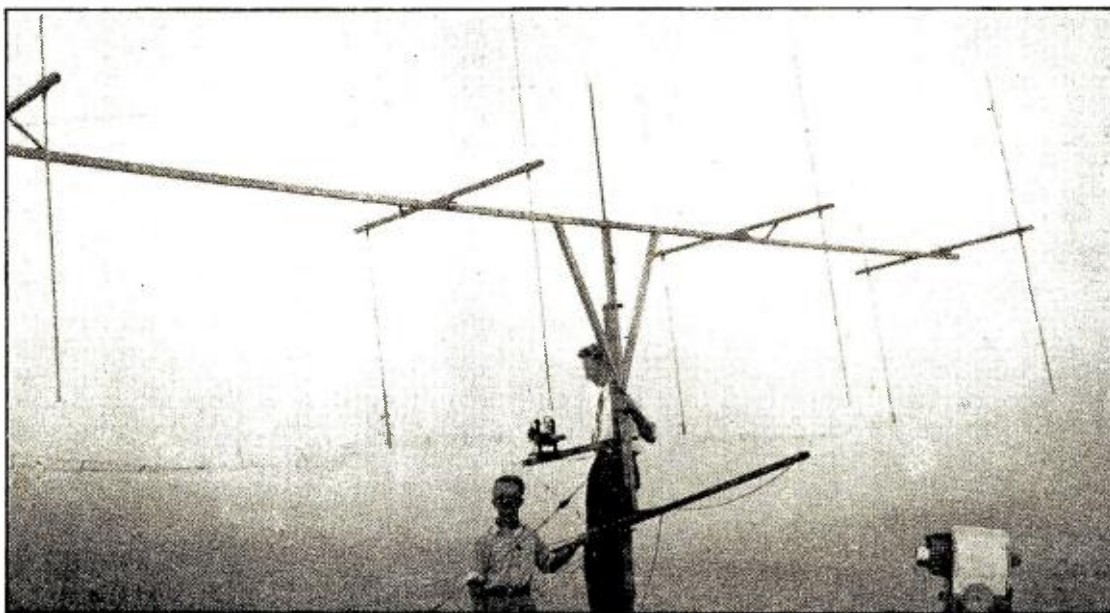

A "BROADSIDE" BEAM
Here is the 5-meter, 4-half-waves-in-phase antenna, used at W3AC. Four reflectors are placed a quarter-wave in back of each half-wave radiator. Radiators are fed with a Hertz, tuned-transmission-line, fed at the center with crossovers to the two outside radiators.

ANOTHER very efficient beam system for 5-meter transmission and reception which is also unidirectional, is this collapsible four half-wave, in-phase "Goyn" antenna, which we have named after its designer, Goyn Reinhardt. Goyn owns and operates W3AC, from the top of High Point Mountain at High Point Park, New Jersey. The altitude there is between three and four thousand feet as will be seen from the photograph.

Reflectors Used

The antenna has, one quarter wavelength in back of each radiator, a similar half-

wave reflector. The ratio of reflector lengths to radiator is 100 percent of a half-wave for the reflector and 96 per cent for the

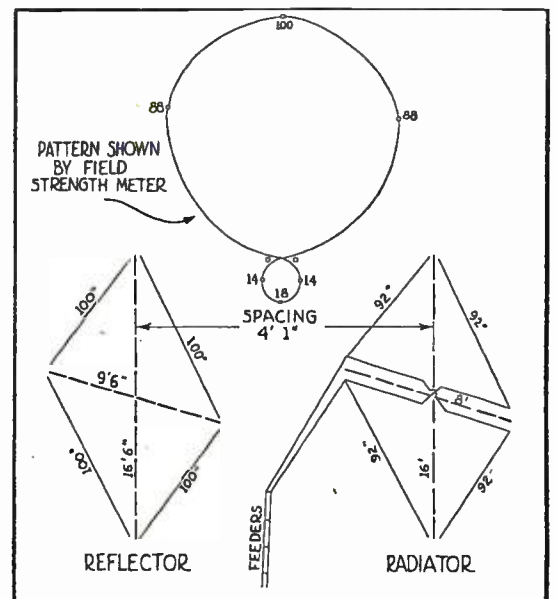

Advanced Data on BEAMS High Frequencies

M. Cockaday

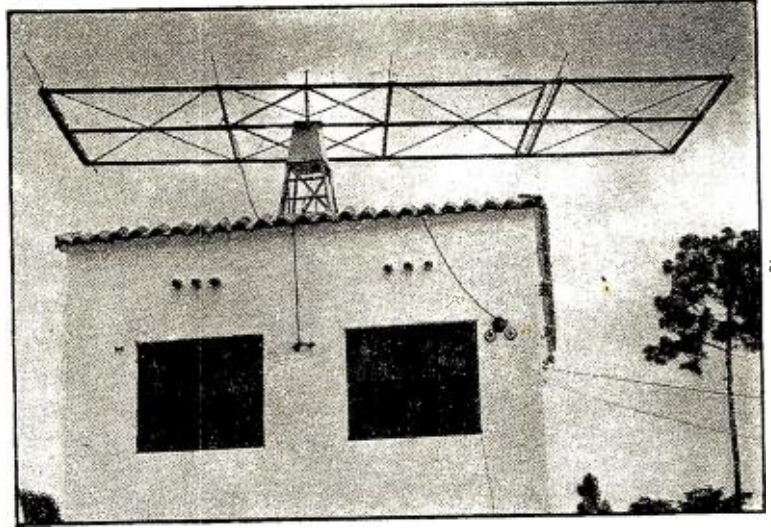

THE matter of 10-meter beams for unidirectional transmission and reception seems to be one in which there is an enormous amount of interest amongst amateurs and experimenters. The beam described here is a really business-like development and one that has proven its worth.

At the top of this page on the right is shown the highly directive unidirectional beam developed by H. H. Robinson, W4EDD of Coral Gables, Florida along with some help and suggestions from Earl Thomas, W2BMK, of Palisades, New Jersey. The beam is shown installed atop Mr. Robinson's experimental laboratories and radio station W4EDD. It consists of a rectangular frame the construction details of which are so clearly shown that we will not describe them further. The electrical part, however, will take some short explanation.

Rotates on Pivot

In the upper photograph at the left is the horizontal reflector rod mounted on three stand-off insulators. A half-wave from this is the radiator half-wave rod which is center fed as a doublet. The Basset concentric feeder material is shown leading down from the center of this rod. The three insulated rods at the right are three directors each half-wave apart and approximately a half-wave long. The whole unit turns on a pivot and the stress and strain is taken

NEAT DIRECTION INDICATOR
W4EDD employs this map indicator, which, by means of a switching arrangement and lamps, shows the direction in which the beam is projecting a signal or receiving one.

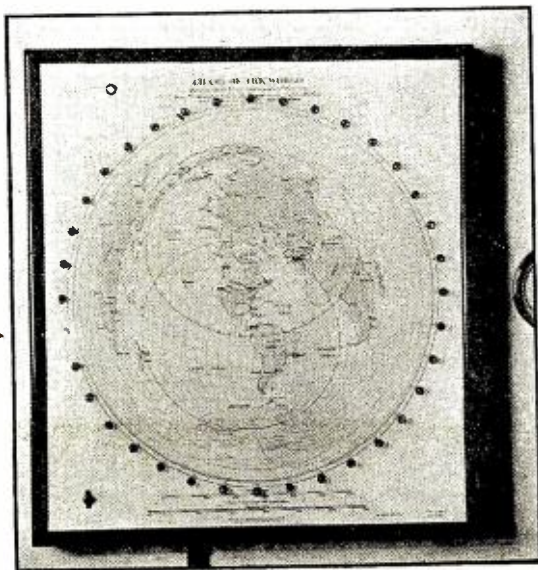

up by guys broken up with insulators. The device is motor driven and controlled from within the shack by a switching arrangement.

In the operating room there is an azimuthal map of the world. Around the periphery of this map is a series of lights, one of which is illuminated as the beam is turned in that direction. Mr. Robinson knows exactly how his beam on the roof is pointing or should point for working in a desired direction out of Coral Gables.

Specifications

Getting back to the antenna itself, the spacing of a half-wave may seem to be rather unique for the directors as well as for the reflectors but actually air tests show that this spacing produces the best signal in the desired direction and the use of three directors sharpened up the beam tremendously. The forward to backward ratio of radiation is approximately 4:1. The length of the rods recommended are as follows: If the

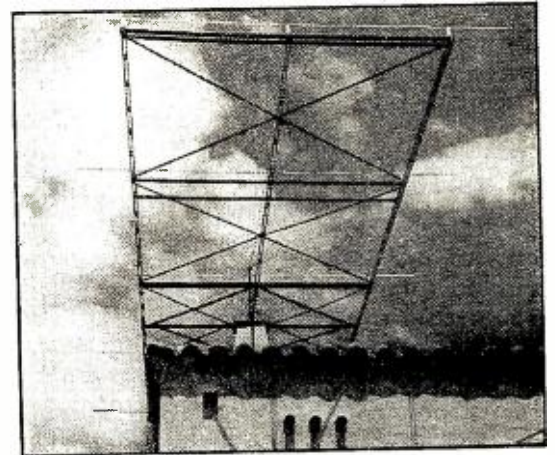

EFFICIENT 10-METER BEAM

The two illustrations above show the side and front views of the W4EDD 10-meter, horizontal, modified-Yagi beam used by H. H. Robinson in his amateur station.

reflector rod is taken as 100 percent of a half-wave length (Turn to page 315)

The H-BEAM Antenna

By Wm. A. Meissner

(W2HYJ)

ONE afternoon we were all over in the shop which is run by Ed Ruth, W2GYL, and the topic of conversation was the failure of most of us to get any real distance, no matter how much power we were using, on five meters. Some of us seemed to be able to do as well with just a few watts as some others of us could do with a few hundred watts. When most of the rest of us had been doing most of our work with what has come to be known as a "matched impedance" type of antenna, Arthur Lynch, W2DKJ, who is Chairman of the Ultra High Frequency Committee of the Garden City Radio Club, was getting some remarkable distance from his portable station, located in the tower at 40 Wall Street, New York. He was using two half waves in phase. His station was more than nine hundred feet above the street and most of us gave full credit for the per-

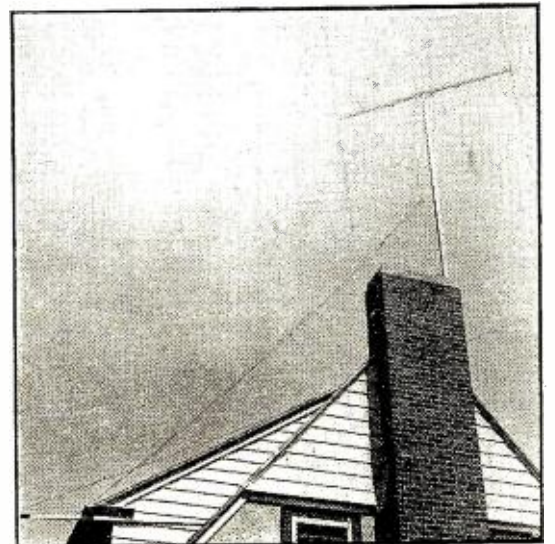

BI-DIRECTIONAL "H" BEAM

The 5-meter, two-way beam installed at W2DKJ, Garden City, is simple to erect and certainly has raised the station's signal in a given direction many R's at distant points.

formance of the station to the height rather than any other factor.

Raising his own power, at Garden City, Long Island, from 70 to 400 watts did not seem to help him very much and the failure of his station to make any real dent in the ether put him in line for a great deal of good-natured kidding. His answer was to the effect that he believed it would be

(Turn to page 308)

How To Build BLACK Burglar

Here is an intensely practical device which is simple to build and serviceman. Used as a burglar alarm,

By Guy

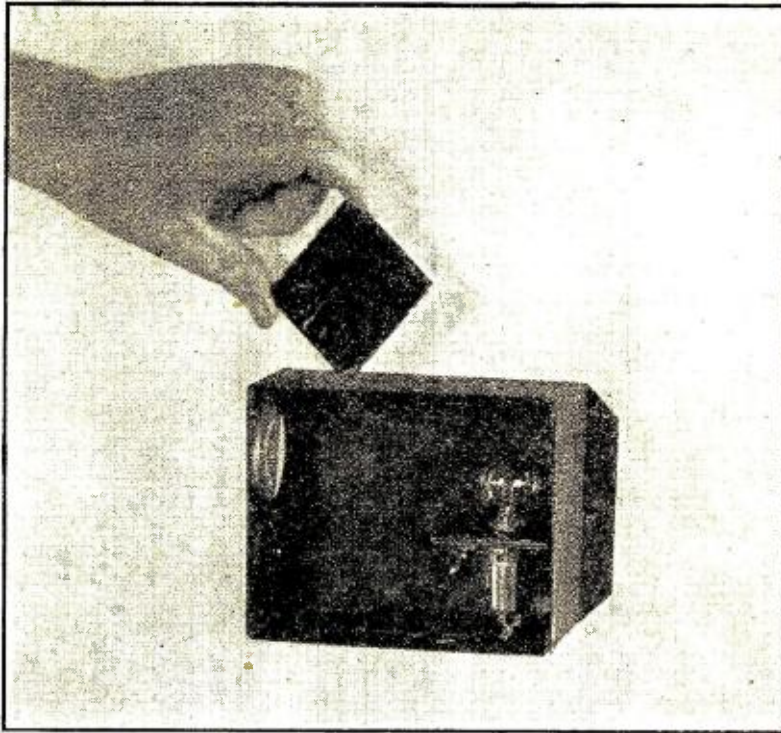

THE "BLACK-LIGHT" UNIT

A 21 c.p. automobile bulb, a lens and a 2-inch square of infra-red filter glass provide the invisible light beam.

A BLACK-LIGHT alarm of the type described herein is thoroughly practical, since similar installations have been used to protect stores, schools, etc., for over two years. It can be worked in as a profitable sideline by radio technicians.

In practice, a beam of infra-red rays is projected across a room or office onto the electric eye, or photo-electric cell. The beam usually is made horizontal and about 30 inches from the floor. If any part of a human body or other opaque object comes into the beam for an instant, so that it is cut off from reaching the 'eye,' the alarm will be tripped and will continue to ring until shut off by an authorized person.

The apparatus can be hidden with only an innocent peek hole showing. The location is not confined to doors

THE EQUIPMENT AND CIRCUIT

Below is the schematic circuit for the complete system, consisting of the two units shown above, plus an alarm bell. At the bottom is the completed equipment, inclosed in cases.

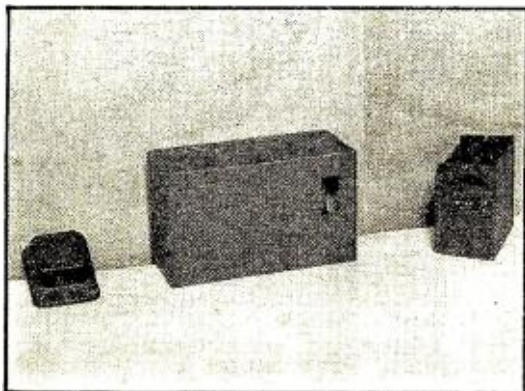
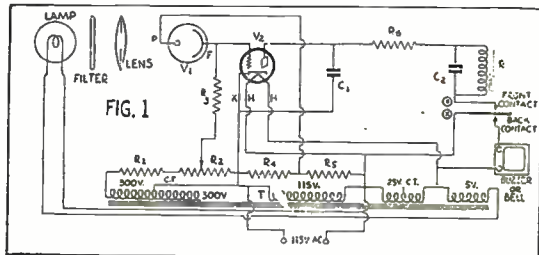

and windows, for the beam may be shot across any portion of a room or store and may be turned around corners by mirrors. Since the alarm might be set off unknowingly by an intruder from almost any spot, a tremendous advantage accrues over older forms of burglar alarms. If bits of propaganda are dropped here and there, it will be found that a 'black-light' alarm actually tends to discourage any such visits.

The equipment is made up in three units: the light source, the photo-

electric cell unit, and the alarm bell. The parts are obtainable from radio mail order houses and other sources as noted on the parts list. The total bill for material will come to less than \$15 for any ordinary installation.

The circuit diagram for the system is drawn in Figure 1. A type 885 gaseous triode is utilized instead of a more common type—a 56 or 76 tube, for instance. Where a 56 tube would require a super-sensitive relay capable of functioning on two or three milliamperes, the 885 gaseous triode will easily pass 50 to 75 milliamperes and operate a simple home-made relay.

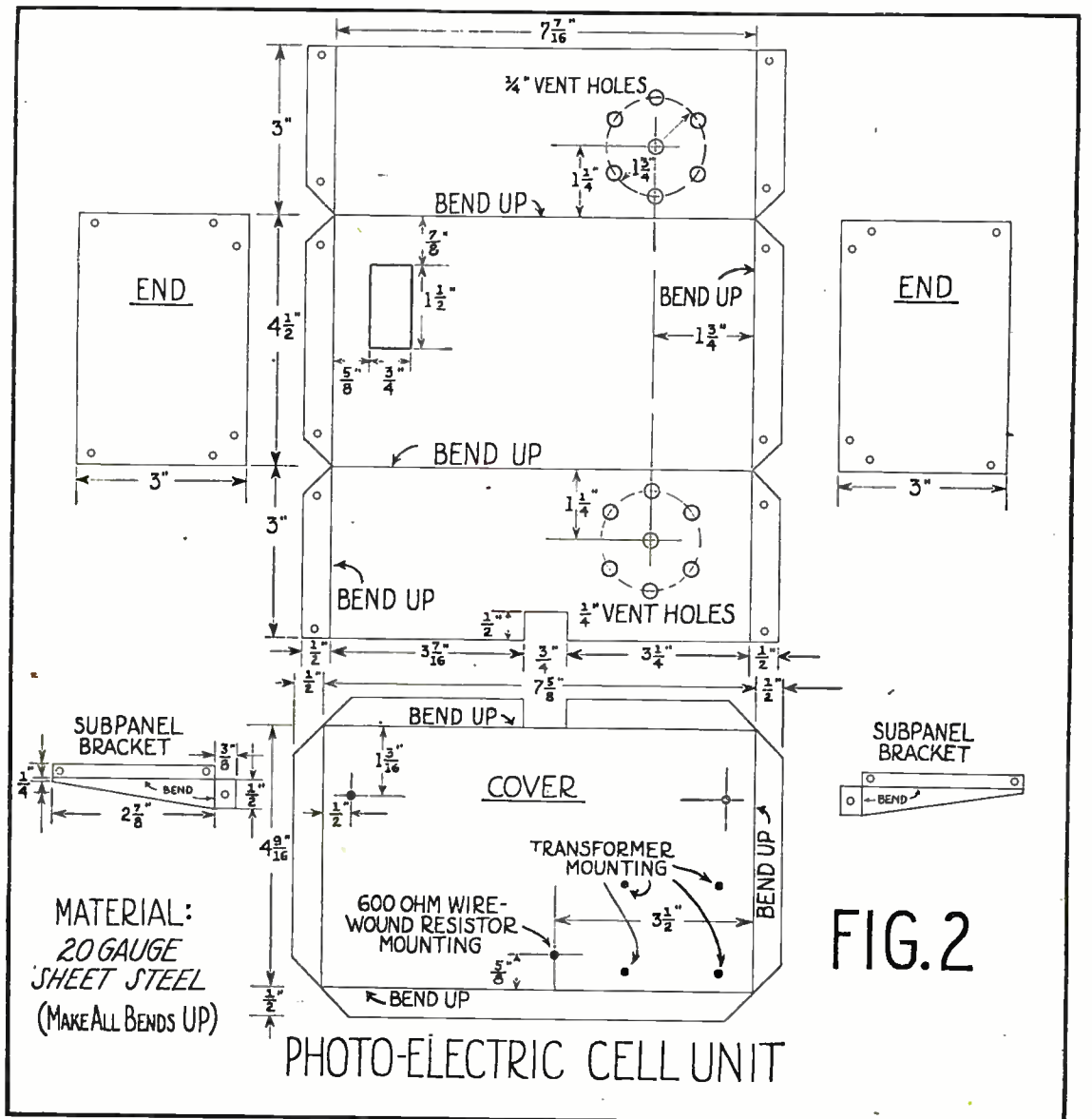

An Efficient LIGHT Alarm

application of the photo-cell in a which offers excellent profits for the indoors or out, it is tamper-proof.

Forest

The photo-electric cell housing is a sheet metal box, approximately 7½ by 4½ by 3 inches, made of 20 gauge galvanized iron or sheet steel according to the sketch of Figure 2. This unit contains the photo-electric, or p.e., cell, the gaseous triode tube, the control potentiometer, the relay, and the power transformer. The latter supplies all the voltages necessary for the whole system. It is the so-called half-shell mounting, 4-tube, midget radio type, with a mounting area 2½ by 3 inches and secondary windings of 5-v. filament, 2.5-volt filament center tapped, and high-voltage center tapped. The half-shell cover should be removed and the transformer fastened end-on with small angles to the box cover. A bakelite sub-panel, (Figure 4), ⅛-in. thick by 2¾-in. by 7-in., mounts on two brackets and carries the tube sockets, the potentiometer, and the relay and filter condenser.

The relay is constructed from an old

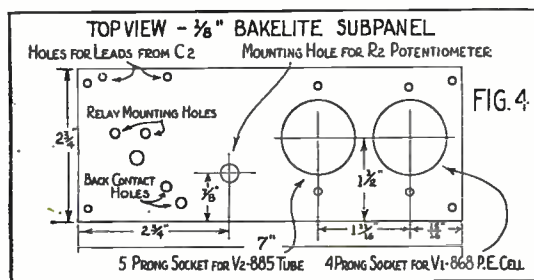
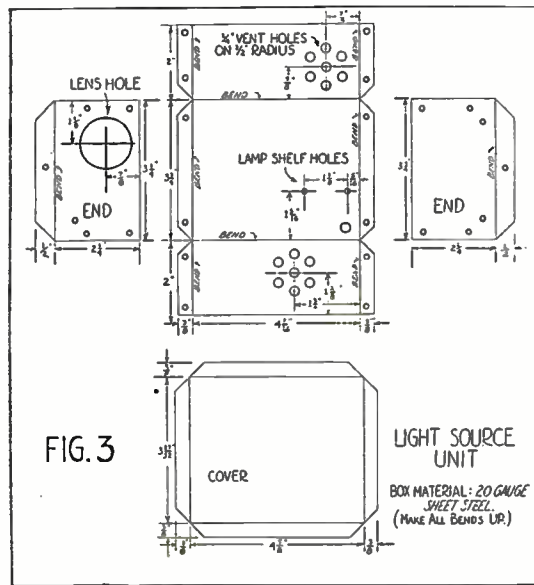

auto generator cut-out. Get one with a good armature and contacts, but the condition of the coil windings is unimportant since they must be removed from the spool anyway. Wrap a couple of layers of paper around the exposed iron core, and then wind the spool full of #36 enamel copper magnet wire. Bring out the ends of the winding separate from the core and from ground. Mount the cutout on its side, using a small angle to hold it to the bakelite subpanel. Make the tension on the armature as small as practical. Obtain the stationary distributor point and mounting as used on a Ford

THE PHOTO-CELL UNIT

A photo tube, amplifier, power supply and relay are all inclosed in a single housing approximately 7½ by 4½ by 4½ inches in size.

Model A distributor, and fix this also on the subpanel so that a back contact for the relay is provided. It is a good idea to clean the surfaces of both front and back contact points, to be sure that good circuits will be made when putting the equipment into operation.

When hooking up the transformer windings, carefully follow the diagram of Figure 1. The windings are all connected together into auto-transformer fashion so as to get the proper voltages and to allow correct relay functioning. The center tap (Turn to page 316)

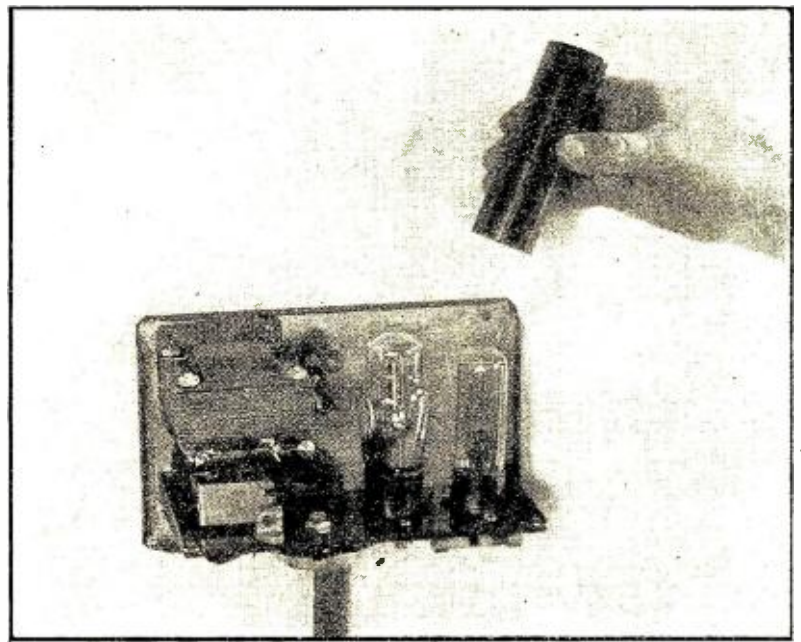

The RADIO Voter

By Samuel Kaufman

THE town of Montclair, New Jersey, will be the scene of the first field tests of the Radiovoter—the device designed by Dr. Nevil Monroe Hopkins which, it is claimed, can accurately measure the number of listeners tuned in to a station at a given time. Also, the instrument can be used to register listeners' votes on their likes and dislikes of program fare.

According to J. R. Poppele, technical chief of Station WOR, Newark, New Jersey, which, along with the Public Service Company of that state is cooperating with National Electric Ballots in making the Montclair test, about 1,000 homes will be equipped with the Hopkins device in a community of 10,000. This, he says, will give an excellent cross-section of the entire section's radio preferences when they are asked to vote on them by means of the Radiovoter.

Dr. Hopkins had announced a similar device at a much earlier date. But he told

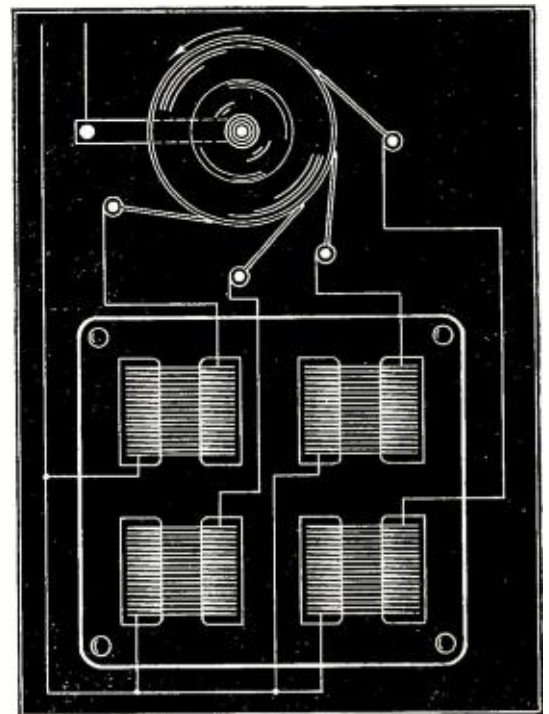

the writer that it now has many refinements and is infallible. A highlight of the instrument is that it can measure the audience without any manual attention on the part of the listeners. But when they are asked to vote "Yes" or "No" on any discussed topic they will press a button attached to the set.

The Radiovoter is mounted in a small case about 4 inches in each dimension. A tone signal of a special frequency will be (Turn to page 299)

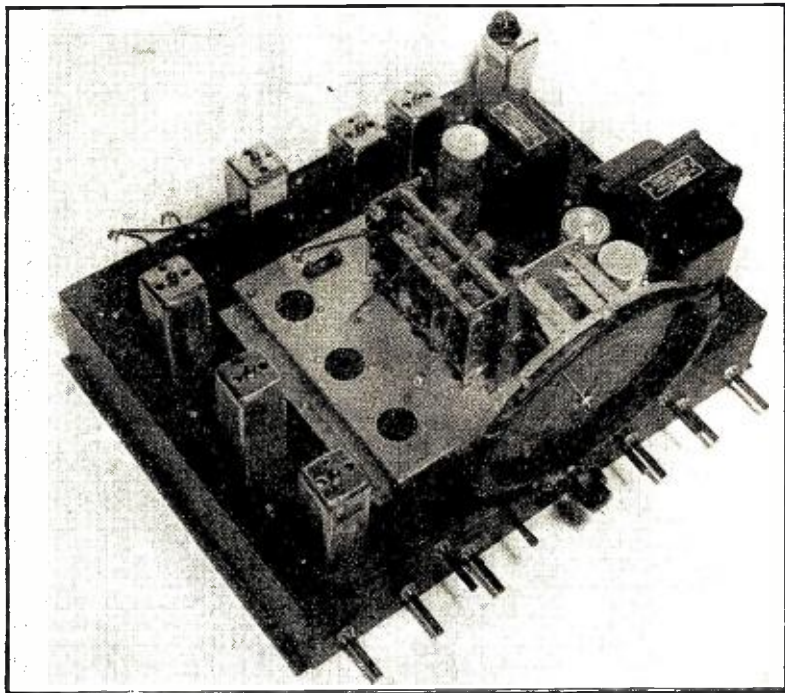

THE COMPLETED RECEIVER

A top view of the receiver, without the tubes. This shows the general arrangement of parts on the chassis.

A Real Set-Builder's The Communication

Here is something for which many "dyed-in-the-wool" set-builders have been looking—a 14-tube, 5-band "Communication type" receiver of professional appearance that can be constructed from components available on the open market.

THOUGH designed primarily to meet the exacting requirements of long-distance communication under adverse conditions, the high fidelity and high power output features of the finer broadcast receivers have also been incorporated. In fact, so far as practical, every proven development in circuit design which will contribute to superior performance has been included. Where any of these improvements require a variable control for maximum efficiency and ease of adjustment, then that control has been placed at the front of the chassis where it belongs. This results in a design utilizing eleven variable controls, each conveniently at hand. Needless to say it is not necessary to twirl all eleven controls to tune in a station, but the greatest possible control of the receiver's capabilities for differing conditions of reception is available.

may be varied at will from the razor-sharpness of crystal filtering, required for communication work, to the extreme broadness necessary for high-fidelity reproduction, by means of electrical band-expanding transformers. The built-in Lamb noise-silencing system enables reception of c.w. under most adverse conditions. Amplified a.v.c., a beat-frequency oscillator, and r.f. amplification on all bands down to 10 meters are included in this new design, as well as provision for an "R" meter, if desired. The audio system, which generally is given little attention in strictly communication receivers, incorporates push-pull beam power 6L6's so

THE selectivity of the i.f. stages of this new receiver design

that full advantage of the high-fidelity features may be realized.

Double Chassis Used

The mechanical design involves the use of a main chassis and a sub-chassis assembly. The main chassis carries the i.f. units, audio and power supply components. The sub-chassis carries the all-wave tuning unit.

The 8-inch oval tuning dial has a scale for each band, calibrated in kc. and mc. A secondary circular scale and indicator located near the center of the tuning dial gives excellent mechanical band-spreading, ranging from over 3 inches travel on the 20-meter band to nearly 27 inches on the 5-meter band.

The circuit diagram of the tuning unit is shown in Figure 2. Here three metal tubes are used with a 260 mmfd., 3-gang, low-minimum-capacity tuning condenser in conjunction with five sets of coils

FIGURE 1: WIRING DIAGRAM

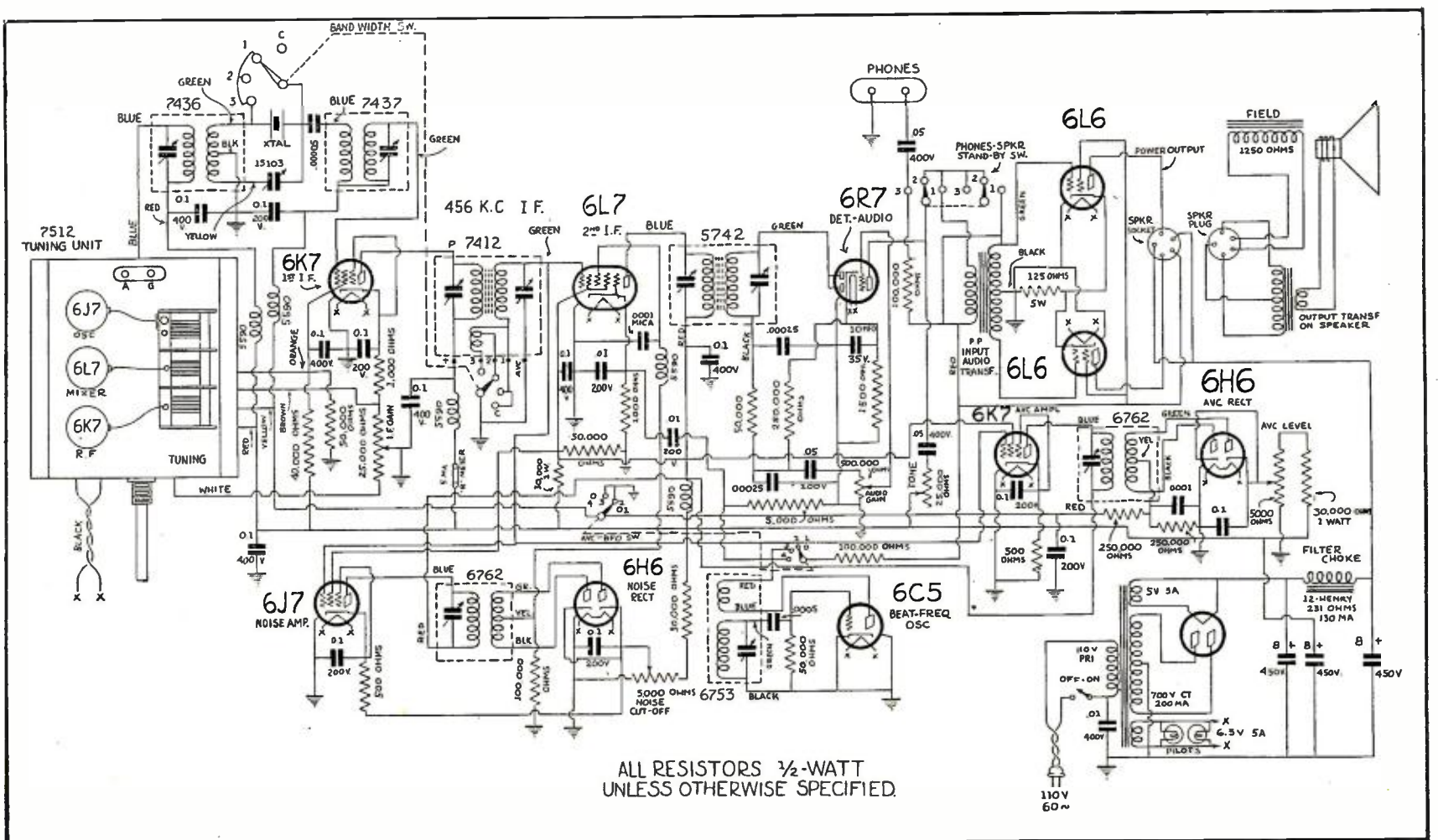

ALL RESISTORS 1/2-WATT
UNLESS OTHERWISE SPECIFIED.

Special! "14"

(Meissner "Communication" 14-5 Kit)

By Clifford E. Denton
(Part One)

with air trimmers designed to cover ranges extending from 550 to 60,000 kc, without "skip".

The use of the 6J7 tube as the oscillator in conjunction with the 6L7 mixer tube provides a very stable circuit combination with high conversion conductance for the mixer stage.

The Circuit Employed

A complete circuit diagram of the receiver is shown in Figure 1. Here the detail of the crystal filter with its impedance-matching transformers and phasing condenser is indicated before the input grid of the 6K7 first i.f. tube. The plate of this tube is connected to an iron-core type, variable electrical band-expanding transformer which in turn is coupled to the 6L7 second i.f. tube. The grid circuit of this 6L7 tube also connects to the 6J7 noise amplifier tube and the grid of the 6K7 a.v.c. amplifier tube. The 6R7 tube serves as a second detector-amplifier with its triode output transformer-coupled to the push-pull 6L6 power stage.

A 6C5 tube is used in the b.f.o. circuit in a conventional manner. The pitch of the beat note is adjusted by variation of the small knob located on top of the b.f.o. coil can.

The i.f. band-width switch provides four positions which can be designated as crystal (C), selective (1), medium (2), and high-fidelity (3).

High Power Output

The a.v.c.-b.f.o. switch has four positions which permit operation of the receiver with or without a.v.c. action when using the beat-frequency oscillator or with it disconnected.

The 3-position stand-by switch serves to adapt the set for operation with either loudspeaker or head-phones or temporarily to kill reception while transmitting without disturbing other connections.

The power-supply unit is standard in design, using a 5Z3 rectifier and a two-section filter. The speaker field is used as one section of the filter and any large speaker having a field resistance between 1000 and 1500 ohms will be satisfactory. It is advisable to use a high-quality 12-inch speaker capable of handling 12 to 14 watts as the output on the broadcast

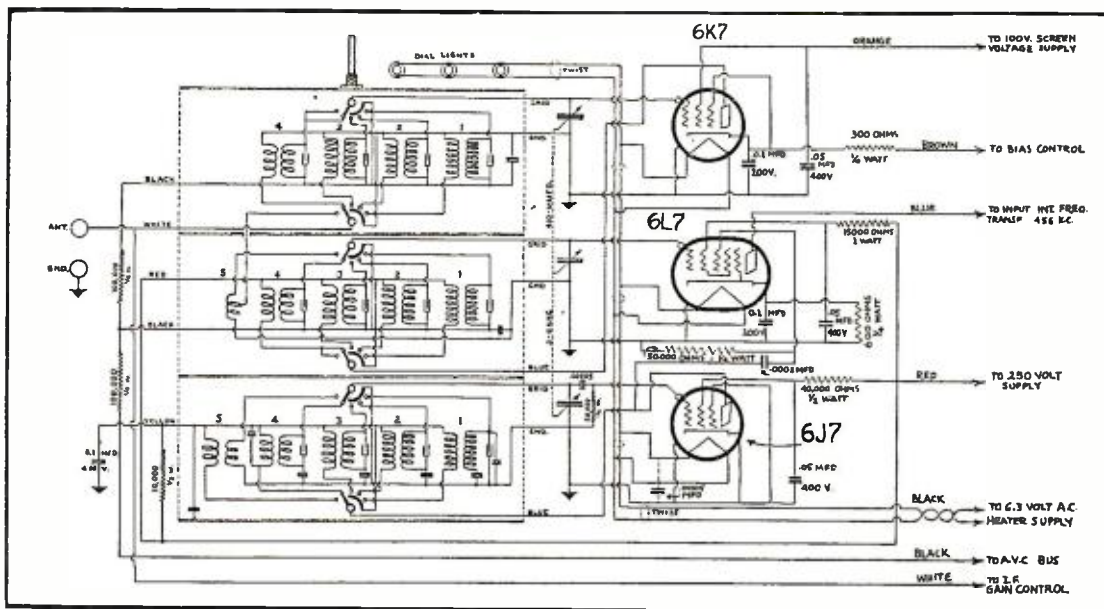
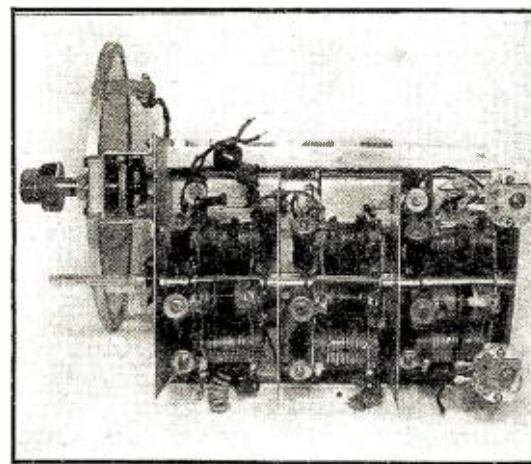
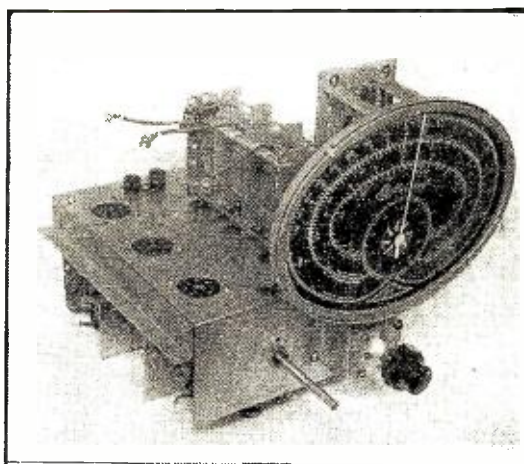

THE R.F. UNIT

Figure 2: This unit, including the r.f. stage, oscillator and mixer stages, is provided completely wired and approximately aligned. Above are shown the top and bottom views and the circuit diagram, Figure 2.

band can be brought to a high level.

The first step in the construction of this receiver is the preparation of the chassis and the mounting of the various component parts in their proper places. The chassis is available ready-drilled, folded and lacquered, or complete drilling specifications may be obtained from the booklet of instructions put out by the tuning unit manufacturer.

Wiring Precautions

The parts list should be studied very carefully and all materials should be on hand before beginning assembly.

Be careful in making ground connections. It is better practice to scrape the chassis at the grounding point and make connections between chassis and terminal

BELOW DECK

This photograph shows the location of the major parts under the chassis and will help to provide some idea of the wiring.

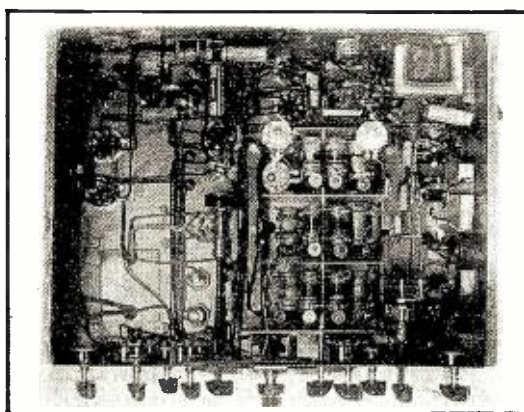

of unit to be grounded with a short length of tinned copper wire.

The wiring of this receiver should follow as closely as possible the pictorial layout in the instruction booklet. All leads should be kept short and direct with grid and plate leads laid close to the chassis and separated from each other. Wire the filament circuits first, using No. 18 gauge or larger tinned copper wire.

Construction Hints

The remainder of the wiring may be completed in any order that pleases the constructor as long as the various parts are placed in their proper locations as indicated in the layout. It is easier to mount the tuning assembly last as this will provide more working room in the chassis for socket wiring, etc. The power transformer and push-pull audio can be mounted at the same time as the tuning unit so that the heavy bulky units which complete the receiver are added after most of the work is completed.

Tuning Unit Pre-wired

The complete schematic diagram of the tuning unit is shown in Figure 2, and includes all parts furnished with the unit. The antenna and ground terminals are mounted directly on the unit and internally wired to the assembly. Only six connections are brought out of the unit to be wired to the rest of the receiver. These leads are color-coded and are indicated in Figure 1. (Turn to page 292)

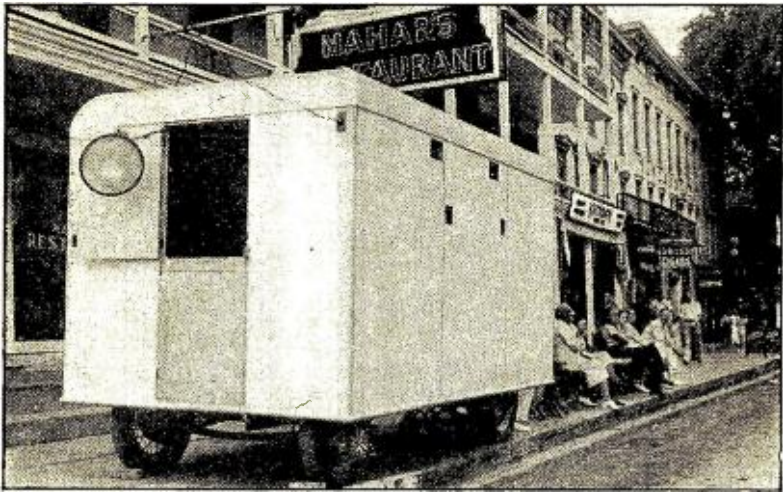

FIGURE 1. OUTDOOR MOVIE PROJECTION BOOTH

The SERVICE BENCH

A 'DOUBLE-BARRELED SERVICE SIDELINE

DDOUBLE-BARRELED because it advertises the serviceman and at the same time brings him in a quite acceptable additional income during the fall months. True, the summer is over as this goes to press, but there is just a comfortable length of time in which to promote the idea and acquire the essential equipment.

THE idea is simply a free weekly outdoor presentation of motion pictures as exemplified in the original conception and execution at Schoharie, N. Y. The town bears all the expenses—purchases most of the equipment and rents the P.A. system from a local serviceman who is also paid for staging the show. In the case of Schoharie, the serviceman is Edward Scribner, a frequent contributor to RADIO NEWS. The village is amply repaid for its expenditures by the thousands who flock to Schoharie every Thursday night and who necessarily patronize the local merchants—not to mention the hot dog, peanut, pop corn and hamburger stands, soda fountains, liquor store and bars. To make certain of attracting the younger and more money-free element, a street dance is staged simultaneously with the free movies. Several hundreds of camp chairs are also rented at ten cents each for the comfortable viewing of the show.

A Special Trailer

A special trailer was built to house the projection equipment, amplifiers, mike and turn-table. This is shown in Figure 1. There are no springs on this trailer, thus making it unnecessary to block it up during the performance. The projection booth is located directly across the street from the County Court House, the lawn in front of which helps provide adequate projection distance. The Court House is shown in Figure 2, and the screen will be seen rolled on the grass. This is raised by ropes directly in front of the lights with the speakers slightly to each side. Ordinarily only the four large speakers are employed which provide adequate coverage for an audience of several thousand.

Figure 3 shows one corner of the interior of the projection booth, illustrating the amplifier, turn-table and Astatic Tru-Tan pick-up which provide a high quality of recorded entertainment for a period of an hour or so before it is dark enough for the pictures.

Aside from the cash income for operating the projectors and renting the P. A. system, the serviceman benefits almost as directly from the advertising and publicity afforded by his association with the enterprise. His

public-address equipment rarely "collects dust," and he is the logical person from whom to purchase radios, electrical appliances and related service.

It should not be a difficult task to put over this idea in any progressive community with a population of 1200 or better. The town board need only be convinced that the scheme is profitable and it shouldn't require much more than a blunt pencil to demonstrate what a weekly invasion of several thousands in a buying mood can do!

The objection will usually be brought up concerning the possibility of rain—which objection has in no way curtailed the success of the venture in Schoharie, where the free movies have been run in the open air since way before the days of talkies. They ran two consecutive summers and falls without a single rainy Thursday night—actually running forty-seven consecutive Thursdays without rain. On the few occasions of rain, the pictures are presented inside the local theater—*still free!* Why not try it out this fall or at least make plans, now, for next summer? If any one wishes actual data on expenses involved—policing, films, lights, projectors, booth, incidentals, etc.—drop a line to the Service Editor of RADIO NEWS.

THIS MONTH'S SERVICE SHOP

Plenty of room, adequate equipment and a generous supply of light go a long way toward establishing success in any technological field. Our Service Shop for the month (Figure 4) stacks up well on these important counts. The shop is that of

Vance Lind, St. Paul, Nebraska. He tells an abbreviated but interesting story himself: "It was impossible to get all the Service Bench in the photo. To the left (and out of sight) is a complete Bench equipped for servicing battery sets—automotive and 32-volt designs. We have quite a few of the latter in these parts. Out of range to the right are parts bins and a new point-to-point analyzer. All of the panels on the Bench—which include practically every worth while bit of testing equipment—are removable so as to facilitate change or modernization at any time.

A "Young" Old Timer

"I'm not so old, but still rate somewhat as an old timer. I remember when the editor of RADIO NEWS was running POPULAR RADIO magazine and that dates a while back. I still have some of the 1924 issues. I am a graduate of the R. C. A. resident school in Chicago. That sign to the right means exactly what it says—'minimum labor charge, \$1.50.'

"Incidentally, the population of our town is only 1621, but we do a lot of work for dealers within a radius of better than a hundred miles."

Vance Lind tells us that he has a few other innovations in his shop and if we're interested he'll send along the dope. We sure are, Vance—so let 'em ride! And that goes for all you servicemen with something new!

THE DAY'S WORK

Arthur Strand of Baltimore, Md. sends us the following dope on—

PLENTY OF ELBOW-ROOM IN THIS SERVICE SHOP!

Figure 4. Vance Lind's Service Shop at St. Paul, Neb., features this well-laid-out Bench fitted with all the necessary conveniences.

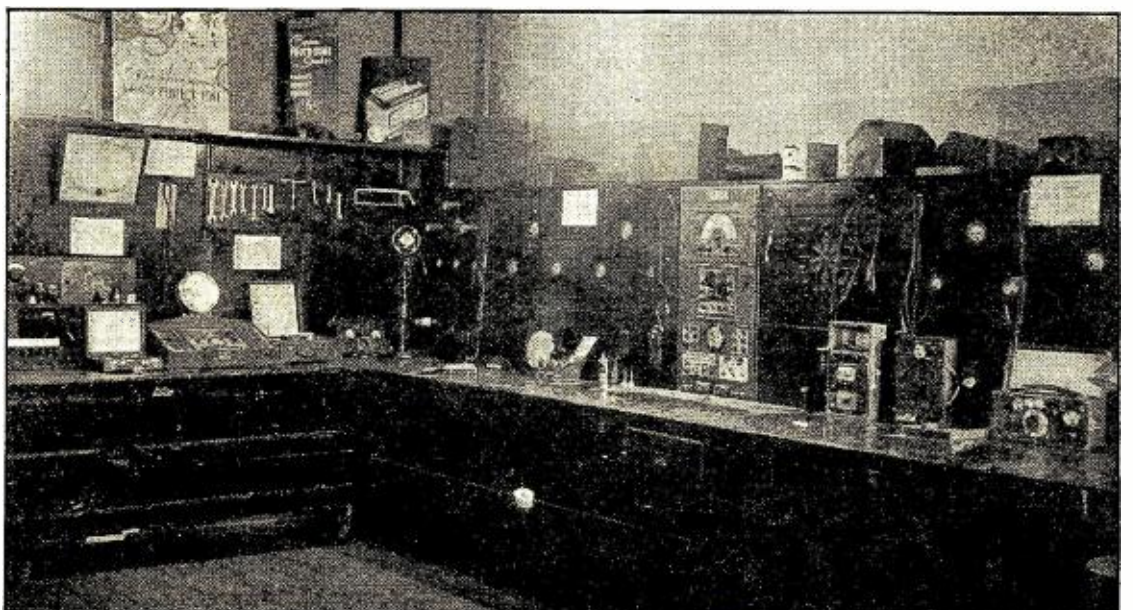

THIS MONTH

Novel Sideline . . . Service Shops . . . Mail Order Sets . . . Battery Sets . . . Majestic . . . Belmont . . . Service Notes

**By Zeh Bouck,
Service Editor**

Unknown Brand Receivers

"I'm not knocking all goods sold under unknown 'Brand' names, but there's no doubt about it that many of these sets are not what they should be due sometimes to careless construction (particularly in the wiring) and lack of inspection and test. Some of these sets are never tested—or certainly they wouldn't be sold. These receivers are made for various dealers or other sales organizations by different manufacturers who apparently are negligent so long as their names are not tacked on the chassis.

"I have had many complaints from clients who have bought such receivers, hooked them up in accordance with directions, and then sat down to listen to Shanghai—but couldn't even get a local station. My first check is always on tubes. Some of the tubes sold with such receivers are a lot of grief. Then I used to give the chassis a

Figure 3. Inside the projection booth, showing the amplifier, turn-table and Tru-Tan pick-up.

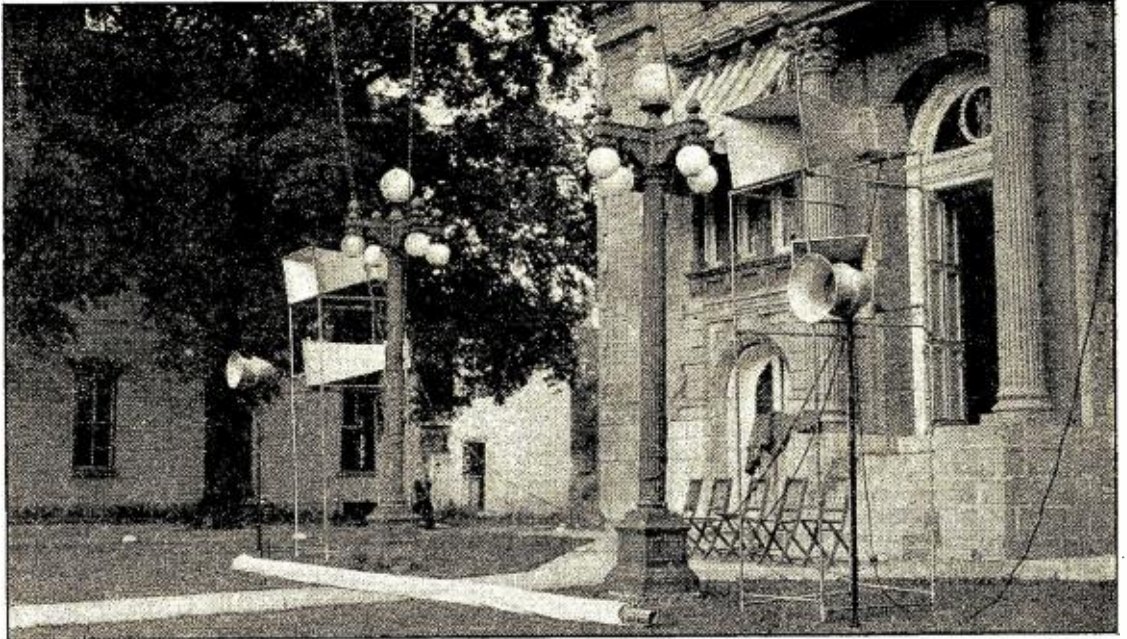
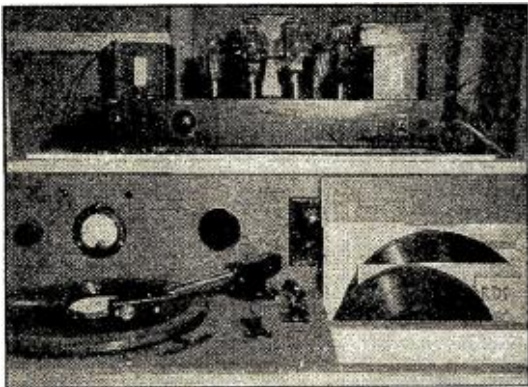

Figure 2. The screen is suspended in front of the Court House.

regular going over with test equipment. I have found, however, that I waste a lot of time doing this. A good visual inspection is next in order after the tube check. In the majority of cases you will find a by-pass condenser that has never been connected—or a resistor that is not performing for the same reason. Sometimes the wires may not even be present! If the complaint is noise, the trouble will more often than not be traced to an unsoldered connection. If one band is good, and another not (or noisy) check the connections on the wave-band switch. If the set is dead on one band, there probably isn't any connection at all!!!!

"The funny thing about these sets is that they are very good as a rule once you get them working and represent a real value to the consumer . . . unless the service charge runs too high. Hence I advise you to use your eyes before you do the analyzer."

Bias Adjustment in Battery Sets

"During the last few years the use of bleeder networks across a portion of the 'B' battery circuit has become almost standard as a method of obtaining 'C' bias in battery-operated receivers. However, unless the drain through the resistor network is equal to the current consumed by other parts of the receiver, the 'C' portion of the 'B' battery will not discharge as fast as the remainder of the 'B' supply, resulting in an improper bias and distortion as soon as the batteries begin to go down even

Figure 6. An improved circuit which will even up the battery drain.

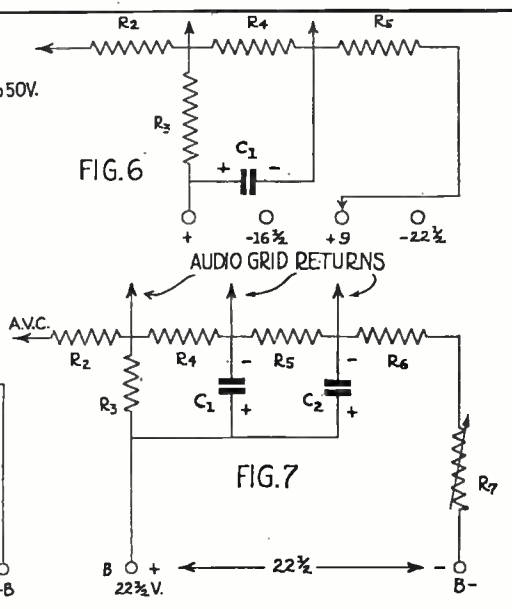

Figure 7. Another way of getting the most out of the "B" batteries.

slightly. In sets using circuits similar to that shown in Figure 5, the 'B' batteries frequently must be replaced when the voltage drops to around 40 volts.

"It is not advisable for the average serviceman to attempt to revamp the bleeder networks. Figure 6 shows a simpler method of overcoming the difficulty by using a tapped 22.5-volt 'C' battery instead of making connections to the 'B' circuit. Another method is shown in Figure 7, which employs a 5000-ohm variable-resistor in series with the network, which tends to move the 'C' voltages toward the positive end of the network. The customer should be warned that the variable resistor should always be set for zero resistance when new 'B' blocks are installed."—Harry D. Hooton, Radio Service, Henderson, West Va. Mr. Hooton, a familiar contributor, also sends us the following item on—

1F4 Output

"When replacing output transformers from 1F4 tubes to permanent-magnet dynamic speakers, especially when the transformer is of the universal type, trouble may be encountered due to a slight mismatching. The writer has found that the distortion and rattling on certain audio frequencies can usually be eliminated by placing a mica condenser from the plate of the 1F4 tube to negative filament. The capacity should be as small as will correct the difficulty—usually from 250 to 2000 mmfd."

Majestic Model 66 Auto Radio

"When working on this set, do not replace the grid caps on the 89 output tube and the 6C7 first audio stage in the wrong order. Unless guarded against, this mistake is the most natural connection, since the leads must be crossed for proper operation. Otherwise the first a.f. stage will be cut out causing a very weak response with apparently everything in good order! The correct connection is shown in the drawing of Figure 8."—George H. Koether, Jr., Severns Park, P. O., Round Bay, Maryland.

The proprietor of "The Little Old Repair Shop", New Orleans, La., checks up on—

Belmont Radio Model 1170B

"A common complaint with these receivers, even when new, is non-operation with tubes checking okay. The probable location of the trouble is in part No. 100.20—a .1 mfd. condenser which will be found at the base of the 6F5 tube. It is connected from the center of two 100-ohm resistors which are hooked in series from the plate of the 6F5 tube to the primary of the (Turn to page 292)

- R1 = 100,000 TO 1 MEG.
- R2 = 100,000 TO .5 MEG.
- R3 = 150 OHMS
- R4 = 1,000 OHMS
- R5 = 2,000 OHMS
- R6 = 2,000 OHMS
- R7 = 5,000 OHM POTENTIOMETER OR RHEOSTAT

C1, C2 = 8MFD (OR LARGER) 25 TO 50V.

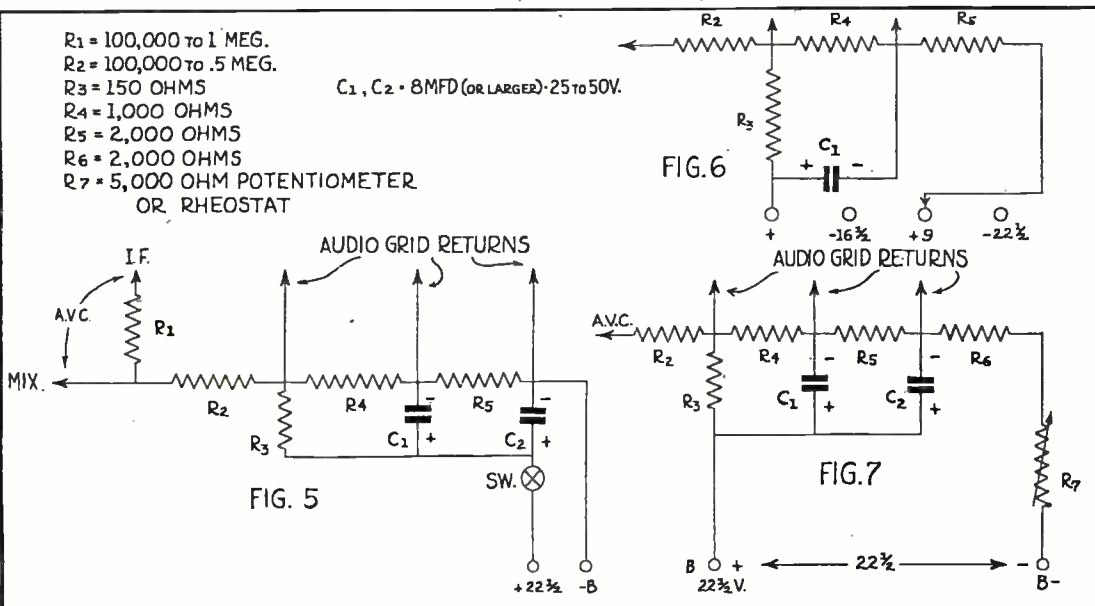
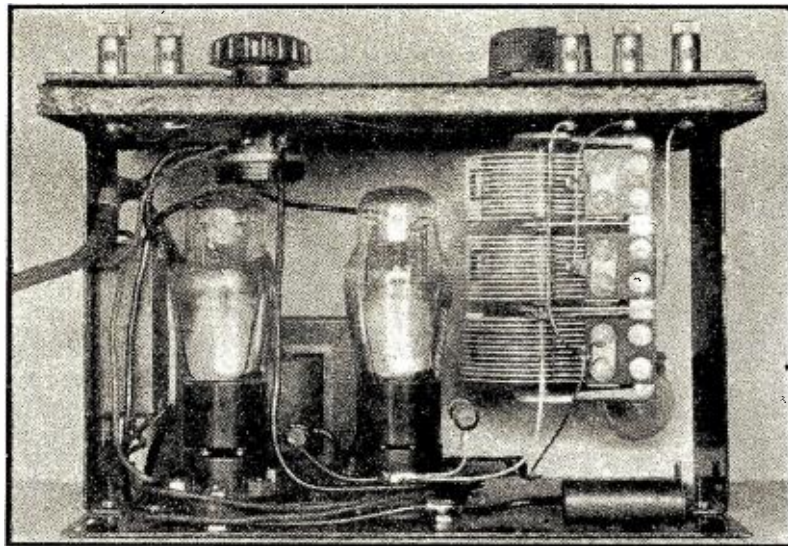

Figure 5. Typical "C" bias network on battery receivers.

Inexpensive, Easy-to-Make NEON-TUBE Oscillator

The gas tube makes an ideal tube for a simple audio oscillator for code use or tone modulation

By Emil Buchwald



A SIMPLE ARRANGEMENT
This inside view of the unit shows the layout of parts for the oscillator.

NEON-TUBE audio-frequency oscillators provide an interesting and fruitful subject for study by the experimentally inclined. They are simple and inexpensive to build and serve many purposes as well as the more expensive types of audio oscillators. They are by no means instruments of laboratory precision character, inasmuch as they do not maintain calibration accurately and their output is not sine-wave. But as a source of a.f. energy for modulating test oscillators, for roughly checking frequency discrimination an audio equipment, for testing modulation and for code practice they are excellent.

The fundamental circuit of a neon-tube oscillator is shown in Figure 1 and the circuit in Figure 2 is that employed in the model shown in the photographs. The frequency is a function of the resistance, capacity, applied voltage and the constants of the tube. To change the frequency any of the first three factors may be varied. In the unit described here the capacity is made continuously variable and provision is made for connecting different resistance values externally. With only two resistors this arrangement permits a coverage of approximately 50 to 10,000 cycles.

Construction

The whole assembly is mounted on a chassis and placed within a small steel box, 9 inches by 6 inches by 5 inches in size, which may be secured from any one

of the radio supply houses for a reasonable sum.

Exact physical dimensions of the layout will not be given since the layout is not at all critical. In fact a bread-board layout can be used if desired, provided precautions are taken to avoid accidental contact with the line voltage. A good idea of the arrangement of the model can be obtained from the photographs. In this instance the chassis is merely a flat piece of No. 18 gauge steel bolted to the top panel with two brackets, so that the whole unit may be removed from the box in its entirety.

The Neon Lamp

To prevent the box from being "hot" all the parts including the variable condenser are insulated from the box and the negative of the B supply grounded to chassis through a .1 mfd. condenser. To avoid losses in the circuit, a socket is not used for the neon lamp; instead it is soldered directly to the stator of the variable condenser with a small strip of copper. The neon lamp is one of the standard 1-watt size and preferably one which does not have a built-in limiting resistance.

The tube line up consists of a 37 amplifier and a 12Z3 rectifier with their heaters connected in series, and in series with a standard line cord resistance of 310 ohms. It operates from either a.c. or d.c. lines. A 10,000-ohm potentiometer in the plate circuit of the 37 serves as a means of varying the output. 0.1 mfd.

blocking condensers are inserted in the output leads so as to isolate the d.c. voltage. The line switch is mounted on the back of the potentiometer, so that this unit serves a dual purpose avoiding the drilling of an additional hole in the panel.

To make the instrument as flexible as possible the three stators of the variable condenser are connected to three binding posts on the panel so that any combination of resistance and capacity is possible to take care of various frequency ranges. For the highest range a 5-megohm resistance is connected between terminals 1 and 3. To extend the range into the medium frequencies a jumper is connected from 1 to 2. For the lowest range, starting at about 40 or 50 cycles a 70-megohm resistance is connected between 1 and 3 with a jumper from 1 to 2. The resistance units may be mounted on small strips of bakelite with banana plugs if desired, to facilitate quick changing. These values are to be considered as being only approximate as conditions and constants vary with different parts used in the construction.

If still lower frequencies—even as low as 1 cycle per minute—are desired, they may be obtained by connecting both a resistor and a larger condenser in parallel between terminals 1 and 3, with a jumper shorting terminals 1 and 2.

THE COMPLETE SCHEMATIC CIRCUIT

Terminals 1, 2 and 3 are brought out on the front panel, as shown in the upper-left hand corner of the photograph (below). This permits changing R4 for different ranges.

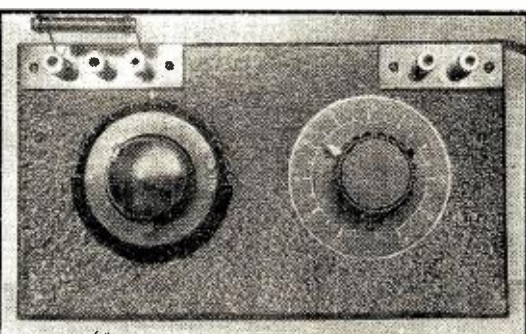
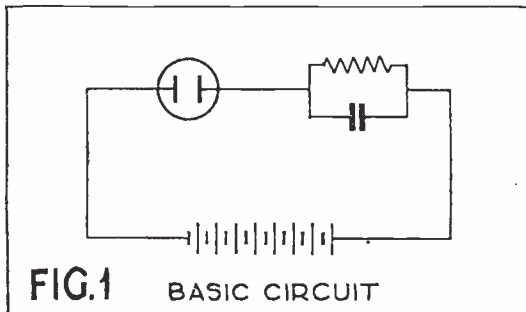
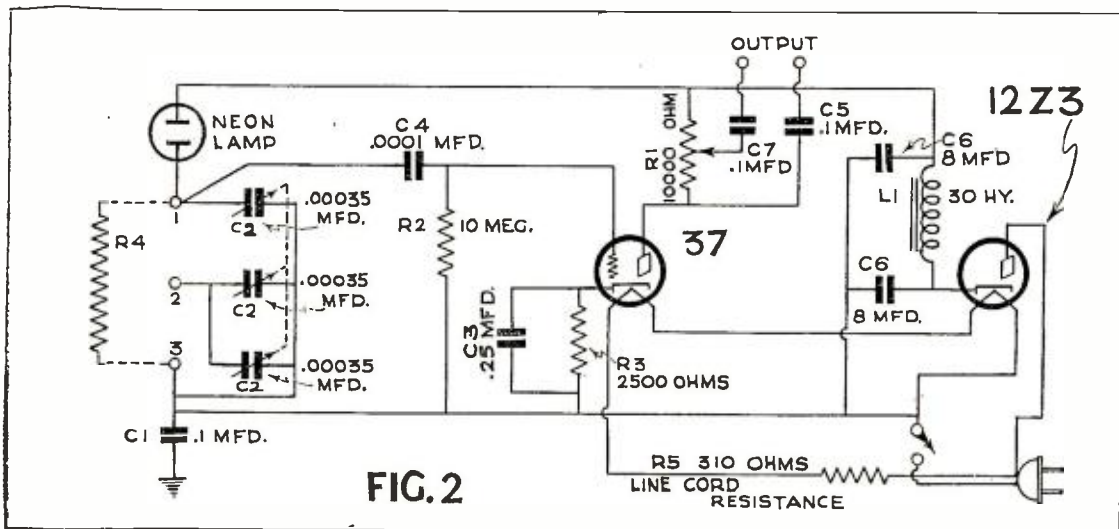

Some Important Considerations for MOBILE P.A.

By Harry Paro

MOBILE P.A. requirements differ substantially from those of any fixed installation, whether indoor or outdoor. The differences found in practice are reflected in typical characteristics of design which distinguish mobile equipment as such. The specific needs to be met by mobile apparatus may be grouped under several headings. For example:

Mobile Requirements

Output Power. Roughly, fifteen watts represents about the lowest power output limit for mobile sound equipment that can compete successfully with moderate traffic noises. For many applications considerably higher output is necessary, since in much mobile work the automobile carrying the sound system moves rapidly past the listener, perhaps through a street in which traffic noise is heavy. A message of appreciable length is partly lost, under such circumstances, unless volume is sufficiently high.

Coverage. Since mobile work is primarily outdoor work, projector-type speaker baffles are favored. Flat baffles give excessive volume near the appa-

ratus, but insufficient volume at the fringes of a scattered crowd. Flat baffles also increase the difficulty of avoiding feed-back when a microphone is used in the truck or car.

Power Sources

Power Source. Four general types of power sources are possible. The ordinary vibrators, as used in auto radios, have inadequate output for high-power P.A. work. The a.c. generator belted to the fan pulley of the automobile or truck has received some degree of acceptance. In the experience of the writer, however, these generators do not respond very satisfactorily to the highly-variable demands of a Class B amplifier, and are not built large enough to provide high volume with Class A amplifiers. A third power source, by far the most common and in general the most satisfactory, is a rotary-converter operating from the storage battery, and supplying the tubes directly, without need for an a.c. power pack. The usefulness of this system is limited by the capacity of the average storage battery, and it becomes increasingly impracticable with audio requirements above 30 watts. For greater volume a standard a.c. system and gasoline-driven a.c. generator are almost always to be preferred.

Dual Usage

Flexibility in operation is a vital economic requirement. The majority of low and medium-power P.A. amplifiers con-

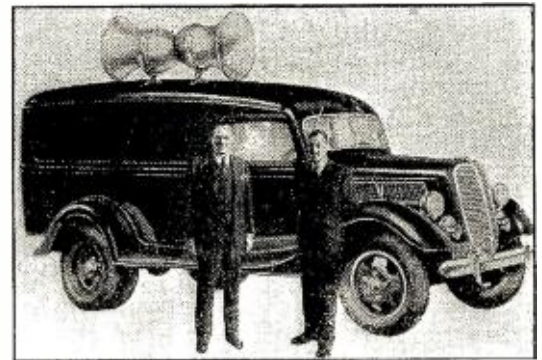
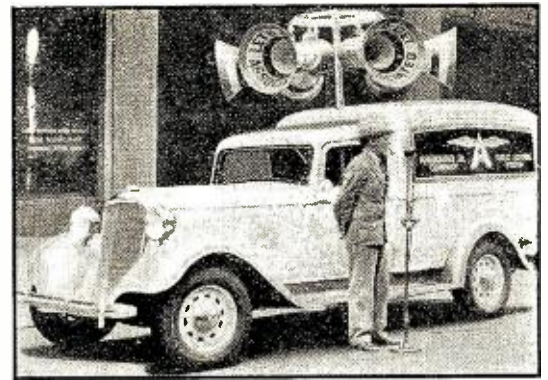

THREE SOUND TRUCKS

Above: Three examples showing method of mounting loudspeakers, for general coverage, for forward projection and for both forward and backward projection

tain built-in rotary converters, the output of which is high-voltage d.c. The great majority of users find that an amplifier of that type constitutes a dead investment during a considerable period of time, whereas if it could be converted to a.c. operation it would yield a much greater return upon its cost. Manufacturers commonly provide power packs for their mobile (Turn to page 310)

INSIDE THE SOUND TRUCK

A serviceable amplifier and a turntable are the heart of any mobile P. A. installation. The illustrations below show the Lafayette Model 321-P portable sound system and the Model 275-A amplifier.

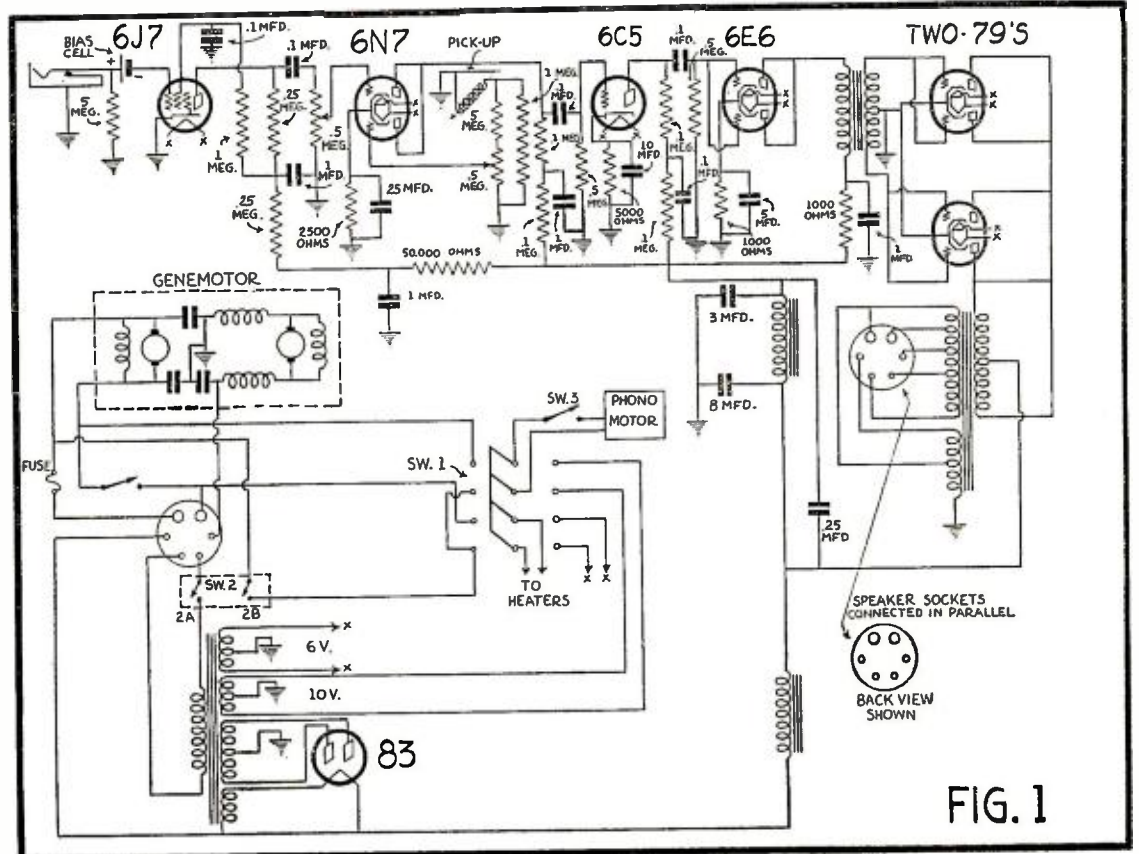

FIG. 1

Practical Pointers for Servicemen on Servicing MOVIE SOUND

(Theater Acoustics)

By W. W. Waltz

(Part Four)

SO many theaters need acoustic treatment that almost anything which can be done, short of a Colonel Stoopnagle-ish job, ought to result in some improvement. About the worst that could happen is that so much treatment might be applied that the theater would become "dead." This possibility is somewhat remote and need not be feared if the few precautions discussed below are observed.

Selling Acoustics

In connection with selling the idea of acoustic treatment, the same resistance will develop as was found to the idea of servicing the equipment. The same remarks apply here with equal force. In addition, the serviceman must never make the fatal error of promising what the results will be. Rather, if one has the confidence of the theater owner to the extent that he is willing to discuss the idea, it may be pointed out, without great damage to one's chances of getting the job, that in no case can the results be rigorously foretold. Some reasonably accurate estimates may be made, especially in cases where there are echoes, but where it is chiefly a matter of correcting excessive reverberation, it will be best to remain discreetly silent about what the results will be.

Correcting Reverberation

There are only two conditions which may usually be corrected by acoustically treating a theater. These are "reverberation" and "echo." So-called interference patterns are corrected, generally by re-locating the horns. This difficulty is seldom met and will not be discussed here.

"Reverberation," or more properly,

THE subject of theater acoustics, or, more properly, treating adverse acoustic conditions, may seem to be far beyond the scope of the radio serviceman who is trying to gain a foothold in theater work. However, the previous articles have stressed the "learn by doing" idea and this holds true even in acoustics.

"reverberation time," is defined as the time required for a sound of specified intensity to die away to inaudibility. Reverberation time can be measured, but since the calculations indicated below are necessary in any case, it is just as well to apply them to the initial determination of the reverberation time. The Bureau of Standards (Circular 380) gives the following formula:

$$t = \frac{0.05 V}{A}$$

in which

- t = reverberation time, in seconds
- V = volume of room, in cubic feet
- A = "total absorption"

Figuring Absorption

The quantity A in the above equation is equal to the number of square feet of each of the different kinds of material in the room times the absorption coefficient for that particular material. Assume that a theater has ordinary plaster walls with a total area of, say,

2700 square feet. Tables of absorption coefficients give a value of 0.033 as the coefficient for plaster. This multiplied by 2700 gives 89.1 as the absorption of the walls. The floor, ceiling, stage opening, and seats are similarly calculated. The sum of all of these absorption units is A in the formula above. It is usually customary to calculate the absorption of the theater for half-audience and full audience, and, if the reverberation times for these two values of A are greater than the acceptable limits, acoustic treatment is needed.

Applying Formula

Sabine has given the following rough rule to determine the need for acoustic treatment: If the ratio of the volume of the theater in cubic feet to the average audience is greater than 150 then the room will in all probability be too reverberant.

Acceptable limits of reverberation time for various size rooms and for either half or full audience are given in Table Two. (Circular 380, Bureau of Standards).

Let us assume a theater having a volume of 180,000 cubic feet given by the following dimensions; length 120 feet, width 50 feet; and height 30 feet. The walls and ceiling are plaster, the floor, concrete, of which 30 per cent (aisles, etc.) is covered by carpet. It contains 800 seats, upholstered, seat and back, in hair and leather.

An Example

The area of the four walls equals 16,200 square feet. These surfaces, being of plaster, have an absorption of 0.033 per square foot, a total of 535 units.

Thirty percent, or (Turn to page 316)

TABLE 1: SOUND ABSORPTION COEFFICIENTS

CONCRETE	0.015
GLASS, SINGLE THICKNESS	0.03
MARBLE	0.01
OPEN WINDOW	1.0
PLASTER	0.033
STAGE OPENING (DEPENDING ON FURNISHING)	0.25-4
VENTILATORS (50 PER CENT OPEN SPACE)	0.50
WOOD, VARNISHED	0.03
AUDIENCE, PER PERSON	4.7
SEATS, UPHOLSTERED, DEPENDING ON MATERIAL AND LINING, PER SEAT	1.0-2.5
SEAT CUSHIONS, COTTON, COVERED WITH CORDUROY, PER SEAT	2.2
SEAT CUSHIONS, HAIR, COVERED WITH CANVAS AND LIGHT DAMASK, PER SEAT	2.3
SEATS, UPHOLSTERED IN HAIR AND LEATHER, SEAT AND BACK, PER SEAT	3.0
WOOD SEATS, FOR AUDITORIUMS, PER SEAT	0.1

TABLE 2
VOLUME OF ROOM (IN CUBIC FEET)

VOLUME OF ROOM (IN CUBIC FEET)	ACCEPTABLE LIMITS OF REVERBERATION TIME (SECONDS)	
	HALF AUDIENCE	FULL AUDIENCE
10,000	0.9 - 1.2	0.6 - 0.8
25,000	1.0 - 1.3	0.8 - 1.1
50,000	1.2 - 1.5	0.9 - 1.3
100,000	1.5 - 1.8	1.2 - 1.5
200,000	1.8 - 2.0	1.4 - 1.7
400,000	2.1 - 2.3	1.7 - 2.0
600,000	2.3 - 2.6	1.8 - 2.2
800,000	2.5 - 2.8	1.9 - 2.3
1,000,000	2.6 - 2.9	2.1 - 2.5

Here It Is At Last!

PUSH BUTTON Tuning

(The Midwest Model VT-20)

By Wm. C. Dorf

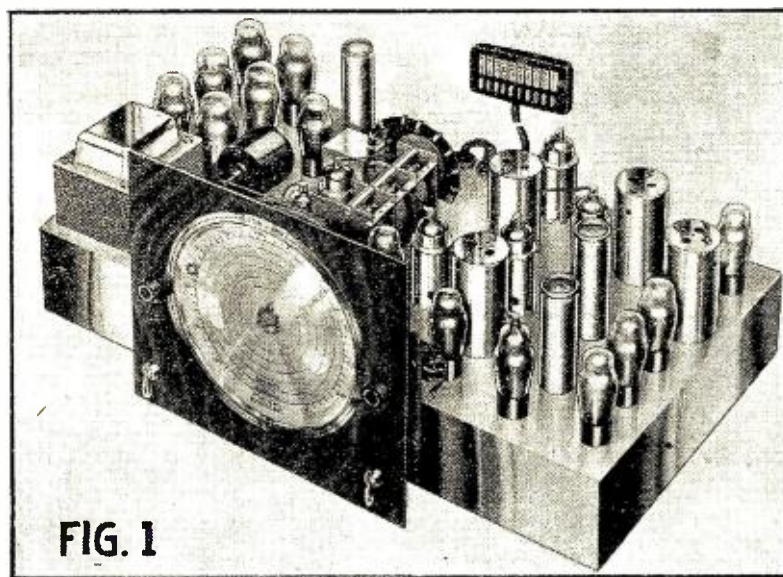

FIG. 1

A SET THAT TUNES AUTOMATICALLY

Without a doubt the most outstanding refinement in this new 20-tube receiver is Touch-Button Tuning. In this illustration the motor which does the actual work of the tuning is shown at the left and to the center rear is shown the commutator and contact brushes and also the ten-button panel. Of course, the receiver can be tuned by hand without resorting to the automatic device, especially when fishing for DX stations. The left-hand top knob is the manual tuning control.

THE introduction of "Motorized Push-Button Tuning" in the new 1938 Midwest 20-tube Deluxe receiver, represents a new era in simplicity of operation and ease of tuning. By simply pressing a button you can tune in any one of your nine favorite stations quickly, quietly and accurately. The push-buttons control a small motor which does the actual work of tuning, eliminating all thought and care on the part of the broadcast listener.

TUNING is truly automatic in this new receiver; no need to know the wavelength or frequency setting of the station. Touching a button, the motor goes into operation, speeds the dial and the attendant tuning-condenser assembly toward the station desired, and at the same time a colorful "bull's-eye" dial-light zips across the dial scale to locate itself behind the station selected.

With "Motorized Tuning" an electrical arrangement is provided for stopping the motor at the exact center of the station, thus, preventing "off-center tuning." Electrical tuning is remarkably fast. The manufacturer claims an average of $\frac{1}{3}$ of a second for tuning between stations, and RADIO NEWS tests indicated less than one second under the worst conditions.

The Midwest system is shown schematically in Figure 2.

In order to simplify the diagram only one push-button and contact finger is shown. The motor has one commutated rotating armature and two stationary fields. Rotation of the motor is either clockwise or anti-clockwise depending upon which field is used. As shown in the diagram power will be applied when the button is pressed, completing the circuit through the commutator and the anti-clockwise field in such a way as to cause anti-clockwise rotation of the variable condenser and its commutator. Rotation will continue until the insulated segment arrives under the contact finger.

Nine Contactors

There are nine contact fingers which can be set to nine stations so that when any one of the nine push-buttons is depressed the corresponding station is tuned in. The tenth or red button is used for turning the set off.

Figure 3 shows the rear view of the commutator and contact brushes or fingers mounted on the rear of the variable tuning condenser. The shaft of the

condenser extends out through the contact finger assembly and connects to the commutator. The segments of the commutator are not shown, the line of separation runs diametrically through the shaft from the arrow and "heart." Note that these contact fingers can be freely moved around their holding ring. To adjust the set to a desired list of stations is, therefore, a simple matter and it is equally easy to change to a second or even a third choice of stations.

Speedy System

The motor is of the series type and is capable of exerting a force of 10 inch-ounces with armature blocked. This high starting torque is to insure speedy operation of the entire system.

No attempt is made to stop on the station without overshooting. The high-speed and inertia of the system necessitates overshooting. It will be noted that when this condition occurs, reverse voltage is applied automatically. The high starting torque of the motor causes it to immediately (Turn to page 317)

ELECTRIC MOTOR CONTROL

This is a close-up view of the commutator and contact brushes mounted on the rear of the tuning condenser. This device interprets the push-button orders and transmits them to the electric motor.

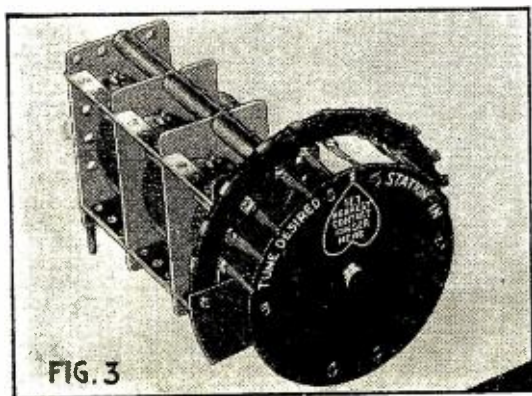

FIG. 3

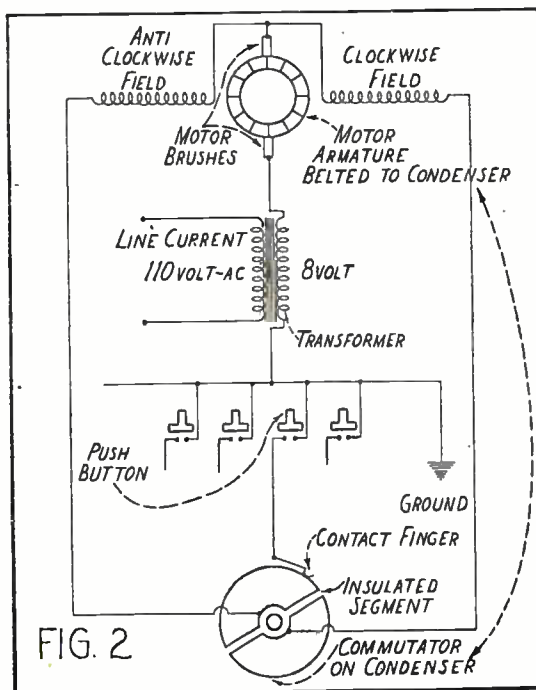

FIG. 2

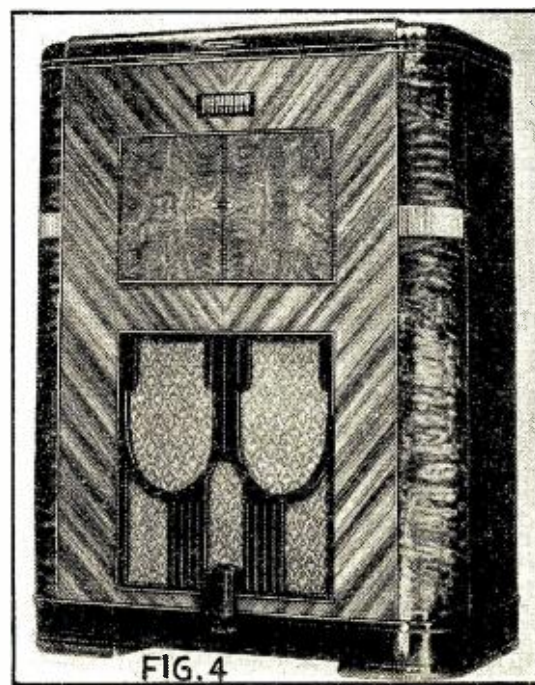
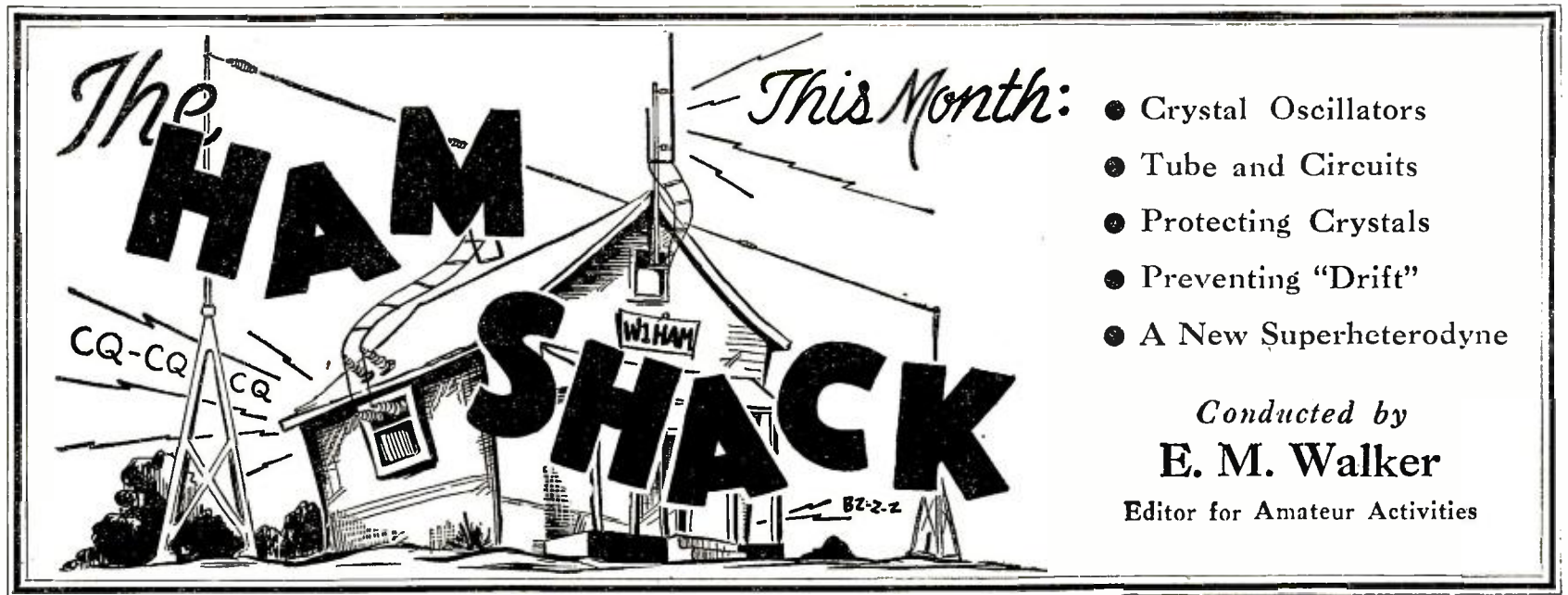

FIG. 4



Conducted by
E. M. Walker
 Editor for Amateur Activities

Choosing A CRYSTAL Oscillator

RELIABLE operation of an amateur transmitter, either 'phone or c.w., is dependent to a large degree on the stability of the signal put on the air. Without such stability a station emits an unstable signal and, in addition to violating regulations, is causing serious disturbance on already crowded bands. The most serious QRM is caused by them. One station in this category can cause more QRM than ten or twelve normally operated stations.

GREAT care should be taken in the selection of the type of oscillator used in an amateur transmitter and its construction. Both these factors are important. The type selected should be one that meets the driving requirements of the tube following it in the transmitter. At the same time the design, arrangement of the components and operation of the unit should be considered with the sole view of obtaining an output that is adequate; that is without appreciable drift; that does not endanger the crystal and one that is not affected by climatic and other conditions in the transmitting room.

Using Various Types of Oscillator Tubes

The principle of all crystal oscillators is the same. Three types of tubes are used for them, thus permitting their classification as, triode-tube oscillators, pentode-tube oscillators and power-tube oscillators. The choice of type will depend on the power output requirement; the frequency on which it is to be used; and whether or not

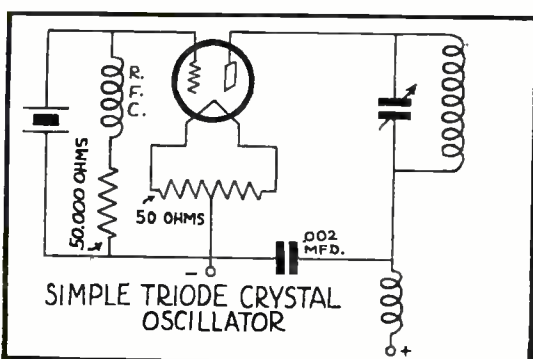

it is to be used as an oscillator-doubler, quadrupler or just a straight oscillator.

The most commonly used tubes in crystal oscillators are receiving type pentodes and tetrodes, designed for audio amplification work. Tubes in this category are the 47, 41, 42, 6L6, 59 and 2A5. All of these tubes are excellent oscillators and will deliver more than 10 watts of power. Higher outputs are obtainable from such tubes than from triodes because of the screen which accelerates the electron flow to the plate, and permits the use of higher plate voltages without endangering the crystal. Plate voltages as high as 500 volts may be used on tubes of this type. In general, the screen voltage should be about 100 volts and is obtained through a dropping resistor.

Triode Oscillators

Triode oscillators by-and-large, are the simplest to construct, and when operated conservatively will provide a stable output, but usually have a low harmonic output and therefore must be followed by an amplifier whose grid circuit operates at the oscillator frequency. Plate voltages higher than about 250 volts cannot be used. Higher plate voltages will increase the crystal current to a point where the quartz cannot stand up under the strain and, consequently will crack. The danger of cracking a crystal is increased at higher frequencies. But there are a number of advantages in using triodes as oscillators. One of the most popular types of crystal oscillators used a type 53 or 6A6 (a twin triode) as oscillator and oscillator doubler. Within the last year, the 6C5, a metal tube, has become popular as an oscillator tube used in conjunction with tubes of low-power driving requirements such as the 6L6, 807, RK39 and 802.

Transmitting pentodes are the latest addition to the family of oscillator tubes. Their use facilitates obtaining a high order of output from a crystal oscillator, but most of the tubes in this category will give a higher output in proportion to input if a smaller oscillator tube is used to excite the grids of these pentodes. The tubes in this group are the 802, the 807, RK23, RK25, RK20, RK28, and 804. The first four tubes are in the lower power class and therefore may be used as crystal oscillators with greater efficiency than tubes of receiving types. The latter tubes are real power tubes and will provide high outputs when used as the only tube in a transmitter, but are not recommended as crystal oscillators driving high-power stages in 'phone transmitters. However, they are all right in c.w. transmitters.

Regardless of what type of tube is used in the crystal oscillator, good design has as much to do with the stability of the unit as the grade of the components employed. Modern practice calls for mounting the parts on a metal chassis and the use of the shortest possible leads. In any case a high-capacity tank condenser (between 50 and 100 mmfds.) should be used. While this may tend to lower the output it will greatly add to the stability which is far more important in a crystal oscillator than output.

Tube heating is one of the greatest causes

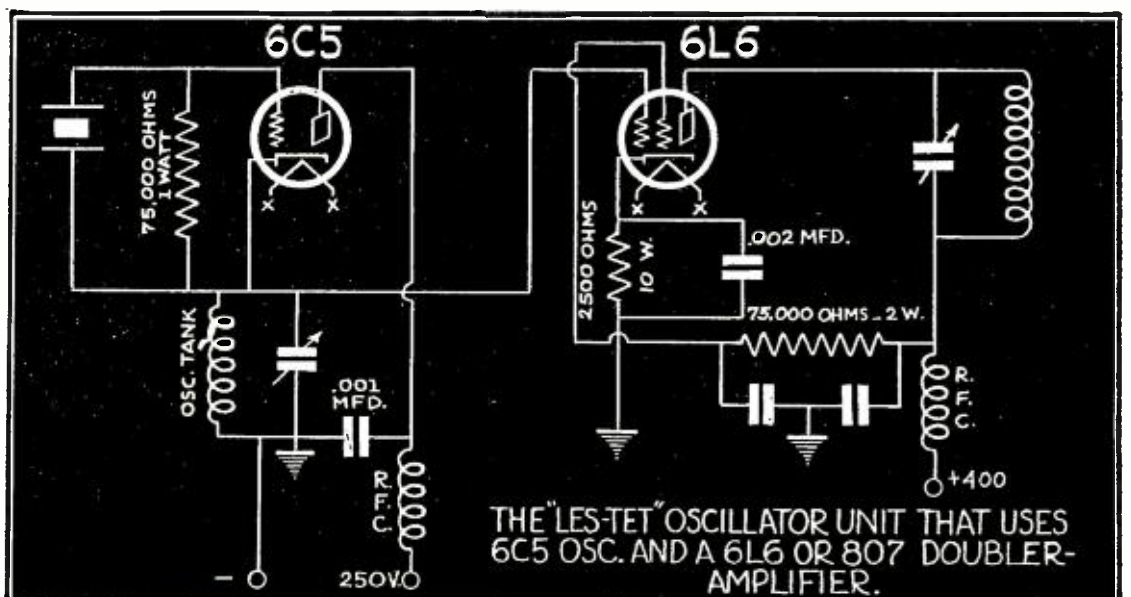
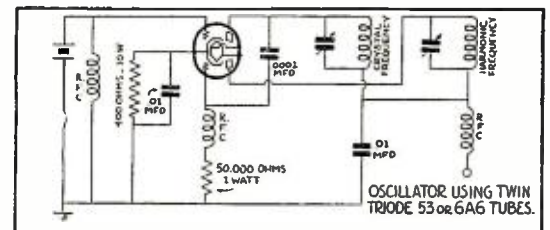

Q A Department for the amateur operator to help him keep up-to-date

of drifting in crystal oscillators, therefore, regardless of the type tube used, it should be operated as conservatively as possible. It often is desirable to use an additional lower-powered amplifier in the transmitter in order that the oscillator may be operated at a conservative voltage. A few degrees change in temperature of the crystal will result in several kilocycle drifts with X and Y cut types.

47's, 41's, 2A5's

For low-frequency operation (i.e. 75 and 160 meters) tubes of the 47, 41 and 2A5 are excellent oscillators. When tubes in this category are used with 400 volts or less on the plates, they are extremely stable and will deliver more than sufficient output to drive a medium-powered triode such as a 210 or tube of similar power requirements. However, these tubes are not particularly rich in harmonic output and therefore the tube following should be operated at the crystal frequency.

The "Tri-tet"

If a high harmonic output is desired it is advisable to use tubes capable of operation in "tri-tet" circuits such as the 802, 807, 6L6, RK23, RK25, 80 and 59. The "tri-tet" principle uses the oscillator tube as a frequency multiplier by operating the grid at the crystal frequency and the plate at double the crystal frequency. Also it may be used as a quadrupler but unless extreme care is used in adjusting the circuit it is apt to put a strain on the crystal. Only a few of these tubes are suitable as quadruplers, notably the beam-power tubes such as the 6L6, 807 and RK39.

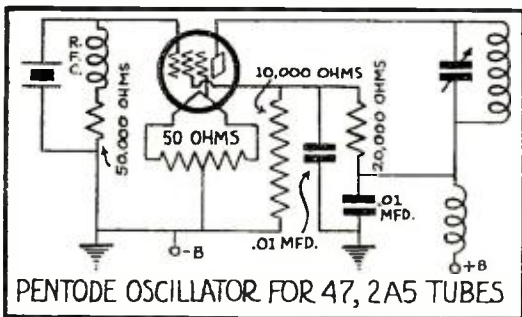

New Super Has
FULL VISION
Tuning Dial
By Robert Ames



A LINEAR DIAL

The new NC80X and NC81X receivers differ only in frequency coverage, the latter receiver being especially for the Ham bands.

A NUMBER of new receivers have been introduced this year of particular interest to both the amateur and short-wave listener. Several of these have been in the medium priced class. The latest one to make an appearance in this category is the NC80X and NC81X, announced by the National Company, Inc., of Malden, Mass.

The NC80X is designed for continuous band coverage including regular broadcasting while the NC81X is designed especially for amateur use and covers all of the amateur bands, but does not take in regular broadcasting. Otherwise both receivers are identical.

Both receivers use ten tubes in a super-heterodyne circuit. They include a 6L7 as first detector; 6J7 as high-frequency oscillator; three 6K7s as intermediate amplifiers; one 6C5 as second detector; one 6B8 as in the amplified and delayed, automatic volume-control circuit; one 6J7 as beat-frequency oscillator; one 25L6G as beam-power output amplifier and a 25Z5 rectifier.

The receiver is mounted in a black

crackle finished cabinet with all of the controls conveniently placed on the front panel. The tuning system is interesting in that it employs a large multiple-scale dial of the full-vision type that is calibrated in megacycles.

An unusual feature of the dial is the incorporation of a mirror for overcoming parallax. Another feature is the use of an auxiliary linear scale (at the bottom). Also an adjustable frequency marker by means of which any station or frequency may be logged is incorporated on the dial. The dial is equipped with two vernier reduction ratios, viz., 16 and 80 to one with a separate knob for each.

1560 kc. Intermediates

One of the most unusual features of the receiver is the use of 1560 kilocycle intermediate-frequency transformers. This high i.f. frequency offers many interesting possibilities, among which is a high order of image suppression. Tests made in the manufacturer's laboratory showed this design resulted in better image suppression than obtainable in many receivers having elaborate preselectors.

Both models of the receiver are equipped with crystal-filter circuits. These are connected in the second i.f. stage and provide continuously variable selectivity from 400 cycles for c.w. reception to 5,000 cycles for high quality broadcast. The circuit is designed to extend the range of the phasing circuit for heterodyne elimination. Because of this variable characteristic, the crystal filter is kept in the circuit at all times.

Band changing is accomplished by means of plug-in coils controlled by one knob on the front panel. On the NC80X, the frequency coverage is continuous from 550 kc. to 30 mc., except for a small gap at the i.f. frequency of 1560. This is covered in four ranges. The NC81X is designed as a special amateur model and covers only the amateur bands, viz: 1.7 to 2 mc., 3.5 to 4 mc., 7 to 7.3 mc., 14 to 14.4 mc and 28 to 30 mc.

Ten controls are mounted on the front panel. They are: oscillator on-off switch; oscillator pitch control; I.F. gain; combined on-off and stand-by switch; A.V.C. on-off switch; band changing switch; tuning controls, crystal phasing control and audio gain control.

W4EDD, CORAL GABLES, FLA.

At left: The operating room of H. H. Robinson's extraordinarily complete Amateur Radio Station, W4EDD. At the left are the transmitters and at the right, the operating table with its three receivers and speaker systems including a complete control panel. Everybody in the world knows the fine signal put out by W4EDD and welcomes "Robbie's" cheery voice.

The New
“Skyrider”
 11-TUBE
 Receiver

By Laurence M. Cockaday
 and S. Gordon Taylor

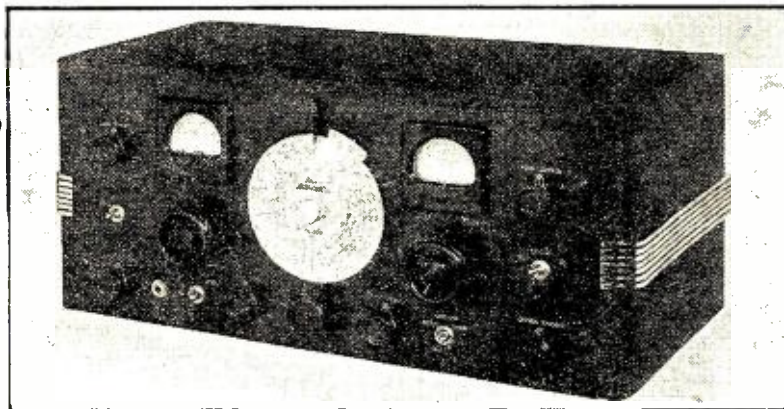

AN EXCELLENT ALL-PURPOSE RECEIVER
The manufacturer has here incorporated in one receiver, all of the features necessary to meet the requirements of the “Ham”, the Short-Wave Listener, the DX’er, and the lover of good musical reproduction on the broadcast band.

THE 1938 Super-Skyrider Model SX-16 receiver is one which will unquestionably be of interest to many readers of RADIO NEWS because it includes not only all of the features essential in communication and short-wave reception but also many refinements which provide an extra measure of utility, flexibility and ease of control. One of these receivers is now under test at RADIO NEWS short-wave Listening Posts and amateur stations. Next month the results of these tests will be presented, therefore the present article will be descriptive.

FROM the standpoint of appearance the new receiver sets a fine example. Heretofore, most communication receivers have presented a most austere if not funereal appearance which has been quite appropriate when used in the radio shack of a battleship or other such locations, but for the home of a Short-Wave Listener or for an Amateur, an external design somewhat less severe, yet not ornate, is far more appropriate. This happy medium has been achieved in the new Skyrider.

The circuit employs eleven tubes as follows: A 6K7 r.f. amplifier stage, 6L7 mixer, 6G5 oscillator, two 6K7’s as i.f. amplifiers, 6R7 second detector—a.v.c.—first audio, two 6V6’s in the push-pull, 13 watt audio output stage, 6J7 beat-frequency oscillator. 6J7 “S” meter amplifier and a 5Z3 rectifier. The complete schematic circuit is shown here-with.

Three input connections are provided, providing for the use of either a doublet antenna, or an L antenna with ground. Output connections are provided for both 5000 ohms or 500 ohms, both

clearly marked. Neither of these output circuits carries any direct current. A pair of terminals is also provided on the rear of the cabinet to permit the use of a remote standby switch or relay as, for instance, where it is desired to control a transmitter and the receiver from one switch.

The loudspeaker provided with the receiver is one of the permanent-magnet type capable of fine quality of reproduction and of handling up to 18 watts output. The idea of using a permanent magnet speaker is a commendable one because it makes the speaker and receiver entirely independent of one another which is not the case where field coil of a dynamic speaker is employed as part of the filter system in a receiver. This means that the owner of the Skyrider can use any other speaker he desires with this receiver, provided it has the necessary power handling ability, and therefore allows much more leeway in the choice of speakers.

The tuning range of the receiver extends continuously from 540 kilocycles to 62 megacycles and therefore includes everything from (Turn to page 314)

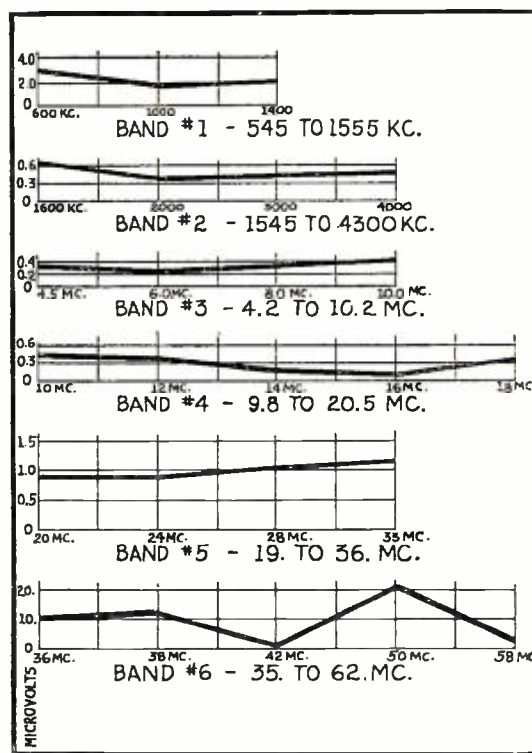

USABLE SENSITIVITY
 Figure 1—Values shown represent signal input (80 percent, 400-cycle modulation) required to equal noise input with unmodulated carrier.

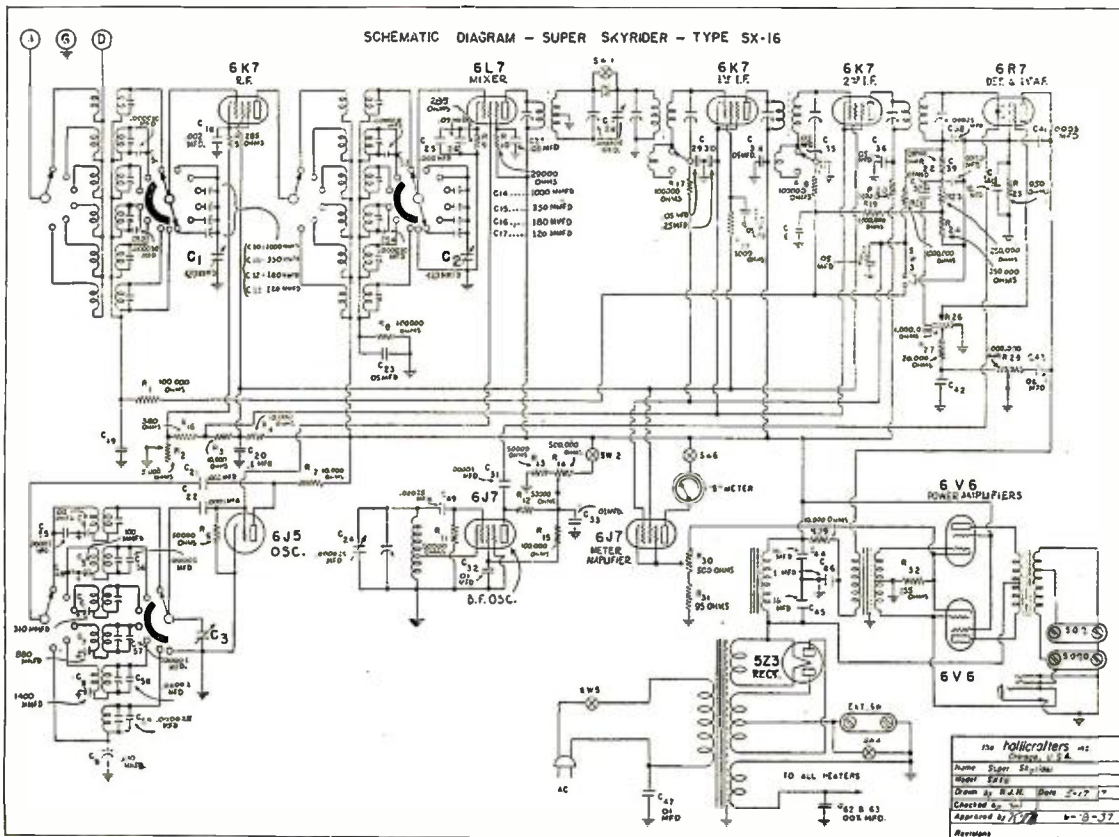
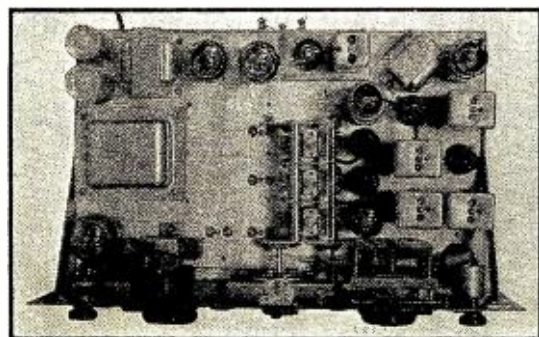

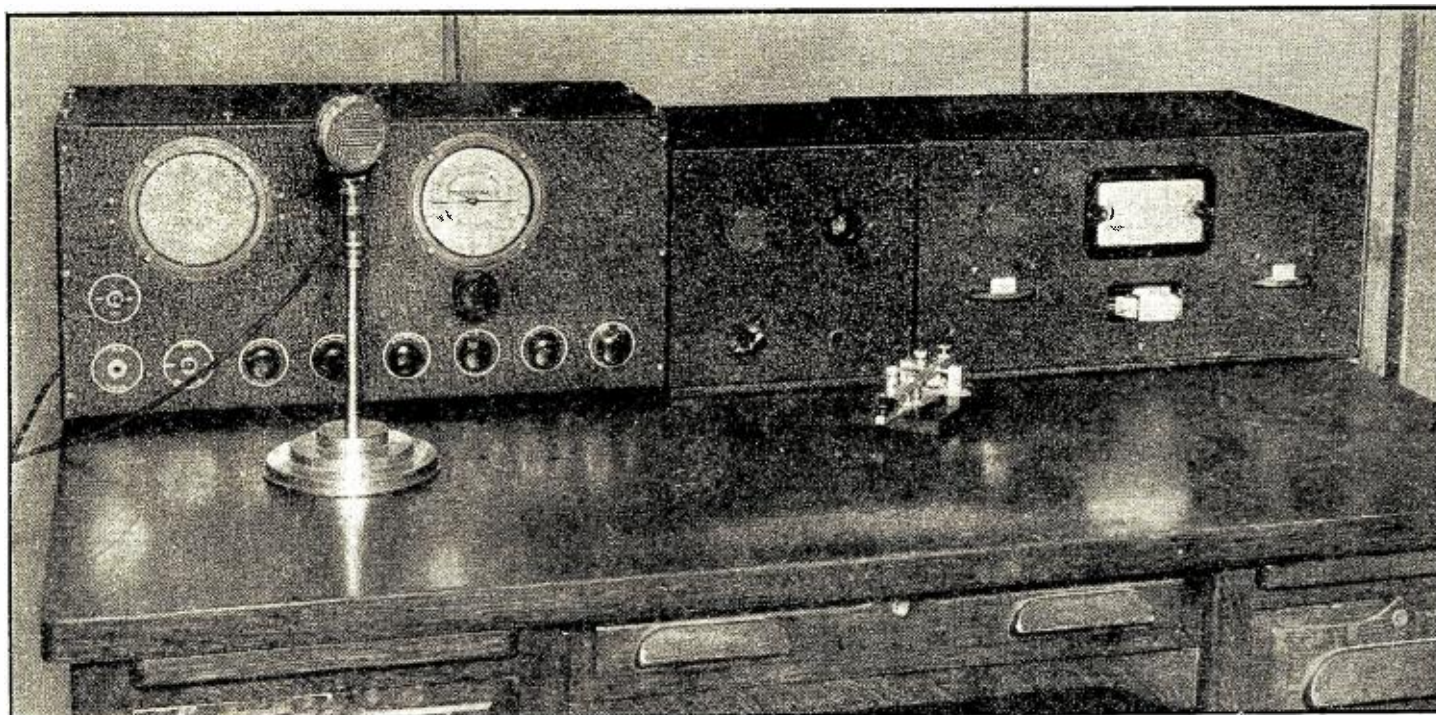

THE TRANSMITTER SET UP FOR TEST AT AMATEUR STATION W2MW

Here is one corner of the "shack" of W2MW where the tests were conducted. The OR-5 transmitter is at the right, with the OR-7 modulator in the center. The receiver, at the left, is also a Montgomery Ward communications model. The modulator circuit is shown below in Figure 4.

Testing A 10-160 Meter Transmitter for Amateur Use (Montgomery Ward Model OR-5)

By Everett M. Walker
(W2MW)

(Part Two)

BEFORE we start telling of the results of air-testing this Type OR-5 transmitter, a few notes on operating will be of interest. Grid biasing for the amplifier is obtained by a combination of grid leak resistor and a 45-volt battery, connected externally. The use of the battery causes the plate current on the RK-20 to drop to a safe value when excitation is removed, thus permitting oscillator keying and providing protection against overloading the tube. An alternate method of keying is provided by the provision of two terminals in the center-tap of the RK-20 filament winding.

Voltage for the suppressor grid is obtained from an external 45-volt battery (separate from that used in the grid circuit). The positive side of this battery is connected to the suppressor when the transmitter is used for c.w. operation. When used as a suppressor grid unit, the suppressor voltage is connected so that it is negative with respect to ground. Thus when a modulation voltage is introduced in this circuit it causes it to swing toward the positive, resulting in increased linear modulation up to 100 percent.

Separate antenna pick-up coils are provided on each plate coil. Once the out-

TESTS made at W2MW with this transmitter showed that it would deliver more than 60 watts when used for c.w. on all bands excepting 10 meters. On this band the output is approximately 40 watts.

put coils are adjusted for the particular antenna used with the transmitter, no further adjustment is necessary when changing bands. Satisfactory coupling may be obtained into resistive loads varying from low resistance Marconi or doublet antennas to higher resistance loads presented by matched-impedance single-wire and two-wire fed antennas. If the type of antenna used requires tuning of the feeders, such a unit may be connected externally. It is preferable to use some form of impedance-matching network such as the pi-section unit because the coupling coil is closely coupled to the tank circuit.

Montgomery Ward offers a separate external modulator unit for suppressor grid modulation for use with the OR-5 transmitter. It is shown next to the transmitter in the photograph above and is 10 5/8 inches deep, 9 3/4 inches wide and 9 inches high. The modulator unit is designed to provide suppressor modulation of the RK-20, and provides economical telephone operation at a power output of 15 to 20 watts of carrier. The amplifier contains its own power supply and uses metal tubes, namely: one 6J7, one 6C5, one 6F6 and one 5Z4.

The suppressor grid requires a (Turn to page 315)

THE MODULATOR CIRCUIT

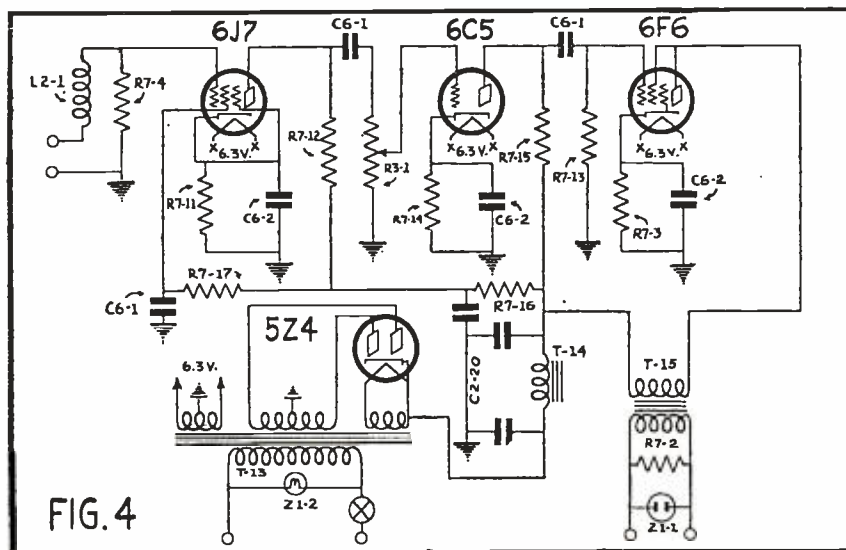

W2JCR's Practical "TINY" A Portable

The installation described here provides operating convenience yet, in keeping with mobile accessory installation, does

By S. Gordon

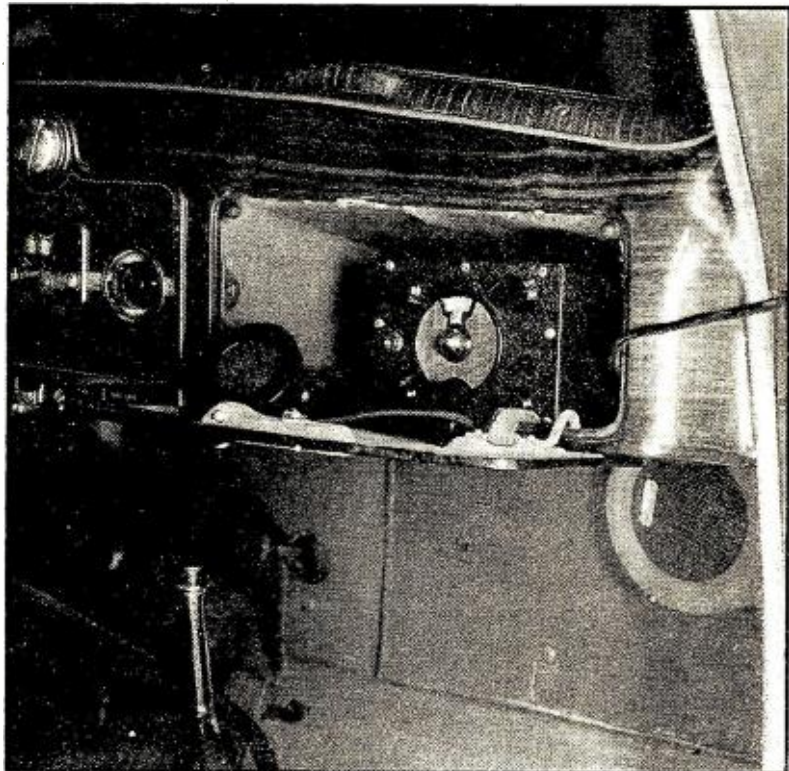

THE OPERATING POSITION

The glove compartment on the dash provides ample room for the "Tiny Tot" receiver, the microphone, log book, etc., all of which are concealed when the door is closed. The speaker is shown just below.

THE "Tiny Tot" portable-mobile, 5-meter receiver and transmitter as described in the September and October issues have been installed in the author's 1937 Plymouth Sedan and it is the purpose of the present article to provide information on this installation in the hope that it may be of some assistance to others who contemplate portable-mobile installations.

IN planning the installation, there were two requirements which were considered highly desirable if not essential. The first was that inasmuch as the car is used primarily for transportation purposes and not as a mobile radio laboratory, any equipment which would clutter up the seats, or reduce leg room, was taboo. On the other hand, it was considered imperative that the equipment be completely controlled and operated from the front seat. Further, what was wanted was an installation which would provide a signal comparable with the "better than average" 5-meter home rig. Inasmuch as the receiver and transmitter described in the past two issues were designed to meet these requirements—in fact, were designed by Art Haynes, W2JHV, for this particular installation, they constitute the equipment employed.

Briefly, the installation consists of the

hand-microphone which plugs into the glove compartment and one of the new Wright-DeCoster "Nokoil" dynamic speakers installed on the bulkhead under the dashboard. A door-hinge antenna of the telescoping type is mounted on the door nearest the receiver while a half-wave telescoping antenna projects through the top of the trunk so that its lower end is connected direct to the antenna terminal of the transmitter.

Front Seat Control

The whole rig is turned on and off and completely controlled from the front seat. The only time that the trunk need be opened is in tuning up the transmitter. For this purpose provision is made for plugging the microphone and the milliammeter directly into the transmitter circuits within the trunk.

The installation is shown graphically in Figure 1. The inter-connecting wires actually terminate in cable plugs, at each end as shown in the "Tiny Tot" constructional article, but for convenience and clarity, Figure 1 does not show this. These wires are not cabled for the simple reason that they are run under the carpet and lie flatter if they are not bundled together.

The Wiring

The two B plus leads from the transmitter to the receiver consist of two lengths of ordinary shielded antenna wire. A twisted pair would probably have served the purpose just as well but the copper braid covering over the rubber insulation provides somewhat better mechanical protection. The shields of the two leads are bonded together and grounded at one or two points on the frame of the car and also to the grounded side of the car battery circuit at the transmitter plug. All wiring from the car battery to both the receiver and the transmitter employs heavy stranded wire equivalent to about No. 10 and with heavy rubber insulation. These leads are run along the floor in such a manner as to provide the shortest possible length. It so happens that the receiver and transmitter are in diagonally opposite corners of the car. Wiring, therefore, passes very close to the bat-

PORTABLE MOBILE DELUXE

Here is the rig with antennas extended as in actual operation except that this photo cuts off the tip of the transmitting antenna.

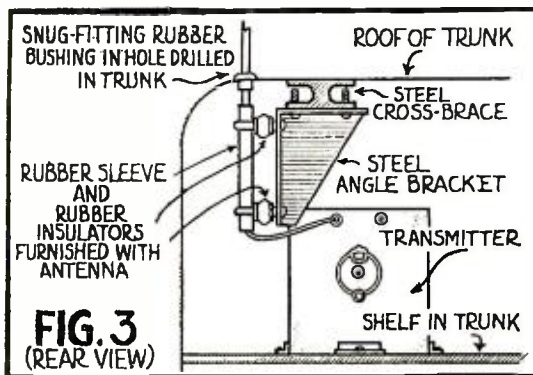

Installation of the TOT

Mobile Rig

vides excellent results and maximum
ing with the modern trend in auto-
not encumber passenger space.

Taylor (W2JCR)

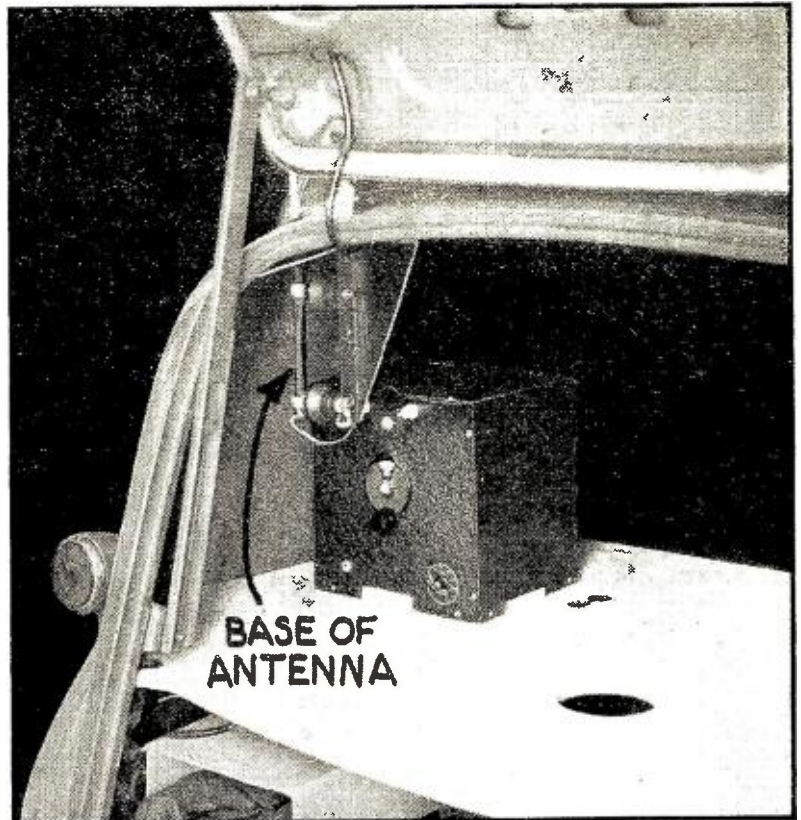

THE TRANSMITTER

This unit is installed in an out-of-the-way corner of the trunk. The method of mounting and insulating the antenna is clearly shown.

tery container. The main switch which controls the entire installation is mounted on the front seat, down near the floor where it is within a few inches of the battery compartment. The main fuse (20 amperes) is one of the kind having a cartridge type holder inserted directly in the lead to the battery. This is convenient inasmuch as no fixed mounting is required.

Fuse Protection

It might be mentioned here that all of the precautions indicated in the battery circuits are strongly recommended. If a suitably large conductor is not available, two lengths of No. 14 or 16 may be connected in parallel for each battery lead to provide the necessary low resistance. By all means do not overlook the fuse. There should likewise be a 15 ampere fuse in the transmitter. This also is in the "hot" battery lead. Through an oversight, this fuse was not shown in the circuit in the October issue but was shown in the photographs of the chassis.

The microphone circuit employs a 1½-volt dry cell as a microphone battery rather than the internal supply provided in the "Tiny Tot" receiver. This change was made to completely eliminate noise and hash which proved to be present on the carrier with the original arrangement.

Figure 2 shows the slight change made in the transmitter. The original jack was rewired as a single circuit open jack. One side of it was then grounded instead of connecting to the "mike" lead in the cable. The lead from the other side to the microphone transformer was broken and two short lengths of wire were brought out from this point to a 1½-volt dry cell installed in the trunk next to the transmitter. A by-pass condenser may be connected across the inner end of these two leads to avoid r.f. feed-back, although if the leads are twisted, this condenser will probably not be needed.

Noise-free Circuit

No change is required in the receiver although, of course, the microphone supply circuit consisting of the 600-ohm resistor R11 and the by-pass condenser C11 are not used. A microphone jack was installed in the glove compartment beside the receiver. From here an ordinary twisted pair was extended back to the trunk and there terminates in a phone plug which is in turn plugged into the microphone jack of the transmitter and is left that way permanently except at such times as it is desired to

plug the microphone itself directly into the transmitter in testing or tuning up.

The Stromberg-Carlson No. 6 hand microphone was selected because it provides an unusual combination of high output and excellent speech quality. Moreover, it operates to maximum advantage with only a 1½-volt supply and the current drain is in the neighborhood of 10 milliamperes. In view of this latter condition, it would be entirely practical to use a flashlight cell for the microphone supply and mount it inside of the transmitter. The author employs a standard 1½-volt cell simply because there was plenty of room available for it in the trunk and because with such a supply the battery life may be measured almost in terms of years. No switches are provided for this battery but instead the circuit is broken by pulling out the microphone plug when the station is not in operation. Even if this were forgotten, it would require months of continuous operation to run this battery down at this current drain.

Antenna System

The speaker selected is a Wright-DeCoster 5-inch "Nokoil" enclosed in a type TEC1000 cabinet of the same make. This may be seen in the inside photograph. This whole assembly is extremely compact and is both (*Turn to page 295*)

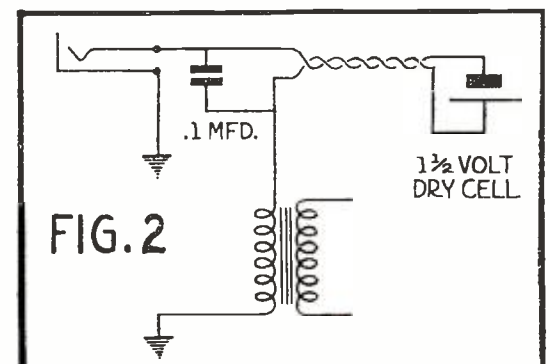
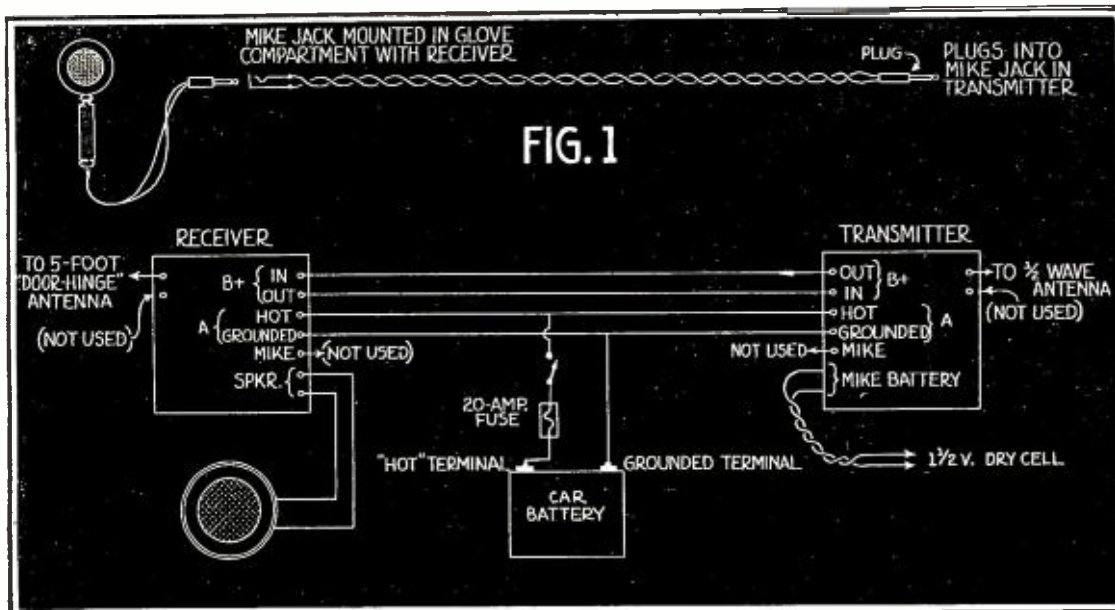

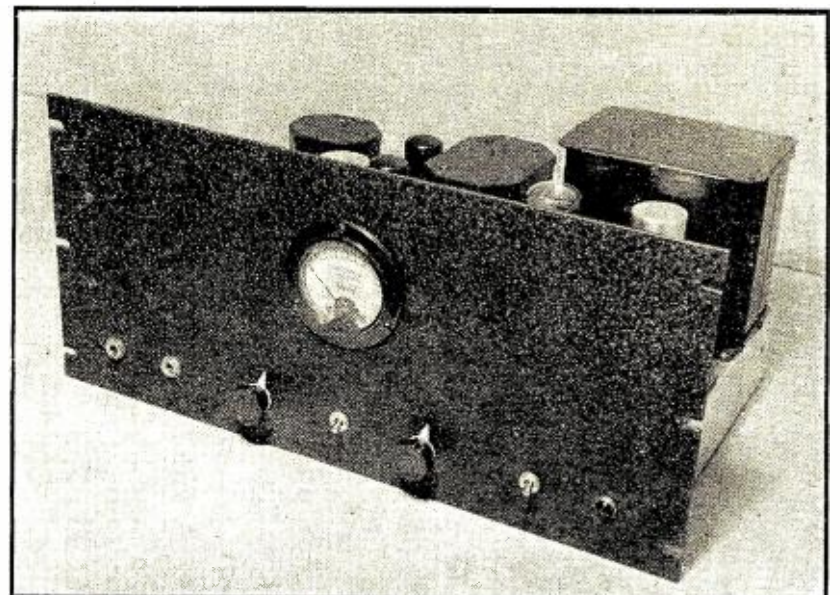

ABOVE AT LEFT: REAR VIEW OF UNIT N. AT RIGHT: FRONT VIEW SHOWING DECIBEL METER

Design and Construction Data on a Modern X'tal-Control Transmitter

(The Master-Control Unit)

By Willard Bohlen
Chester Watzel
L. M. Cockaday

(Part Four)

THE lower section of the dual operating control cabinet holds the versatile Unit N. As was briefly explained in the first article, this unit takes care of four separate and distinct functions. They are (A) speech amplification, (B) simplified audio mixing, (C) volume-level indication and (D) master control of the entire transmitter. We will now take up in detail the design and construction of unit N in the above order.

Figure 4 is a complete diagram of Unit N. The speech amplifier, (A), consists of but three stages. The simplification of the speech section to this number of stages is made possible by the use of high-gain tubes throughout.

The speech amplifier section, as described and used originally, was somewhat different than now. As originally designed four stages were employed instead of the present three. A 6N7 (dual metal triode) was used for both the first and second stages. The second stage was transformer coupled to another 6N7, used this time as a push-pull stage. This push-pull 6N7 stage was then transformer coupled to a pair of 6L6's. The latter tubes run in class AB1 to provide 30 watts driving power for the Taylor 822 modulator tubes.

The other change between the original speech amplifier and the present one was in transformer T20. This was, originally, a type PA-52AX. This particular transformer is shown in the rear view photograph of the unit,

IN the first article on this transmitter appearing in the August issue of RADIO NEWS are shown both a photograph of the complete installation at W2JCY and a block diagram (Figure 1). At the extreme left of both the photograph and the diagram are illustrated a double-deck Parmetal cabinet. The upper section of the cabinet contains a standard National HRO receiver, equipped with rack-type panel. No changes were made in this receiver, the regular National panel being of standard 19 by 8 3/4-inch dimensions.

no new photograph being taken since this transformer was replaced by the present one. The reason for using the unreasonably large PA-52AX was to take, directly, the output of a 5-meter receiver for mixing. As the 5-meter receiver had no output transformer T20 was required to have a primary winding capable of taking the full plate current of the pentode-output power tube of the 5-meter receiver.

When the original amplifier was first tested two difficulties showed up. One was too much gain. This showed up as a tendency for feed-back when the entire transmitter was running. The first 6N7 was then hooked up with the two sections of the tube in parallel, instead of in cascade. With the latter connection it was found that there was still ample gain to spare when a standard crystal microphone was used, while the tendency toward feed-back has disappeared entirely. The amplifier was, therefore, left this way. It is always

good practice in amplifier design to keep the number of stages to a minimum.

It was found that the construction of the PA-52AX transformer (T20) was unsuited for low-level work. In the position shown in the photograph it picked up too much of the hum field of the power supply. A type PA-136 was then tried in this position. This type of transformer is made in the new "hum-bucking" type of construction, greatly minimizing hum pick-up from adjacent hum fields. The

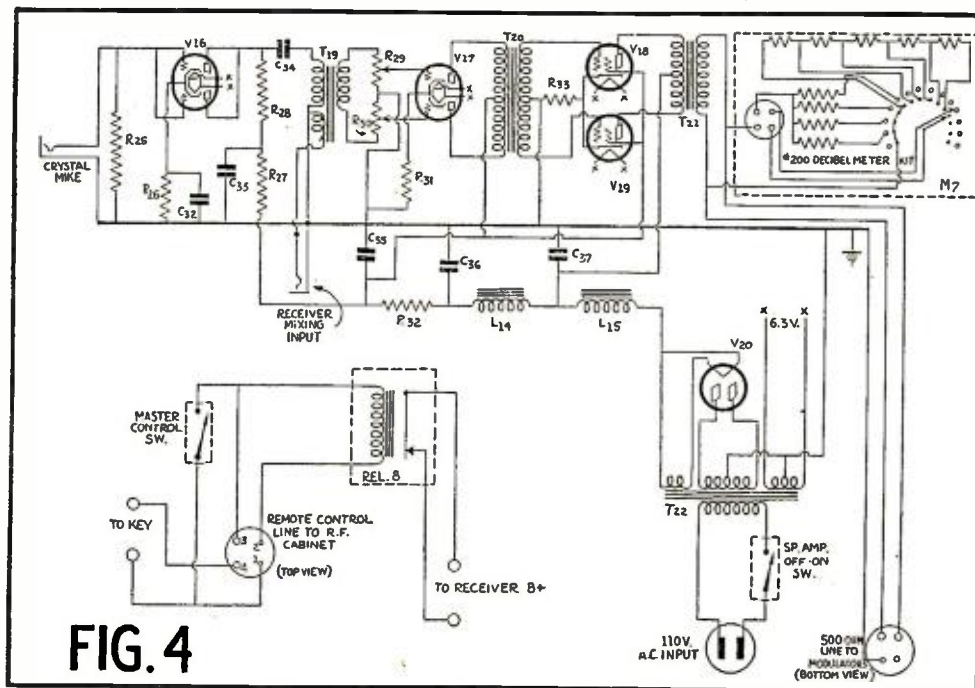
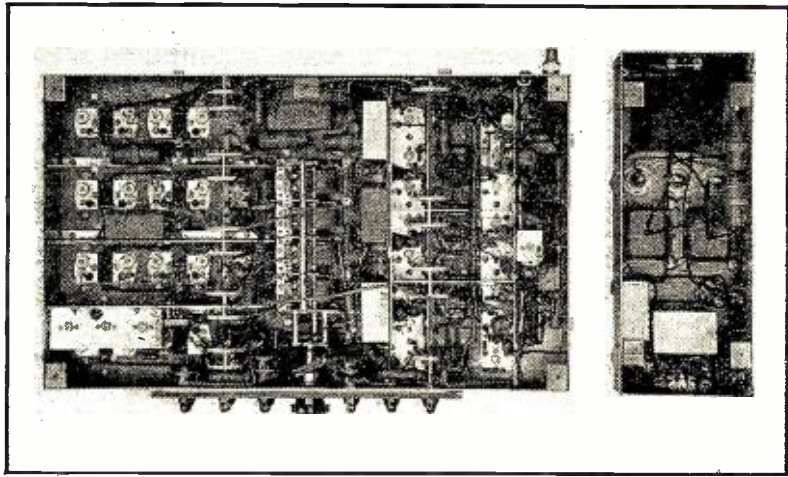

FIG. 4



UNDER THE CHASSIS

The carefully designed and shielded compartments show up well in this illustration of the main chassis and the power chassis (at the right).

Design Features of the New "Masterpiece" 21-TUBE Receiver

(Silver Masterpiece VI)

By McMurdo Silver

(Part Two)

IN the preceding issue the new all-wave Masterpiece VI was illustrated and a few of the new engineering developments incorporated in it were "high-spotted." Herewith are presented its most interesting circuit, together with an illustration of its unusually neat and orderly "engine room."

THE construction details of this new receiver are certainly worthy of careful study, for it is in this rugged and electrical symmetrical layout that its fine performance is insured. This point of what may be termed "battleship" construction is one usually slighted in ordinary broadcast receivers, yet it is one of vital importance. There is no point in designing a fine radio receiver and then cheapening its mechanical construction so that it is so fragile as to be

unable to maintain its performance throughout the handling and strains to which it is bound to be subjected during shipment and use. The chassis, for but one example, of the average radio, is formed of steel $\frac{1}{8}$ inch thick. Its side and end flanges are bent down and possibly spot welded brackets are located at one point on each folded seam in an attempt to obtain rigidity. How inadequate this is, is easily proven by the ease with which, when held in the hands, such a chassis may be warped. Such an unsubstantial assembly cannot assure original and unvarying performance, particularly when such a chassis is seldom provided with internal bracing in the form of shield partitions to adequately stiffen it.

As each Masterpiece VI is in-

dividually custom-built to the specifications of its prospective owner, it must be so built as to insure the permanent maintenance of these initial characteristics throughout a probable 10 to 20-year life, else there would be no point incorporating an advanced electrical design. So it starts with a steel chassis almost $\frac{3}{8}$ inch thick, the flanges of which have their entire seams completely arc-welded. Thus the chassis becomes a heavy pan of arc-welded steel, so rigid it cannot be warped, bent, or twisted—a foundation rugged enough to prevent any upset to the many precisely adjusted circuits it carries. It is further braced laterally and horizontally by shield partitions which bisect its length and breadth. These partitions are (Turn to page 310)

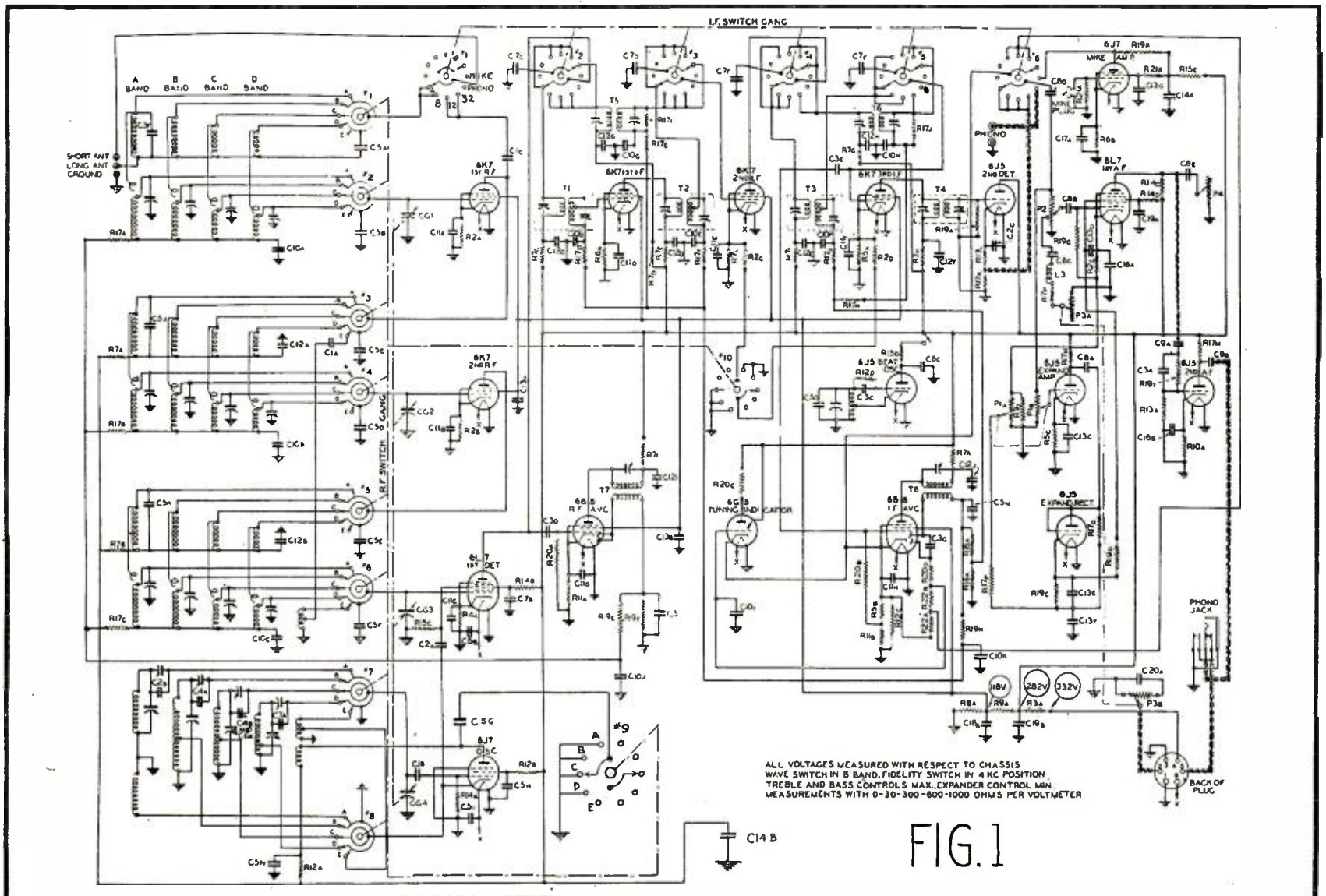

FIG. 1



PROGRESSIVE L.P.O. FOR CUBA
Augusto Anca, above, sends greetings to other fellow Observers of RADIO NEWS, a copy of which he keeps at hand when DX'ing. He uses a Silver "Masterpiece" receiver.

THE Fifty-sixth installment of the DX Corner for Short-Wave contains the World Short-Wave Time-Table for 24-hour use all over the world and Official Observers' reports of stations heard this month. Consult these two items regularly and make your allwave set pay big dividends!

Credit Where It Is Due

We are glad to be able to "star" the following Observers for their excellent reports for the past month: Alfred, Shea, Shamleffer, Partner, Hedgeland, Diez, McCartin, Hartzell, Pena and Fleming. Our heartiest commendations to this increasing number of observers who have done most exceptional work.

News Notes

S. W. Listener, J. I. Vaught of New Orleans, La., would like to swap SWL cards with other SWL'S, amateurs, etc., in the United States as well as outside. Observer Lionel White of Elmhurst, L. I., wishes to correspond with other observers in the U. S. and other countries. In a note from Observer H. J. Potthoff of New York, he states that all QSL'S from readers of RADIO NEWS may be sent to "Rueda del Oeste," Paseo Colon 470, Buenos Aires, Argentina. This association guarantees to deliver the cards to the stations gratis. Observer P. Piorko of Lodz, Poland and Listener George A. Krause of Flushing, N. Y., both signify their desire to correspond with other short-wave DX'ers anywhere in the world. Letters to any of these readers may be sent to RADIO NEWS and they will be forwarded to the correct address.

Charles N. Eggenweiler of Los Angeles, Calif., notifies us that a photograph of his Listening Post appearing on page 672 of the May issue was captioned as that of Mr. H. E. Howard of Beverly Hills, Calif., a case of mixed captions which, we are glad to state, is a rare occurrence.

New Short-Wave Observer Appointments

The directors of the DX Corner announce

The **DX**
for
SHORT

Conducted by

the appointments of and welcome the following short-wave enthusiasts as Official Radio News Listening Post Observers: Joseph W. Brumfield, Delaware; George M. Fleming, Missouri; Elbert Gross, Harold Murray, New York; Raymond Hernday, Warren H. Stark, Wisconsin; Wayne E. Wicks, California; M. R. Kiser, Jr., North Carolina; William Skinner, Michigan; Steve Beno, Nebraska; Elmer F. Shields, Maryland; A. F. Hairbottle, Australia; Bill Lander, New Zealand; J. Burton, Wales.

Reports of Listening Post Observers and Other Short-Wave Readers of the DX Corner

LISTED in the following columns is this month's consolidated reports of short-wave stations heard by our worldwide listening posts. Each item is credited with the Observer's surname. This allows our readers to note who obtained the information. If any of our readers can supply Actual Time Schedules, Correct Wavelengths, Correct Frequencies and any other Important Information (in paragraphs as recommended), the DX Editor, as well as our

readers, will be grateful for the information. On the other hand, readers seeing these reports can try their skill in pulling in the stations logged and in trying to get complete information on these transmissions. The report for this month, containing the best information available to date, follows:

Europe

TFJ, Reykjavik, Iceland, 12,230 kc. Daily 2:20 p.m. (Sporn) 1:40-2:30 p.m. on Sunday (Portner. Goetsch).

HAS3, Budapest, Hungary, 15,370 kc. Sunday 9-10 a.m. (Markuson, Partner).

PHI, Huizen, Holland, 17,770 kc., Monday 7 p.m. (Sahlback) 9,590 kc. Sunday, 7-8 p.m. and 9-11 p.m. (Doyle).

LKJ1, Oslo, Norway, 9,535 kc., Monday and Tuesday 6:30-7:30 a.m. Hesterman.

SPW, Warsaw Poland, 13,690 kc.. Sundays 12:30-3:30 p.m. and Monday, Wednesday and Friday, 12:30-3:30 p.m. Hedgeland, Unger, Smith Shamleffer, Testing Sunday 12-1:30 p.m. (Skinner) Sunday 11:30 a.m.-1:30 a.m. Address 5 Mazowiecka St. (from veri) Magnuson, Portner, Skinner, Craston.

ORK, Brussels, Belgium, 10,330 kc.. Daily 1:30-3 p.m., Hartzell, 8:20 p.m. Sporn, Portner, 10,400 kc. Doyle.

LZA, Sofia, Bulgaria, 14,970 kc.. Weekdays 6-7:30 a.m. and 1-3:34 p.m. Sunday, 1 a.m.-5:30 p.m., Unger, Shea. Monday, Wednesday, Friday and Sat-

HERE'S THE DOPE ON HP5A

At last, here is the dope on the new Panama station, from a verification received by Observer Noyes of Omaha, Nebr.

Apartado 854
Panamá, R. de P.

Telegramas:
RADIOSTAR
PANAMA

Latitud: 9° 2' N.
Longitud: 79° 0' O.

Frecuencia: 11,700 Kc.
Potencia: 500 vatios.

Panamá, Rep. de Panamá, July 25, 1937.

Estimado..... señor.....

Le..... avisamos recibo de su informe de recepción de fecha July 18, 1937

y le agradecemos los datos que nos da sobre la buena llegada allí de nuestra emisora, Hemos verificado su recepción y la encontramos correcta. Le agradeceremos nuevos informes.

We are very thankful for your excellent report. Will send you regular programs.

Atentamente,

RADIO-TEATRO ESTRELLA DE PANAMA,
A. Noyes
Administrador.

Corner

the

WAVES

L. M. Cockaday



A POPULAR SOUTH AMERICAN "VERI"
Lee Meade Williams, observer for Maryland, sends in this card from Radio Caracas. The coat of arms on the mike is of that city, which was originally named Santiago de Leon.

urday 5-7 a.m. and Tuesday and Friday 12:30-8 a.m. and Sunday 10 a.m.-4:30 p.m. Mathews, Gallagher.

PCJ, Huizen, Holland, 15,220 kc., Tuesday 4:30 a.m.-6 a.m. and Wednesday 8-11 a.m. Kiser, Millen, 9,590 kc., Eder, Lindner, Nowak, 9,590 kc., Alfred Sunday, 7-8 p.m., Dressler, Duncan, Sunday 2-4 p.m. (from veri) Gertenbach, Slogan: "The Happy Station" Fleming, Diez, Tuesday, 12:30-2 p.m. Thursday 7-10 a.m. Riajchowski, Schmidt, Nigh, Shamleffer, Portner.

HAT4, Budapest, Hungary, 9,120 kc., Eder, Sunday 7-8 p.m. and Wednesday and Saturday, 6-8 p.m. Dressler, Schmidt, Saturday, 6-7 p.m. only, Hartzell, Portner, Doyle.

YUA, Belgrade, Yugoslavia, 6,100 kc., Slogan: "Radio Belgrade." (veri) Blanchard Hedgeland, Address: Miloas Velikog 16, Belgrade. 12:45 a.m.-6:20 p.m. with intervals, Pierko, Wilson.

OXY, Skanlebaek, Denmark, 6,060 kc., Heard 8 a.m. Hedgeland, Daily 10 p.m.-12:30 a.m. Shea, 11,803 kc. and 15,153 kc. On former frequency Monday and Saturday 3-7 p.m. irregular. On latter 4 p.m. irregular, Portner, Skinner.

SBG, Motala, Sweden, 15,150 kc., Daily 1:45 a.m. and on, Hegeland. Shea, Sunday 12-4 p.m. Magunson, 11,700 kc. Daily 11 a.m.-3 p.m. Partner, Doyle, Matthews.

OER2, Vienna, Austria, 6,072 kc., Hedgeland, 11,901 kc., Daily 9 a.m.-5 p.m. Partner Atherton, Doyle.

EAJ8, Bilbao, Spain, 7,260 kc., 3:30-9:30 p.m. Sporn.

EAQ1, Madrid, Spain, 9,860 kc., 7-10 p.m., McCartin, Daily 6-9 p.m. Dressler, 5-7:30 a.m. Sporn 9,500 kc. 3-6 a.m. Doyle, Pickering.

EAQ2, Madrid, Spain, 9,480 kc., 12-7 a.m. McCartin, Piorko, Dressler, Scully Jaime, 9,500 kc., 9,490 kc., Fleming, Daily 3-9:30 p.m. Partner, Pickering, Wittig. Slogan: "La Voz de Espana" Address: P. O. Box 951.

DJR, Zeesen, Germany, 15,340 kc., Eder, 8:45 p.m., Nowak 8-9 a.m. Alfred Wollenschlager, 4:50-10:45 p.m. Daily, Shamleffer, Doyle.

DJQ, Zeesen, Germany, 15,280 kc., Daily except Sunday 1:10-5 a.m. and Daily 6:35-12 a.m. Hedgeland, 8:45 p.m. Nowak, Alfred Wollenschlager, Jordan, Daily 5:50-10:45 p.m. Sunday 11:10 a.m.-12:25 p.m. Shamleffer, Fleming, Doyle, Eder.

DJA, Zeesen, Germany, 9,560 kc.,

Eder, Daily except Sunday 1:10-5 a.m. Hedgeland, Shamleffer, Daily 4:50-10:45 p.m. Dressler, Alfred, Diez, Doyle.

DJB, Zeesen, Germany, 15,200 kc., Eder, Daily except Sunday, 1:10-5 p.m., 6:55-12 a.m. Hedgeland, Daily 4:50-10:45 p.m. Dressler, Alfred Wollenschlager, Fleming, Shamleffer, Doyle. Hesterman, 15,340 kc. Wittig, Gallagher.

DJD, Zeesen, Germany, 11,770 kc., Daily 11:35 a.m.-4:30 p.m. Hedgeland. Daily 4:00-10:45 p.m. Dressler, Alfred, Wollenschlager, Lindner, Fleming, Schmidt, Hams, Shamleffer, Doyle, Wittig, Eder.

DJE, Zeesen, Germany, 17,750 kc., Daily 1:10-5 a.m., 3:55-11 a.m. Hedgeland, Daily 3-6 p.m., 7-11 a.m. Pena, Sunday 11:10 a.m.-12:35 p.m. Shamleffer, Doyle.

DJL, Zeesen, Germany, 15,110 kc., Daily except Sunday 1:10-5 a.m., 8-9 a.m., 11:35 a.m.-4:30 p.m. Hedgeland, 7:45-9 a.m. Alfred, Wittig, Wollenschlager, Fleming, 12-2 a.m. Sporn, Shamleffer.

SOME "SHOTS" FROM CT1AA

Scrambled scenes at the popular Portuguese station. At top: A speaker and transmitter. Center: The cuckoo call. Below: Speech amplifiers and the station owner.

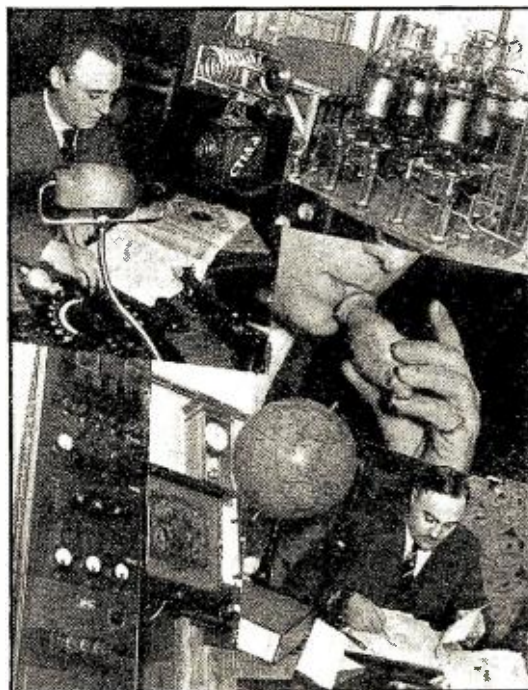

DJN, Zeesen, Germany, 9,540 kc., Daily except Sunday, 1:10-5 a.m. 5:55-11 a.m. Hedgeland, Shamleffer, Daily 4:00-10:45 p.m. Dressler, Alfred, Fleming, Wittig.

TPA3, Pontoise, France, 11,880 kc., 4-5 a.m., 10:15 a.m.-5 p.m. Kiser, Fleming, 1-4 a.m. Partner, Shamleffer, Doyle, Wittig.

TPA4, Pontoise, France, 11,720 kc., 2 a.m. and m. McCartin, Daily 6-8 p.m. and 10 p.m.-1 a.m. Markusen, Monday and Friday, 9-10 a.m. Pena, Dressler 5:15 p.m. midnight, Partner, Doyle, Gallagher.

TPA2, Pontoise, 15,240 kc., 10-11:05 p.m. Sporn, 12:30-2:30 p.m. Doyle, Gallagher, Eder.

2RO3, Rome, Italy, 9,635 kc. Monday, Wednesday and Friday, 6-7:30 p.m. and Tuesday, Thursday and Saturday 6-7:45 p.m. Kiser, Sporn, 11,810 kc. Alfred, Jaime, Marshall, Beno. 11,745 kc. heard irregular, Diez, Partner. Sunday 7:40 a.m.-6:30 p.m. and midnight Wednesday and Friday. 7:43 a.m. 8:30 p.m., Tuesday, Thursday and Saturday, 7:43 a.m.-8:45 p.m. Meehan.

I2RO4, Rome, Italy, 11,810 kc., Hedgeland, 9:15 a.m. 7 p.m. McCartin. Shamleffer, Daily 1:30-5:30 p.m. Dressler, Monday, Wednesday and Friday, 6-7:40 p.m. Fleming.

Radio Liberte, Milan, Italy, 9,523 and 7,386 kc., 7-8 p.m. Daily Shea.

HBJ, Geneva, Switzerland, 14,335 kc., Hedgeland, Saturday 7-8:45 p.m. Alfred, Jordan, Markuson, Shamleffer, Eder.

HBL, Geneva, Switzerland, 9,590 kc. Saturday 5-7 p.m. McCartin, Jaime. Markuson, 9,345 kc., Partner, 9,345 kc. Doyle.

HBO, Geneva, Switzerland, 11,402 kc., 7:17 p.m. Jaime, Saturday, 7-8:45 p.m. Alfred, Markuson, Shamleffer, Doyle, Bell, Eder.

HBP, Geneva, Switzerland, 7,797 kc., 5:37 p.m. Jaime, Saturday 5:30 p.m.-6 p.m. Markuson.

OLR5A, Prague, (Podebrady) Czechoslovakia, 15,230 kc. Monday and Thursday, 8-10:15 p.m. Kiser, Eder. Daily 2-2:15 p.m. Wants reports. Blanchard, Ruiz, McCartin, Fruax, Alfred, Lander, Sculley, Beno, Markuson, Fleming, Shamleffer, Partner, Hesterman.

OLR4A, Prague, Czechoslovakia, 11,840 kc., Monday and Thursday, 8-10:10 p.m., Ruiz, McCartin, Daily 2:30-

(Turn to page 304)



AN "INFINITE BAFFLE" CONSOLE

The new console is not only highly attractive, but employs the bass-reflex principle in its design, with the result that reproduction of low notes is unusually realistic. The photograph below shows the back of the speaker compartment completely enclosed. This is one feature of this new speaker-cabinet principle.

MANY DX and short-wave listeners will be interested in learning that the Hammarlund "Super-Pro" communications receiver is now available in the form of a "home" model. The "communication" model of this receiver has proven highly popular and effective among amateurs and professionals in various commercial services, but for the short-wave enthusiast the broadcast band DX'er, etc., whose receiver is usually installed in the living room where it serves the whole family, the multiple controls on the front panel of the communications model have proven to be somewhat bewildering under the hands of the lady of the house.

IN this new model a number of the controls have therefore been eliminated. These controls are those which served special purposes for the "ham" or the professional operator but which offer no particular advantage to the DX'er or the short-wave listener. This new model is shown in the accompanying photographs and from the following list of controls on the front panel it will be realized that a wide range

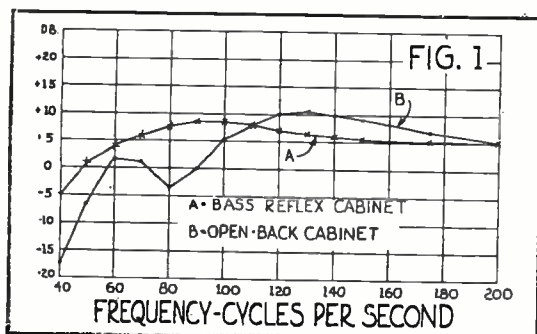

The Latest "SUPER-PRO" for the Living Room

By Gordon Fraser

of operating flexibility has still been retained. These controls are, from left to right: i.f. band width (selectivity—fidelity), a. v. c. — manual switch, main tuning, combined r.f.-i.f. sensitivity, band-spread tuning, beat-frequency oscillator switch with phone jack below it, and combined a.f. gain control and a.c. switch. The large knob between the two dial windows is the band selector switch and above it is the tuning, or signal strength, meter.

The receiver employs exactly the same circuit as the communications model which was described in considerable detail in the February and March 1937 issues. Fourteen tubes are employed and the circuit includes two stages of tuned r.f., separate oscillator and mixer tubes, an i.f. amplifier which provides bandwidth variation from 3 to 16 kc., a beat-frequency oscillator as an aid in finding weak stations or in reception of c.w. signals, amplified a.v.c. and a 4-tube audio system capable of delivering much more output power than can be used in the home.

New Reproducer System

In addition to the simplification of operation, this new model offers the advantage of a 15-inch high-fidelity loudspeaker and a console cabinet which employs the new bass-reflex principle which results in more realistic reproduction of the lower tones. This is accomplished by completely closing the back of the loudspeaker compartment and providing a porthole of exactly the right dimensions in the front of the cabinet just below the speaker opening. The effect of this arrangement is that of an infinite baffle. Moreover, inasmuch as the back of the cabinet is completely closed, it may be set flush against a wall with no loss in quality of reproduction.

Better Bass Response

Figure 1 shows the effect of this closed console in improving bass reproduction below 200 cycles per second. Curve B is the measured characteristic when the

front porthole is covered and the rear cover is removed—in other words, when the cabinet employed is a typical, open-back type. Curve A is the measured characteristic when the back is added and the front port provided. It will be noticed that from 40 to 110 cycles the bass response is smoother, and at a higher level. From 110 to 200 cycles the response indicated by Curve A is almost flat whereas in Curve B the characteristic is rising, indicating so-called cabinet resonance and "boomy" quality. Above 200 cycles the characteristic remains the same whether the cabinet is open or closed.

Other Features

It might be added here that this console is now available, fitted with any of the Super-Pro models.

The improvement in the speaker and the provision of the bass-reflex console, coupled with the adjustable band-width feature of the receiver provide high-fidelity reproduction even greater than that provided in the earlier models of this receiver. The audio-frequency range, incidentally, is greater than that employed by the average good broadcast station. Phonograph connections are provided at the rear of the chassis and also a knob for varying the pitch of the beat oscillator note is provided inside the receiver on the can of the beat-frequency oscillator transformer. For the DX listener or short-wave enthusiast who does his listening late at night, the head-phone jack on the front panel will prove convenient.

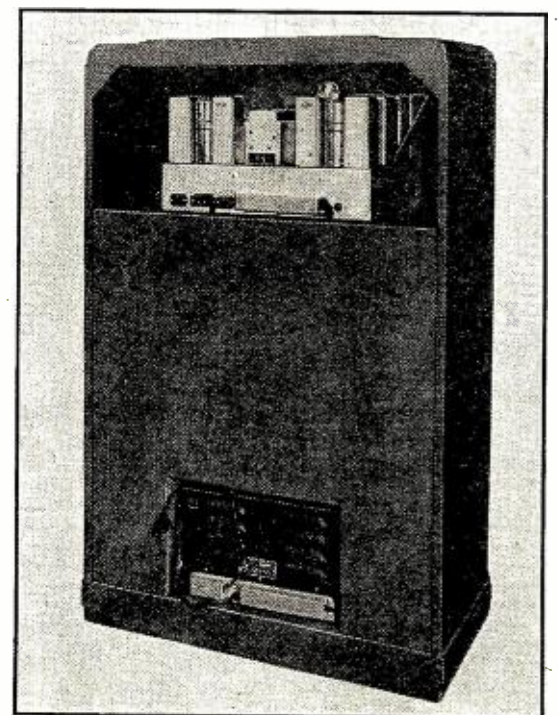

OCT. 31st
Your last chance

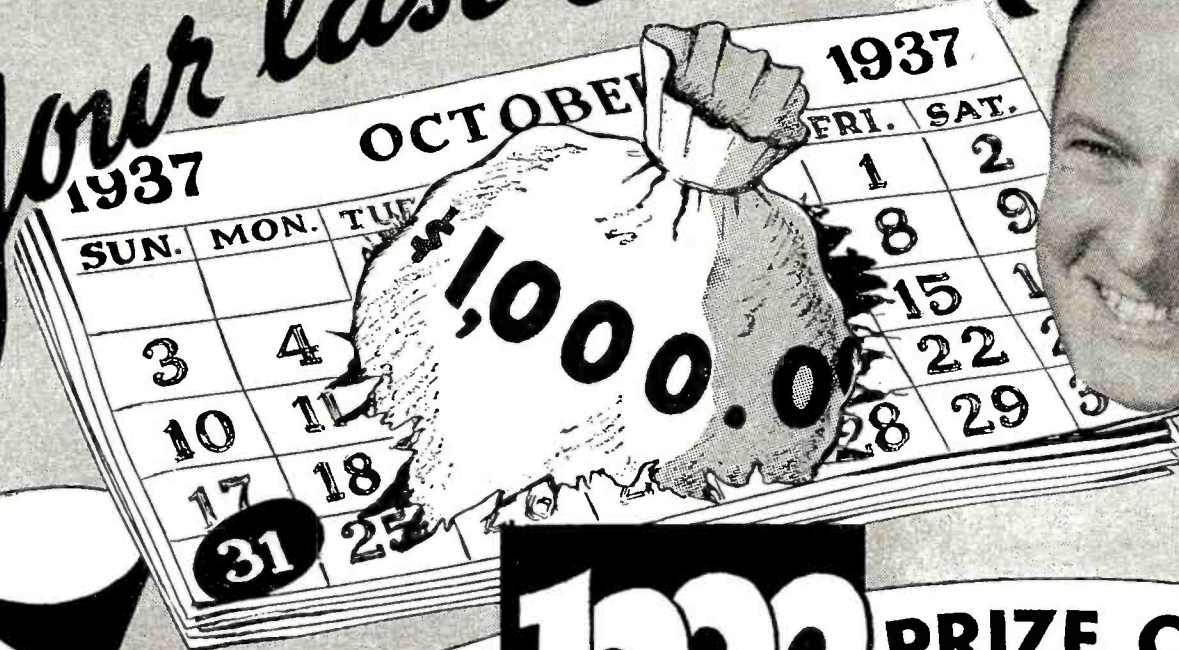

TO WIN in the \$1,000 PRIZE CONTEST

HERE'S WHAT YOU CAN WIN ... PUBLIC ADDRESS EQUIPMENT

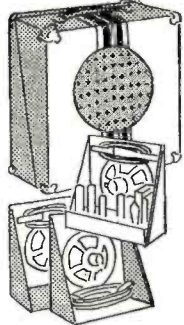

Famous LAFAYETTE P.A. Systems in all sizes for every conceivable requirement or demand. A complete NEW line of modern sound systems, portable and permanent, at prices low enough to furnish you with a handsome profit. New colors, stream-lined designs, lightweight, non-corrosive steel cabinets, special illuminated control dials. *Win in the contest and take your pick.*

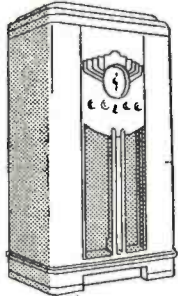

LAFAYETTE RADIOS

More than 50 LAFAYETTE models to choose from and every one from 5-tube superhet to 13-tube custom-built model a beauty! Electric Tuning, Acoustic Tone Chambers, unequalled performance feature the new 1938 line of Lafayettes. Described on 35 rotogravure pages in the catalog. *Win in the contest and take your pick.*

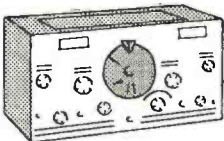

"HAM" RECEIVERS

The new 1938 catalog is a "field-day" for hams. Pictured is the greatest line of receivers, transmitters and parts ever assembled. Pages of top-notch equipment by such leading manufacturers as Hallicrafter, Hammarlund, RCA, W. E., etc.; everything a "ham" wants. *Win in the contest and take your pick.*

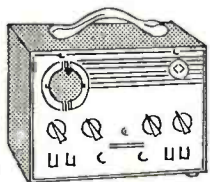

TEST INSTRUMENTS

The greatest collection of up-to-the-minute test equipment in Radio today—at Wholesale prices—rock-bottom prices that cannot be beaten. See extensive line in the new 1938 catalog. *Win in the contest and take your pick.*

Open to Everyone!

Servicemen, engineers, sound men, amateurs . . . EVERYONE, less than 30 days are left to get in on the greatest, easiest contest in years! You have a splendid chance to win one of these big prizes: **First Prize, \$250.00; Second Prize, \$150.00; Third Prize, \$100.00; and fifty other prizes of \$10.00 each!** You don't have to be "talented" to win in this contest. There is nothing to buy—no strings attached.

But you *will* have to hurry! Contest closes at midnight, October 31st. So better get busy—here is the opportunity of a *lifetime* right in your lap.

HERE'S HOW TO WIN ...

All you have to do to bag one of the big prizes is simply grab your pen and tell us in 100 words or less "Why I Have Found The Wholesale Radio Service Company Catalog Valuable". Easy? It's a natural! Prizes will be announced in the January issues of all radio magazines. To get your official application form, clip the coupon in the corner of this page and mail to Wholesale Radio Service Company, Inc. 100 Sixth Avenue, New York, N. Y.—*immediately*. We're not only waiting to shoot your Application Form along, but a copy of the BIG New 1938 Wholesale Catalog with it—**FREE!**

FREE MAIL COUPON FOR 180 PAGE CATALOG AND ENTRY BLANK

Has more radio bargains packed between its covers than ever before. This new Wholesale Catalog will prove a gold-mine. Over 50,000 real radio "Buys". Because of our key position in the radio industry, because of our tremendous purchasing power, we can offer you these rock-bottom prices on quality merchandise. So don't wait a single day to mail the coupon for your **FREE** Catalog and contest Entry Blank.

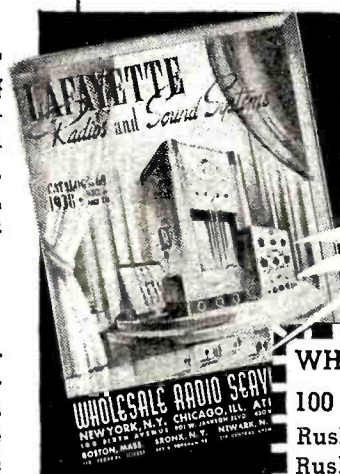

CUT THIS COUPON AND CUT YOURSELF IN ON \$1000

WHOLESALE RADIO SERVICE CO., INC.
 100 Sixth Avenue, New York, N. Y.
 Rush FREE 1938 Catalog No. 69-2L7
 Rush contest entry blank

Name.....
 Address.....
 City..... State.....

WHOLESALE RADIO SERVICE CO., INC.
 NEW YORK, N. Y. CHICAGO, ILL. ATLANTA, GA.
 100 SIXTH AVENUE 901 W. JACKSON BLVD. 430 W. PEACHTREE ST., N. W.
 BOSTON, MASS. BRONX, N. Y. NEWARK, N. J. JAMAICA, L. I.

RAYTHEON

Alone

IS RESPONSIBLE
FOR THE SALE OF
OVER...

3,000,000
FARM RADIOS!

Over ten years ago RAYTHEON developed and pioneered the 2-volt battery tube. It was the improvement the engineering world was waiting for—to make possible real radio reception in rural localities!

Since then, there has been no outstanding development until the announcement of the new RAYTHEON LOW DRAIN cathode-type tubes which permit AC operation from battery sets without excessive battery drain.

Again RAYTHEON was responsible for tripling the sales of battery receivers! When you buy replacement battery tubes with the name RAYTHEON on the base you are getting tubes made by the engineers who invented them with the added advantage of proven field experience!

RAYTHEON

443 Lake Shore Drive, Chicago, Ill.
421 Lexington Ave., New York, N. Y.
455 Howard St., San Francisco, Cal.
415 Peachtree St., N. E., Atlanta, Ga.
85 Chapel Street, Newton, Mass.



FOR BETTER RECEPTION

THE SERVICE BENCH

(Continued from page 273)

input transformer. Normal voltage between plate and ground is about 325 volts, checking with a d.c. voltmeter, 200-ohms-per-volt. Replace this condenser with a .1mfd. 600-volt type."

SERVICE NOTES

Watch for an interesting routine case of servicing with an oscilloscope in the next issue of the *Service Bench*. Too many of us lads buy oscilloscopes, play with them for a little while under controlled conditions and then never use them except to show some admiring friend what his (or her) voice looks like on the screen!

We've had several inquiries from Canadian servicemen for more dope on Canadian receivers—particularly on lining-up. So some of you lads north of the border glance through your service notes and send along some dope. We'll pay you for it—and you'll be doing a good turn for some of the brethren up Saskatchewan way!

Speaking of Canadian servicemen, about the liveliest semi-local service organization in North America is the Associated Radio

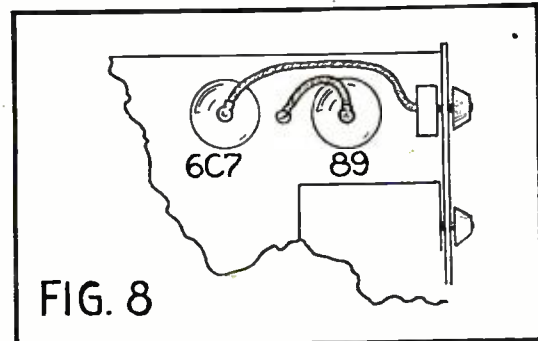

FIG. 8

Figure 8. Showing the correct connection in the Majestic auto-radio—illogical but correct.

Technicians of British Columbia, with headquarters in Vancouver. Aside from regular meetings and an interesting publication they stage such things as conventions with tours through CRCV, banquets and dances, stag parties, etc. More power to the gang and Tom Brown!

Philco has come out with a new one-year guarantee plan, full details of which are (Turn to page 309)

Communication "14"

(Continued from page 271)

The coils and band switch are so connected that the low-frequency bands are at the left hand or counter-clockwise position of the band switch.

The air-tuned trimmers and the padder assemblies have been factory-adjusted to approximately the correct capacities. If the other parts of the receiver are functioning properly reception should be obtained on all bands without further adjustment. However, variation in the placement of parts, tubes and circuit wiring may necessitate slight realignment. In this case a signal generator and an output meter will speed up the procedure.

Align the i.f. channel to 456 kc and "pad" and "align" r.f. and oscillator at the following frequencies for each band

Band No.	Range	Align At	Pad At
1	550-1560 kc	1400 kc	600 kc
2	1560-4400 kc	3960 kc	1750 kc
3	4.3-12 mc	10.0 mc	4.75 mc
4	11.38-32.0 mc	28.0 mc	Fixed
5	32.0-60.0 mc	Fixed	Fixed

Further details on aligning are presented in the instruction booklet.

This receiver is now being tested at a Radio News Listening Post. A report of its performance will be presented in an article to follow next month.

Parts List

- 1 Meissner coil and tuning kit No. 7502 containing:
 - 1 No. 7512 5-band tuning unit, wired and pre-aligned
 - 1 No. 15103 3-plate midget variable condenser
 - 1 No. 7453 matched pair crystal filter i.f. transformers (7436 and 7437)
 - 1 No. 7412 Ferrocart 450 kc band-expanding i.f. transformer
 - 1 No. 5742 Ferrocart 456-kc output i.f. transformer
 - 2 No. 6762 456 kc. single tuned diode i.f. transformer
 - 1 No. 6753 456 kc. beat-frequency oscillator transformer
 - 5 No. 5590 shielded r.f. chokes
 - 1 25,000 ohm i.f. gain control potentiometer
 - 1 5,000 ohm noise-level control potentiometer
 - 1 500,000 ohm audio volume control
 - 1 25,000 ohm tone control potentiometer with switch
 - 1 5,000 ohm a.v.c.-level control potentiometer
 - 1 125-ohm, 5-watt resistor
- 2 500-ohm, ½ watt resistors
- 1 1,500-ohm, ½ watt resistor
- 1 5,000-ohm, ½ watt resistor
- 1 30,000-ohm, ½ watt resistor
- 2 30,000-ohm, 1 watt resistors
- 2 1,000-ohm, ½ watt resistors
- 1 40,000-ohm, ½ watt resistor
- 4 50,000-ohm, ½ watt resistors
- 3 100,000-ohm, ½ watt resistors
- 3 250,000, ½ watt resistors
- 2 .01-mfd, 200-volt tubular paper condensers
- 1 .05-mfd, 200-volt tubular paper condenser
- 7 .1-mfd, 200-volt tubular paper condensers
- 1 .01-mfd, 400-volt tubular paper condenser
- 2 .05-mfd, 400-volt tubular paper condensers
- 6 .1-mfd, 400-volt tubular paper condensers
- 1 .00005-mfd mica condenser
- 2 .0001-mfd mica condensers
- 2 .00025-mfd mica condensers
- 1 .0005-mfd mica condensers
- 1 10-mfd, 35-volt electrolytic condenser
- 3 8-mfd, 450-volt electrolytic condensers
- 1 13" x 17" x 3" metal chassis (Meissner 18282)
- 1 power trans. 110 volt primary; 775-volt secondary c.t., 200 ma.; 6.3-volt sec., 5.0 amp.; 5 volt, 3 amp.
- 3 2-pole, 5-position rotary switch (Meissner 18254)
- 1 5-prong speaker plug
- 1 push-pull input audio transformer
- 1 12-henry, 231-ohm, 130-ma., filter choke
- 1 dynamic speaker with output transformer to match 6L6's in push-pull; 1250-ohm field
- 1 line cord and plug
- 1 ½-inch rubber grommet for line cord
- 2 ⅜-inch rubber grommets
- 2 special brackets (See instructions)
- 2 lengths extension shafting, ¼-inch dia.
- 2 ¼-inch shaft couplings
- 2 twin-tip jack strips
- 5 metal tube grid clips
- 1 456-kc. quartz crystal, mounted
- 3 6.3 v., .15 a. dial lights
- 9 3-terminal tie-lugs
- 6 2-terminal tie-lugs
- 1 4-terminal tie-lug
- 10 octal sockets, one 4-prong socket, two 5 prong sockets
- 3 6K7 tubes, two 6J7, two 6L7, one 6R7, one 6C5, two 6H6, two 6L6, one 5Z3
- Miscellaneous assortment of machine screws, nuts, lockwashers, and soldering lugs

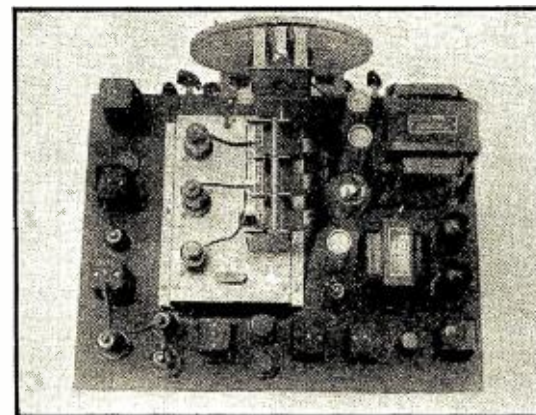

**RCA ALL
THE WAY**

RCA Radio News

RCA Manufacturing Company, Inc. • Camden, New Jersey
A Service of the Radio Corporation of America

**EVERYTHING IN
RADIO-MICROPHONE
TO LOUDSPEAKER**

To the consumer, RCA means high quality performance at low cost...To the radio man, RCA means easier selling, higher profits

A SHORT WAVE SENSATION

RCA Victor Overseas Dial Brings New Ease to Tuning of Short Wave Stations

Thousands Laud New Extra-Value Features of 1938 RCA Victor Radios

"Push A Button—There's Your Station" With Electric Tuning and Armchair Control

Now it's as easy to tune for short-wave stations as it is to tune for domestic ones! That's why short-wave fans are acclaiming the new RCA Victor Overseas Dial.

This revolutionary tuning device carries names of foreign stations on dial scales. Each of the band scales are 9½" wide. Compare this with the usual ¼" or narrower segments on most short-wave dials and you will see for yourself that short-wave stations are spread 50 times wider apart on the Overseas Dial. As a result, tuning for foreign stations is much easier than ever before. Large, easy-to-read dials are one of the important features of all new RCA Victor radios.

Another RCA Victor tuning sensation in the new sets is Electric Tuning. Push a button—there's your station. That's all

you have to do to get any one of your eight favorite stations. You can have Electric Tuning with Armchair Control—an ingenious device which permits push-button tuning from across the room, another room, or any place else that's convenient.

In all, the 1938 RCA Victor line provides 55 great features, including Sonic-Arc Magic Voice, Magic Brain, Magic Eye, RCA Metal Tubes. Ask your local RCA Victor dealer to tell you about *all* the features. Buy your radio the wise way—on proof. There are 39 new models with prices to suit you. All RCA Victor radios are available on C.I.T. easy payment terms.

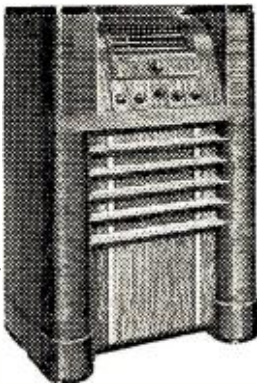

RCA Victor Model 813K featuring new Overseas Dial and Electric Tuning. 13 tubes, new Sonic-Arc Magic Voice, Magic Brain, Magic Eye, RCA Metal Tubes. Covers standard broadcast band and 49, 31, 25 and 19 meter bands of international entertainment. Armchair Control available at slight extra cost. Yours for \$15 down.

Amateurs Get Instrument They've Always Wanted—At Low Price



New, 16-tube communication receiver provides plus performance at low price.

Its performance shouts "custom-built"—yet you can afford its price! That's the ACR-111, RCA's new communication receiver. This exceptional instrument has every desirable feature for communication service. Meets every requirement of modern high frequency communication—takes the most trying conditions in its stride.

The ACR-111 provides exceptional sensitivity, limited only by the tube noises common to all signal-input tube circuits. An efficient antenna coupling system is provided to permit the use of receiver's inherent sensitivity.

Selectivity is the maximum consistent

with requirements of communication service. Unusual frequency stability and reliability have been achieved by careful electrical circuit design and the use of rugged circuit components.

Among its outstanding features are the constant-percentage electrical band-spread system, noise suppressor, 2 r. f. and i. f. stages.

Cabinet, or rack mounting, models for only \$189.50 at the factory. Free descriptive folder available without cost, from your supplier.

NOTE THESE FEATURES:

- 16 Tubes (14 All-Metal, 2 Glass) . . . 540-32,000 kes. Continuous . . . 2 Tuned R-F Stages, 2 I-F Stages . . . Constant-Percentage Electrical Band-Spread . . . Noise Suppressor . . . Noise Limiter . . . Quartz Crystal I-F Filter . . . Electron-Ray Tuning Tube and Signal-Strength Indicator . . . 3 Magnetite Core I-F Transformers . . . Delayed and Amplified A.V.C. . . . Unique Stand-by Pilot Light . . . All Controls on Front Panel . . . Separate Dust-proof 8-inch Dynamic Speaker . . . Band Change by Self-cleaning Switch . . . Handsome, Rugged Metal Cabinet . . . Individual Dial for Each Range . . . Dial Calibrated in Megacycles . . . Separate Calibration-Spread Dial . . . High Signal-to-Noise and Image Ratio . . . Large Tuning Knobs with Crank Handles.

Free Central Phone Number Plan Uncovers RCA Check-Up Prospects

RCA Pays All Costs of Most Spectacular Check-Up Promotion Ever Offered Radio Service Dealers

RCA has introduced a new way of making the famous Check-Up Plan produce extra profits for radio service dealers! Thousands have profitably hooked up to the Check-Up through a central telephone number!

This spectacular promotion again proves that wise dealers make money when they handle RCA Tubes. For RCA is always behind them—helping them sell with consumer promotions. Here's how this latest promotion worked: All RCA Tube Check-Up advertising in newspapers featured a central telephone number—having no connection with either distributor or dealer. People desiring an RCA Check-Up called this number and an operator relayed the call to the consumer's nearest qualified RCA Tube dealer. Prospects no longer wondered where to call, whom to see when



*Put new life in your
OLD RADIO!*

RCA's 10-Point Check-Up will make it Live Again! Costs only \$1.50

CALL (Phone) **0000** now! For your nearest Authorized RCA Service Engineer. He recommends RCA Radio Tubes.

they needed a radio Check-Up. One number, easy to remember did the trick.

Attention-getting, hard-selling, 4-inch ads like the one above appeared on the radio page of newspapers three times a week. These Check-Up convincers produced amazing results—bringing radio service dealers job after job.

RCA also provided free sales helps, including post-cards, check-up tags, direct mail letters, and many others—all of which helped create new business and many profitable sales.

Everyone with a radio set over a year old is a prospect for the RCA 10-Point Radio Check-Up. Not only does the Check-Up give you a worth-while service profit margin but it also makes prospects pay for being discovered—for it reveals to you the people who need new radios, electric irons, refrigerators and the varied other electrical appliances you carry. See any RCA or Cunningham tube distributor for further details.

MAKES RADIO AS Easy AS ABC

Let Ghirardi Teach You. RADIO PHYSICS COURSE \$4-

972 pp. COURSE \$4-

Easy as "rolling off a log", is this new double-quick Ghirardi method of mastering radio. No "lessons". No correspondence. Instead, a COMPLETE course on RADIO, ELECTRICITY, and SOUND—now available to you in one inexpensive, big 972-page home-study book. You just read it like you would a story. Ghirardi makes everything so clear, simple and to the point, that you understand it perfectly the first time—even if you've had no previous electrical training. His 508 specially prepared diagrams and illustrations are marvelous for making important facts and explanations clear! It's as simple as A B C. And, in the RADIO PHYSICS COURSE, Ghirardi gives you all there is to know about radio—yes, the equal of at least 36 ordinary books all rolled up in one! It's "the book of a million radio facts"—the world's radio knowledge between two covers! Because it really succeeds in making everything about radio so easy, it is used in the courses of more radio schools than any other radio book in the world! Instructors say it is the best there is at any price! But it costs you only \$4—so GET IT NOW and start your radio training tomorrow! It's EASY this way! MAIL THE COUPON BELOW—AT ONCE! Remember, EVERY PENNY of your money back if not fully satisfied.

WHAT YOU WILL LEARN FROM THIS BOOK!

Sound, Speech and Music . . . Electrons . . . Electric Current . . . Electric Units and Circuits . . . Resistance . . . Ohm's Law . . . Batteries . . . Magnetism . . . Electromagnetism . . . Transformers . . . Inductance . . . Condensers . . . Alternating Current Circuits . . . Filters . . . Electrical Measuring Instruments . . . Radio Waves and Radiations . . . Broadcast Stations . . . Receiving Equipment . . . Vacuum Tubes . . . Radio and Audio Frequency Amplification . . . Superheterodynes . . . Loud Speakers . . . Battery Operated Receivers . . . Power Supply Units . . . Electric Receivers . . . Automobile and Aircraft Receivers . . . Phonograph Pickups . . . P. A. Systems . . . Short-Wave Receivers . . . Photoelectric Cells . . . Television . . . Antennas and Grounds . . . Testing and Servicing Receivers . . . Sound Motion Pictures . . . Appendices . . . 856 Review Questions for Self-Study . . . AND LOTS MORE!

Snip this Coupon out! -MAIL IT NOW!

RADIO & TECHNICAL PUBLISHING CO.
45 Astor Place, New York, N. Y.
Dept. RN-117
Enc. and \$4. Send my RADIO PHYSICS COURSE at once, postpaid. (Foreign \$4.50)
 Send me a free circular describing this book.

Name _____
Address _____

MONEY-BACK GUARANTEE!

To Servicemen and Dealers DO YOU KNOW THAT

TRIAD

MANUFACTURES OVER 100 TYPES OF
Glass and Metal
BALLAST TUBES
(Resistor Units)
WHICH ARE AVAILABLE THRU
YOUR JOBBER—FOR INCREASING
REPLACEMENT BUSINESS
ALSO A COMPLETE LINE OF RADIO
RECEIVING TUBES

WRITE FOR PARTICULARS
—A PROFITABLE LINE TO HANDLE—

TRIAD MANUFACTURING CO., Inc.
PAWTUCKET RHODE ISLAND

THE QUALITY NAME IN RADIO

RADIO PHYSICS COURSE

ALFRED A. GHIRARDI

Lesson 67. Meters

THE foregoing objectionable features of the original form of tangent galvanometer, led to its improvement by several men, but perhaps the most important improved form was that of D'Arsonval. This is called the D'Arsonval galvanometer, after its inventor, and is shown in simple form at (B) of Figure 1. Its construction and operation is as follows:

A permanent horseshoe magnet is placed with its poles as shown and a movable rectangular coil of very fine insulated wire is suspended between the poles at the top by a fine phosphor bronze or steel wire which also serves as one current lead from the coil. The other connection is in the form of a very flexible spiral of soft copper ribbon connected to the bottom of the coil, but exerting no appreciable restraint to its rotation. When the current to be measured flows through the coil, a magnetic field is produced in and around it, the poles being at the back and front faces of the

coil as usual. The attraction between the S pole of the coil and the N pole of the permanent magnet, and that between the N pole of the coil and the S pole of the permanent magnet causes the coil to turn around in a clockwise direction (looking down on the top), the amount of deflection being approximately proportional to the current flowing through the coil. The coil will of course move clockwise or counter-clockwise depending on the direction of the current through it.

The tendency to rotate is opposed by the twisting or torsion of the suspension wire, and the motion continues until the turning effort (or torque) due to the current is equal to the opposing torque of the suspension wire. A stationary cylindrical soft iron core is placed inside of, and clearing the coil, and is supported from the back. Its purpose is to strengthen the magnetic field between the poles of the permanent magnet, by reducing the reluctance of the flux-path, and hence it makes the instrument more sensitive; that is, a given current sent through the instrument will produce a larger deflection of the coil.

It must be remembered that the coil rotates freely in the small annular space between the magnet poles and the soft iron core. If the coil is wound on a thin non-magnetic metallic frame such as aluminum, the instrument is very "dead beat", for the instant the coil moves, eddy currents are induced in the frame in such a direction as to tend to stop its movement. This damps the motion of the coil so it quickly comes to rest when the current flow through the coil is stopped or when it is deflected to any position, instead of oscillating back and forth for several seconds.

A mirror is usually attached to the coil so that a beam of light from an incandescent lamp, directed on it by a system of lenses, will be reflected back on to a semi-circular graduated scale placed about one meter from the mirror. When the coil deflects, the mirror deflects with it and the light is reflected back to the scale at an angle as shown at (C). Thus a very small deflection of the coil and mirror will produce as very much enlarged or amplified deflection of the beam of light on the scale so that it can be read accurately by means of a telescope.

The small lamp which produces the beam of light, and the telescope and scale are supported at the left by an arm. The galvanometer movement and mirror are enclosed in an iron case which shields it from external magnetic fields and is arranged to be mounted on a wall. Since the

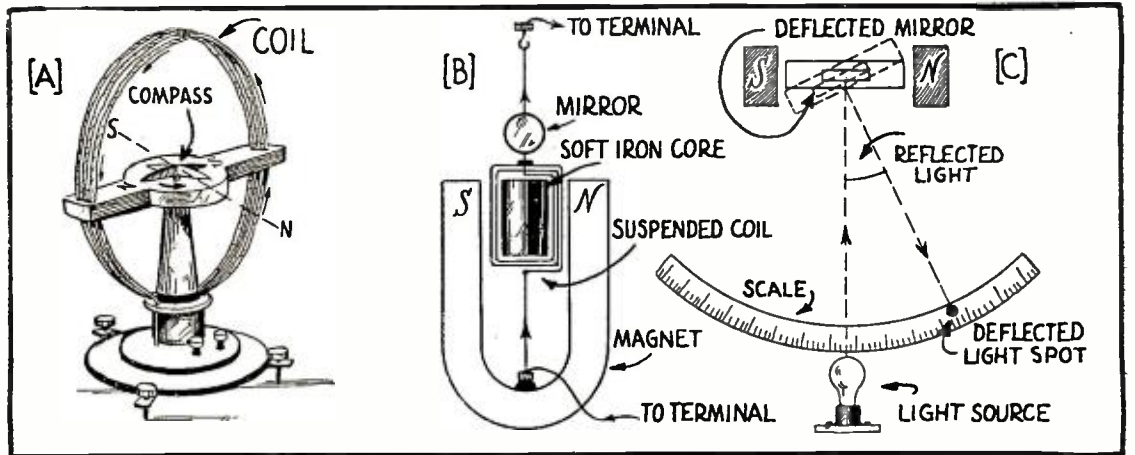

Figure 1. (A) Simple form of tangent galvanometer. (B) D'Arsonval galvanometer movement. (C) Light beam arrangement for amplifying movements of the mirror.

coil as usual. The attraction between the S pole of the coil and the N pole of the permanent magnet, and that between the N pole of the coil and the S pole of the permanent magnet causes the coil to turn around in a clockwise direction (looking down on the top), the amount of deflection being approximately proportional to the current flowing through the coil. The coil will of course move clockwise or counter-clockwise depending on the direction of the current through it.

The tendency to rotate is opposed by the twisting or torsion of the suspension wire, and the motion continues until the turning effort (or torque) due to the current is equal to the opposing torque of the suspension wire. A stationary cylindrical soft iron core is placed inside of, and clearing the coil, and is supported from the back. Its purpose is to strengthen the magnetic field between the poles of the permanent magnet, by reducing the reluctance of the flux-path, and hence it makes the instrument more sensitive; that is, a given current sent through the instrument will produce a larger deflection of the coil.

It must be remembered that the coil rotates freely in the small annular space between the magnet poles and the soft iron core. If the coil is wound on a thin non-magnetic metallic frame such as aluminum, the instrument is very "dead beat", for the instant the coil moves, eddy currents are induced in the frame in such a direction as to tend to stop its movement. This damps the motion of the coil so it

coil and suspensions are exceedingly light, and there are many turns of fine wire on the coil, galvanometers of this type can be made sensitive enough to give a deflection (of the spot of light) of one millimeter on a scale one meter distant from the mirror, for a current of .00000001 amperes. If a resistance of 1,000 megohms is connected in series with the moving coil, an e. m. f. of one volt applied to the meter will produce a deflection of one millimeter division. Therefore it can also be used as a voltmeter by connecting a high resistance in series with it.

An Improved Type

The D'Arsonval galvanometer is quite an improvement over the old tangent galvanometer in that it is not affected by changes in the earth's magnetic field or by external magnetic fields and can therefore be used in close proximity to electrical apparatus. It can also be built very sensitive, but it has several limitations which make it suitable only for use in laboratory work where it is permanently mounted, usually on a wall. It is too large, bulky, and delicate to be conveniently portable, also it must be carefully leveled up so the coil moves freely without touching the pole pieces. This is accomplished by the leveling screws and tension screws provided.

Notice that in the D'Arsonval instrument the permanent magnet is stationary and the coil moves. This construction in refined form is used in most direct-current electrical measuring instruments today.

The "Tiny Tot"

(Continued from page 283)

dust-proof and moisture-proof. Adequate sensitivity is provided and the grey suede finish of the little cabinet makes it attractive in appearance.

For maximum efficiency, separate antennas are employed. The receiving antenna is one of the door-hinge variety. It opens up to a length of about 5 feet and is approximately 2½ feet long when closed. A single wire lead from the antenna terminal of the receiver is clipped to its insulated base. For convenience the lead is brought through the window of the front door and is connected only when the station is in operation. The "ground" terminal of the receiver is not used.

The transmitting antenna is likewise one of the telescope type but opens up to a length of 9 feet and has a closed length of a little over 3 feet. It is supported inside the trunk on an angle bracket which is bolted to the inside steel frame of the trunk as illustrated in Figure 3. This is one of the so-called bumper antennas but with the bumper clamps removed and the two insulated mounting screws by which the clamps were attached are used to bolt the antenna to the angle iron. Where the antenna projects through the roof of the trunk, a rubber bushing is inserted to provide insulation and at the same time keep out the rain. The lead provided at the bottom end of this antenna is cut off to about 3 inches and is connected directly to the antenna terminal of the transmitter.

In deciding on the placement of the transmitting antenna, a point at one end of the trunk was selected, where it would not interfere with opening the trunk cover and where the antenna would be as far away from the body of the car as practical. Its placement as well as that of the transmitter is shown in the photograph.

In tuning up this transmitter, it is important that an O-100 ma. milliammeter be plugged into the meter jack, and to see that the current indicated on this meter never rises much above 50 milliamperes. About 42 ma. is the correct value. If the antenna coupling is too tight, it is possible to run this current up to 80 ma. or higher but if operated at this level there is a strong possibility that the 45 tube or the power supply or both may be damaged. It is not advisable to depend too much on the current readings as an indication of proper tuning adjustment. The way to tune the rig up properly is to employ a sensitive field-strength meter placed at least 30 feet from the car—or else have some station a quarter mile or more away provide checks on the different adjustments. The tuning dial, the antenna series condenser and the length of the antenna all play a part in the tuning process and each one is important if maximum results are to be obtained.

Now, just a word as to the results obtained with this rig. No serious attempt has been made as yet to determine its working range. Operated at sea level, it has been reported from numerous points within a 15-mile radius. Operating at a point approximately 100 feet above sea level, the signals were reported 88 at a point 17 miles distant. Every station contacted reports excellent quality of modulation and the signal is so stable that the quality reports are good even on resistance-coupled and 4000 kc. tuned i.f. superhets. While in motion over average roads, and especially at speeds of 35 miles per hour or more, there is some "wobulation" but the stability is reported considerably above the average for portable-mobile-rigs. Hash or other carrier noise is completely absent.

"We unhesitatingly recommend
SUPREME *test equipment"*



J. E. Smolek SERVICE MANAGER



ZENITH RADIO CORPORATION
CHICAGO, U.S.A.

Mr. Dulweber,
Supreme Instruments Corporation,
Greenwood, Miss.

Dear Mr. Dulweber:

After quite an exhaustive check on the merits of Supreme Instruments, we take this opportunity of complimenting your organization on what we believe to be an unusually fine product.

As a radio manufacturer, we must naturally have always at hand a thorough analysis of every type of test equipment, for we are called upon almost daily by jobbers, dealers and service men to offer recommendations. Since it is to the advancement of our product that we give the customer every advantage of skill in workmanship and service technique, we have unhesitatingly recommended the use of Supreme test equipment.

Wishing you continued success in the promotion of highest standards for the service profession, and assuring you that maintenance of fine quality and performance will continue to merit our endorsement, we are

Very truly yours,
J. E. Smolek
Service Manager

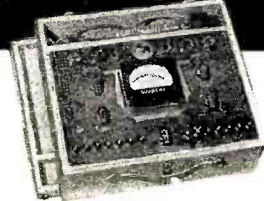

MODEL 502 tube and radio tester. 7 instruments in one! Tests tubes and electrolytic capacitors on "Good-Bad" scales. Tests electrostatic capacitors for leakage on neon lamp, plus a complete DC volt meter with ranges from 0.2 to 1400 volts in 4 ranges, plus a complete AC volt meter with ranges from 0.2 to 1400 volts in 4 ranges, plus a complete ohmmeter with ranges of 0.1 ohms to 20 megohms (self-contained power supply), plus a 4 range output meter with ranges from 0.2 to 1400 volts AC. Cash Price only \$49.95 or \$5.50 deposit and ten monthly payments of \$4.95.

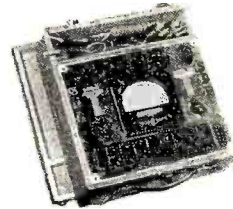

MODEL 551 analyzer provides a method of making voltage, current and resistance readings directly from the tube socket without removing the chassis from the cabinet! Can be used either as a set tester or an analyzer, and permits analysis of all voltages from 0.2 to 1400 volts AC in 4 ranges—and 0.2 to 1400 DC volts in 4 ranges at 1000 ohms per volt. Three DC current ranges of 0.7-35-140 mls. 4 output ranges from 0.2 to 1400 volts AC. Self-contained ohmmeter circuit measures from 0.1 ohm to 20 megohms in 5 ranges. Single multi-contact selector switch makes any range instantly available. 20 functions and ranges in all. Cash price only \$38.95 or \$4.25 deposit and ten monthly payments of \$3.86.

MODEL 546 oscilloscope is a full-size instrument with a 3" cathode ray tube, yet sells for no more than a miniature 1" scope. Has vertical and horizontal Spot Centering Controls on the panel, an Intensity and a



Focus Control, Synchronizing Control, Linear Sweep Range Selector, Fine Frequency Adjuster and Horizontal and Vertical Gain Controls. Use with Signal Generator for complete visual alignment of radio receivers. Cash price only \$59.95 or \$6.50 deposit with ten monthly payments of \$5.95.

YOUR PARTS JOBBER WILL SELL YOU ANY SUPREME INSTRUMENT ON S. I. C. EASY PAYMENT—THE LOWEST TERMS IN THE RADIO BUSINESS

SUPREME INSTRUMENTS CORP., Greenwood, Miss.

Export Dept., Associated Exporters Co., 145 W. 45th St., New York City, Cable Address: LCPREN, New York

WANTED—MEN

to cast Christmas Goods, 5 and 10c Novelties, Toy Autos, Ashtrays, etc. Can be done in any spare room and no experience necessary. A rare opportunity to devote spare or full time to profitable work.

METAL CAST PRODUCTS CO.
1696 Boston Road, Dept. 32, New York N. Y.

RADIO ENGINEERING



RCA Institutes offer an intensive course of high standard embracing all phases of Radio. Practical training with modern equipment at New York and Chicago schools. Also specialized courses and Home Study Courses under "No obligation" plan. Catalog Dept. RN-37.

RCA INSTITUTES, Inc.

A Radio Corporation of America Service
75 Varick St., New York 1154 Merchandise Mart, Chicago

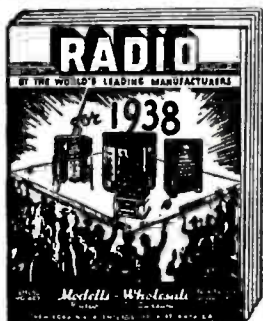

FREE!! New 1938 Radio Catalog

SERVICEMEN—Radio Salesmen and Agents—become a **MODELL** representative in your community without any investment. Earn up to \$100 a week in commissions selling Nationally Known Radios. Take orders from the largest and most complete catalog ever published, describing and illustrating the following 1938 makes: RCA—Philco—General Electric—Zenith—Motorola—Delco—Grunow—Crosley—Stromberg—Carlson—Kadette—Emerson. Join our nationwide organization. Territory is now being allotted to live wire men who are anxious to earn extra money in their spare time. Write for this big catalog and selling proposition today. No experience necessary.

Modell's Since 1889
AGENCY DIVISION, DEPT G-7

CHICAGO, Ill. | ATLANTA, GA. | NEW YORK, N. Y.
56 W. Washington St. | 57 Forsyth St. | 58 Cortlandt St.



Mr. George Rohr says:

"Centralab is the difference between a satisfied customer and a dissatisfied one."

Mr. Rohr, who twirls a mean soldering iron at 67 Thorne St., Jersey City, N. J., is one of that vast army of radio men who year after year cast their preference with Centralab.

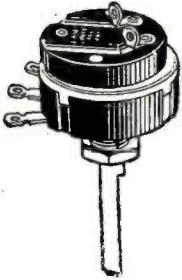

The smooth, noise-free performance of these world-famous controls explains their ever-growing popularity. For all replacements . . . CENTRALAB.

Get the 1937 Volume Control Guide

Centralab

DIVISION OF GLOBE UNION, INC. MILWAUKEE, WIS.

British Centralab, Ltd. Canterbury Rd., Kilburn London N. W. 6, England

French Centralab Co., 118 Avenue Ledru-Rollin, Paris XI, France



A SIGNAL AND ITS HEARER PASSED BEYOND OUR KEN
In memoriam: This picture of Guglielmo Marconi was taken in the Cabot Memorial Tower, December 12, 1901, just after he had received the first radio signals across the Atlantic.

QRD? QRD? QRD?

CONDUCTED BY GY

WE mourn the passing of Marconi, whose name is synonymous with radio, and whose experiments in radio led him to the highest pinnacle of fame and fortune. Who knows but he may now be trying to pierce the heavens with new radio apparatus to communicate with this earthly sphere. He never took credit away from those who preceded him in the realm of radio, but due honor must be given to him who led the way in experimenting and commercialized all these findings, making possible radio as we have it today. His vision and foresight brought forth greater and greater improvements from that early beginning at the Isle of Wight. And today we do homage to a soul who has given to the world "another seventh wonder."

DID you know that ship-to-shore radio-telephones are greatly increasing. Many organizations have requested installations but radio companies state they will not be able to reach full production until 1938. At present, shore stations are up along the West Coast in 5 or 6 places and installations are going forward on two steamship lines. Applications are before the FCC for installations in the Norfolk area and points south. Most shore stations are about 400-watts power and operate on 2,500 kc. Weather and hydro signals are being sent out from government stations in that band, or nearby. It's okay for police and air pilots to have those 3rd class phone licenses, but when mechanics, clerks and telephone ops get these tickets, it is time some one got up to make a statement.

We note the passing of Victor A. Costner, formerly radiop on the freighter Golden Bear, who died during the rescue of the inhabitants of the lava-destroyed town of Rabaul, New Britain, New Guinea. A submarine crater on Volcano Island in the harbor area suddenly burst wide open with a tremendous roar. The crew of the Golden Bear, instead of heading for the open sea, groped their way ashore in the pitch darkness, through downpours of volcanic ashes and pumice. They managed to rescue about 750 persons and carried them to an island fifteen miles distant. Costner, true to his calling, gave his all so that others might live!

According to Lieut. Frank Johnson of the Coast Guard, the crew and the Freighter West Mahwah can consider themselves lucky on being safely refloated after hitting the rocks of Pescadero Point some 48

miles below 'Frisco. The big McCormick Line freighter sailed out of 'Frisco harbor bound for Los Angeles with a general cargo in a calm sea but with foggy weather. It wasn't many hours later that Lieut. Johnson intercepted their SOS signals and immediately dispatched aid via sea and land. He states: "It's one of the nastiest spots on the coast." So sailor, beware, beware!

E. P. Chase, Jr., W2KAK, of Teaneck, N. J., will be the "radio ears" for the American Press, when Rev. Paul Schulte, flying priest of the Arctic, goes back into the frozen north again this year. Although Brother Chase has been bedridden for the past two years, he has been operating his radio daily. And last year he sent a few msgs to Father Schulte who was on his merciful rounds up there where the population hibernates for the winter. So this year Father Schulte has arranged with Chase to keep a regular schedule to clear traffic. With radio you just can't hide your light under a bushel!

A Radio law that became effective May, 1937, requires auto alarms or continuous watch on ships of 1600 gross tons or above. Most cargo ships carry the auto alarm and one radiop. This law also states that the radiop on these ships must have had at least six months experience on board a vessel before being qualified to handle an auto-alarm-equipped boat. We wonder whether shipping companies will think it cheaper to install an auto-alarm or hire three experienced men to man a continuous watch? Also, many radiops who quit the game for a time but kept renewing their tickets are finding themselves out on a limb, what with all the new apparatus like r.f. receivers, 9-tube auto-alarms, half a

Get Smart!
USE THESE NEW
SERVICE SHORT CUTS
SPEED UP YOUR SERVICE WORK with these amazing new "TWIN GADGETS" to show you just exactly what test to make and what remedy to use for OVER 400 Common Receiver Troubles. Each gadget is a pocket-sized pack of die-cut cards, eyeleted together and arranged for instant reference for any trouble symptom.

Ghirardi's
TWIN "TROUBLE SHOOTERS"
worth weeks of pay!

They'll earn their "keep" over and over again. Save you hours of fiddling and fussing. Just the flip of a card and there's your answer instantly—plain as the nose on your face. Easiest and handiest little service aids you ever saw. Full directions on each. (Nothing like them ever before—both brand-new! One for HOME-RADIO sets, one for AUTO-RADIO sets—you need 'em both—to keep in your pocket and use on every service call. Only 50c each (60c foreign)—**GUARANTEED** at that! So here's what to do this very minute to get your Gadgets—Clip a dollar to this ad, write your name and address on it and mail to:

RADIO & TECHNICAL PUB. CO.,
Dept. RN-117, 45 Astor Place, New York
Money Back Guarantee

MAIL NOW!
\$1 FOR THE PAIR

RADIOS.. SAVE UP TO 50%

DEAL DIRECT... FACTORY PRICES! Many models to select from: AC-DC; All-Wave; armchair models; automatic tuning; car radios; Farmsets that operate like city radios! Send postcard for NEW Bargain Catalog FREE. 30-DAY TRIAL plan and agent-user proposition!

GOLDENTONE RADIO CO.,
DEPT. A11, DEARBORN, MICHIGAN

Free Catalog

30 DAY TRIAL
\$6.98 UP

dozen relays, crystal ovens, and abbreviated Strouger relays, not to mention the bridge telephone, direction finder and other odds and ends. Who said you didn't have to study to keep up to date?

With an increased personnel the FCC is getting around to check up on the boys and their watch periods, etc . . . How times do change! 10 and 15 years ago the radiop could write up a log in 30 minutes (at his leisure) for a round trip from New York to Cuba. Now it takes pages and pages, just one entry after another. Not much chance for a "corking off" period or a dashing attempt at a history-making novel . . . Wonder how an op feels when the auto-alarm goes off about 0200 GMT and he rushes into the shack all excited just to find a blown fuse, high generator voltage or just plain static? Guess it takes plenty of ingenuity to use the ship's receiver for broadcast purposes while the auto-alarm is on . . .

There is still quite a bit of union trouble on both coasts. Radiops and other tried a few strikes in Boston, Philly, Baltimore, Norfolk and in Gulf Ports but with varying success. The CTU Mardiv have aligned themselves with the Masters, Mates and Pilots, and Engineers and Longshoremen associations and seem to be doing a rushing business of organization work at their offices in New York. We hear from DF who rises to remark: "How's a radiop in the tropics to stand an 8-hour watch in a radio room with 10 to 12-amps of juice going through charging units that keep the emergency batteries up to snuff, the auto-batts performing and the receiver-batts high? Kinda handy in winter though, huh? Well, this being hurricane season in the Indies, guess would be best to sign off, put on the cans, sit back and listen to the whistle of the tube, the sputter of the arc and the whine of the spark that soon will be no more—and another chapter in history is made and the radiops had a hand in its making."

It looks like plenty of competition has developed within the radio broadcast field now that the International Alliance of Theatrical & Stage Engineers have definitely decided to organize the broadcast ops and technicians. This IATSE is an AFL affiliate and as such is interfering with the IBEW (or has the IBEW quit organizing these wayward brethren since we went to press?). Nevertheless, the IATSE will do a real job of signing the ops on the dotted line now that they have gone on record. This organization is one of the strongest and oldest affiliates of the AF of L and has powerful connections in the Motion Picture, Theatrical and Broadcast industries. So it seems like the ops are going to be organized whether they want to or not. What with four organizations in the field, there's sure to be some tall organizing done! What's happened to the Airways ops? Or are they still orphans of the storm?

Occasionally one hears an oldtimer on 600 meters ask "Who was that fone station testing on ships bands?" The way things are moving it isn't far fetched to imagine an office boy in a New York city skyscraper office calling up a skipper anchored off Barnegat in a fog and demanding to know whyinell he doesn't proceed . . . or why the Chief Engineer is only turning 75 revs. in a heavy sea. Think that's bad? Well, just wait until television comes through, Hi. Then comes the revolution! And so with that to chew on until next time, we'll sign off . . . ge . . . 73 . . . GY.

NEXT MONTH

An Article on "J" antennas by A. J. Haynes contains much needed data.

JOBS are offering Good Pay in Radio & Aviation-Radio



"I am now a special radio operator with one of the country's leading air lines, which is the best job I ever had. I owe all of this to your training."
George Osborne, Kansas City, Mo.

"I already had a good job in radio, but since completing your training my salary has doubled."
Stanley McKnight, Camden, N. J.

"Thanks to your training and help, I am getting along fine on my first job in radio."
Rollie Terrill, Dallas, Texas.

Men with foresight are turning attention to the thrilling careers now offered in Radio and Aviation-Radio, and are fitting themselves for the glamorous future opportunities in Television. Trained radio men are in demand—at good pay. And now you can get the practical training needed, with real apparatus for conducting experiments in your own home, followed by four weeks' intensive training in our big modern laboratories. (Ours is the only independent school with modern 441-line electronic television equipment.)

Anyone 17 years of age or older with average ability and real ambition can qualify—for Midland makes progress simple by step-by-step experiments and "Color-Coded" lessons. Graduates are fitted to take exams for two Government Licenses and qualified to step into splendid-paying jobs in 50 to 60 different lines of work. Lifetime employment service. This may be your future. Investigate. Send for our big illustrated FREE BOOK.

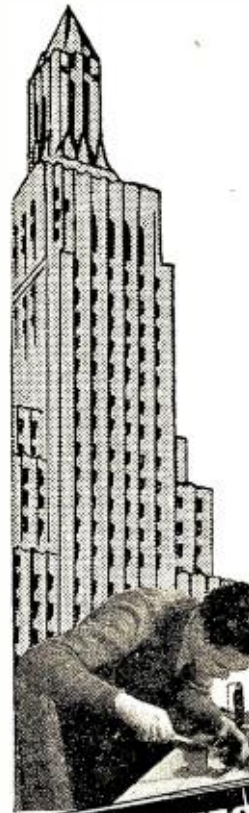

MIDLAND'S GREAT "Color-Coded" EXTENSION TRAINING in RADIO-TELEVISION

Under this new, improved method, devised by practical engineers in the Radio, Aviation-Radio and Television fields, you first learn the fundamentals by conducting experiments in your own home. Then we send you a bus ticket to come to Kansas City for your postgraduate training in our fine new school with its thousands of dollars worth of modern equipment.

We Furnish Equipment and Tools

You get 90 modern, Color-Coded lessons, 10 big shipments of equipment (to own and keep) including 3-inch Cathode Ray tube, all tools necessary, and 10 attractive "Home Laboratory" manuals.

MIDLAND TELEVISION, INC.

Frs. 29, 30, 31, Kansas City Power & Light Bldg., Kansas City, Mo. Sponsored by 5000-watt Columbia basic network Station KMBC



FREE—Send at once for this big illustrated book that will give you all the facts.

MAIL COUPON FOR FREE BOOK

MIDLAND TELEVISION, INC., Kansas City Power & Light Bldg., 110-L W. 14th St., Kansas City, Mo.

Without obligating me, send your FREE BOOK on Radio-Television opportunities—"FORTUNES IN FORESIGHT."

Name _____ Age _____
Address _____
City _____ State _____

FASTEST WAY TO LEARN CODE

Easy, Fascinating, LEARN by EAR To Be a GOOD OP.



The New All Electric Master Teleplex Code Teaching Machine is exactly what thousands are looking for. No experience needed. Ideal for beginners—steps up WPM for ALL Ops. There is no guess work with Master Teleplex, because it records your sending in visible dots and dashes. You SEE and HEAR exactly how you are making your signals. You learn code the way you'll be using it—by SOUND. Complete course included at no extra charge. Used by many schools and several governments for teaching code. Low cost; easy terms. MONEY BACK GUARANTEE. Send now for booklet RN11, no obligation. Post card will do.

TELEPLEX CO.

72-76 Cortlandt St. New York, N. Y.

Bud's the best! PROVED BY test!



Every BUD Product before being approved by the engineering department, is put through a life test calling for thousands of hours of laboratory-simulated operating conditions. BUD Products can "take it!" BUD sells for less, too! Today! Send for catalog N-1138 listing all BUD Products. FREE!

BUD RADIO, INC. 5205 Cedar Ave., Cleveland, O.

BUD RADIO, INC. CLEVELAND, OHIO., U. S. A.



WEBSTER-CHICAGO
Develops Another
Big "Sound"
MONEY MAKER



Model FC-7R
Size 9" x 7 3/4" x 6"

**SELECTIVE PAGING
SYSTEM WITH
TALK-BACK
FEATURES**

- 7 Watts of Power
- Talk to Any Station or to All Stations
- Talk Back From Remote Position Thru Speaker

**At Unbelievably
Low Prices**

Again Webster-Chicago blaze the trail of Sound Progress . . . opening a vast new market for the Sound Dealer. Previously a paging or call system consisted of an amplifier, microphone and the required number of speaker stations. Now for smaller factories, hotels, auto stations, Departmental installations in larger factories, in fact for any paging system covering up to 20 to 3000 sq. ft. of floor space. . . . A new low priced design having in addition a selective switch so that the operator can talk to any one station only or can throw the switch so as to talk to all stations at once. Talk-Back from positions of 20 to 40 feet can be done from each station. And in doing this, equipment has been greatly simplified; just one small master unit encloses microphone and necessary speech amplification equipment and one specially designed speaker for each station. (Transmitter as shown will handle up to 5 stations).

Example of Low Prices
Model FC-7R, \$70⁰⁰
List
Model DA-8, \$20²⁵
List



Model DA-8
Double End Speaker

WEBSTER-CHICAGO

The Complete Line of Public Address Systems, Sound Equipment and Accessories Popular-Priced Leaders in the Sound Field For Over 12 Years!

Strict Dealer Policy Fully Licensed

WEBSTER-CHICAGO
Section N-6, 5622 Bloomingdale Ave., Chicago, Ill.
 Please send me more information on Model FC-7R. Model DA-8 Speaker.
 Send Catalog.

Name
Address
City State



THE TECHNICAL REVIEW

CONDUCTED BY THE TECHNICAL EDITOR

Radio Stars of Today, by R. Eichberg, L. C. Page & Co., 1937. This book was written for the average listener who likes to know more about his favorite radio stars and about radio in general. Beginning with the Aces and ending with Walter Winchell it contains short descriptions of the lives of the most popular stars. In addition some chapters describe what happens behind the scenes in radio stations. Many excellent photographs illustrate the text.

Home-Radio Pocket Trouble Shooter "Gadget" and Auto-Radio Pocket Trouble Shooter, by A. A. Ghirardi, Radio and Technical Publishing Co., 1937. These are two sets of cards riveted together at one corner. They are so arranged that the serviceman can easily turn to any one symptom such as "dead" receiver, weak, hum, noise, etc. and find the possible causes of trouble in different parts of the receiver. Remedies for each instance are also indicated. This is an improved and enlarged edition compared to an old "gadget" prepared by the same writer.

Radio Engineering, by F. E. Terman, Second Edition, McGraw-Hill Book Co., 1937. A text book written for college students and others. This 813 page book differs from other text books in the treatment which avoids long mathematical derivations and gives many approximate equations of simpler form. According to the preface, it carries the analysis much deeper than customary. Professor Terman has originated some new, helpful ways of treating certain subjects. His universal resonance curve which can be applied to any r.f. amplifier stage through the concept of "effective Q" is just one illustration. Other subjects which have been unusually well covered are power supply filters, resistance coupled and transformer coupled amplifiers, power amplifiers, modulators, diode detectors, and the subject of wave propagation. The second edition differs from the first by a considerable addition of new material while the chapter on measurements was dropped.

References to original writings are given and problems appear now and then whereby the reader can test his knowledge. Chapter headings are: I. The Elements of a System of Radio Communication. II. Circuit Constants. III. Properties of Resonant Circuits. IV. Fundamental Properties of Vacuum Tubes. V. Vacuum-Tube Amplifiers. VI. Vacuum-Tube Amplifiers. VII. Power Amplifiers. VIII. Vacuum-Tube Oscillators. IX. Modulation. X. Vacuum-Tube Detectors. XI. Sources of Power for Operating Vacuum Tubes. XII. Radio Transmitters. XIII. Radio Receivers. XIV. Propagation of Waves. XV. Antennas. XVI. Radio Aids to Navigation. XVII.

Television. XVIII. Sound and Sound Equipment.

Jones' Ultra-High-Frequency Handbook, 1937 edition, by Frank C. Jones, Radio Ltd., 1937. A 64-page booklet on radio communication on waves below 10 meters. The text contains some theoretical considerations of ultra-short-waves, super-regeneration, special oscillators, etc., then describes several transmitters and receivers giving constructional information. The last two chapters deal with the different types of antennas suitable for ultra-high-frequencies and with directive antennas.

Review of Articles in the Proceedings of the Institute of Radio Engineers for August 1937

Theoretical Limitations of Cathode-Ray Tubes, by David B. Langmuir. This paper gives an equation for the maximum current density in a focused beam of cathode rays. Spherical aberration is also discussed.

An Oscillograph for Television Development, by A. C. Stocker. Description of a nine inch oscilloscope with amplifiers having a constant response from twenty cycles to two megacycles. Circuits and constants are given.

Development of the Projection Kinescope, by V. K. Zworykin and W. H. Painter. This paper discusses the general requirements and design of Kinescope tubes for projecting television images. A picture 18 x 24 inches in size having a brightness in the high lights of 0.9 candle per square foot appears to be an acceptable minimum for home television reception.

Review of Contemporary Literature

THE following are reviews of articles appearing in recent issues of technical magazines; the name of the magazine and its date are given after the title of each article. Copies of these articles are not included under the "Free Booklets"—they are available from your book-dealer or direct from the publishers. Addresses of publishers will be furnished on request.

Relays in Tube Output Circuits, by E. E. George, Electronics, August 1937. Presenting several charts so arranged that the relay charts super-imposed on tube characteristics will show circuit conditions for optimum magnetomotive force.

Video Amplifier Design, by R. L. Freeman and J. D. Schantz, Electronics, August 1937. Data on design of a wide band amplifier for picture signals with special efforts to reduce phase distortion and improve transient response.

Inverse Feed-Back, by B. D. H. Tellegen

and V. Cohen Henriquez, Wireless Engineer, August 1937. Another discussion of the subject paying special attention to correction for the varying voice coil impedance.

An Electronic Volume Compressor, by R. B. Bullock and Harry N. Jacobs, QST, September 1937. A system of "a.v.c." for the speech amplifier which allows a high average of modulation percentage without fear of over-modulation.

Extension of Normal-Incidence Ionosphere Measurements to Oblique-Incidence Radio Transmission, by N. Smith, National Bureau of Standards Research Paper RP1013. A simple rapid graphical method is given for obtaining skip distances and limiting frequencies for radio waves, from normal-incidence measurements.

Navigation with Loop Antennas, by H. W. Roberts, Aero Digest, September 1937. The various systems of directional reception viewed from the standpoint of the aviator.

Experiments with Underground Ultra-High-Frequency Antenna for Airplane Landing Beam, by H. Diamond and F. W. Dunmore, National Bureau of Standards Research Paper RP1006. Placing the antenna underground in the center of the landing field permits a steeper approach of the airplanes and allows greater flexibility to meet varying wind conditions.

Transmission Lines at Very High Radio Frequencies, by L. E. Reukema, Electrical Engineering, August 1937. Radiation resistance is a factor affecting the Q of a tuned transmission line. Taking this into consideration, the design equations for both concentric and parallel wire lines are revised.

Small-Vessel Direction Finders, by H. B. Martin, RCA Review, July 1937. Describing the available equipment and its working principles, including methods of balancing the loop.

(Turn to page 319)

The Radio Voter

(Continued from page 269)

transmitted and the Radiovoter will react automatically if it is tuned to the station sending it out. This adds a small power load to the current used by the receiver and the mass effect of great numbers of sets so responding to the tone signal can be noticed on the master meters of co-operating power companies. The Radiovoter step-up in power consumption, according to the designers, can be broken down mathematically to determine a virtually exact number of sets tuned in. Direct voting can be accomplished when the listener presses a button and the number of "ayes" and "nays" is determined in a similar manner.

The inventor claims that the Radiovoter is foolproof and that no outside interference can affect the actual "vote." He says that stuffing of the ballot box in any Radiovoter straw poll is impossible.

One of the problems involved in distribution of the devices is "Who will pay for the service?" Eventually, it is expected by the designers, that all leading manufacturers will make the Radiovoter standard equipment in receiving sets. It is debatable, though, whether the device is of most advantage to the listener or the sponsor. Its application would enable sponsors to measure their audiences and determine listener reaction and, likewise the National Electric Ballots executives declare, the listener will have the advantage of having his opinion registered and thus get the type of programs he desires.

QUALITY Proven by actual PERFORMANCE



... in the field year after year Radio Service Specialists have proven the consistent superiority of National Union Tubes. It's this kind of testimony from the boys on the firing line that really counts. When a National Union tube goes into a socket the man who puts it there has full confidence that he's used the finest product tube-making science can provide

FREE SERVICE EQUIPMENT!

Free Equipment

Let N. U. equip your service shop free with your pick of the latest and best radio testers. Free equipment includes: Tube testers, set analyzers, oscillographs, signal generators, modulators, meters and other servicing instruments. In shop equipment items available include stock cabinets, coats, display signs, electric clocks, etc. All items absolutely free the National Union Way.

The National Union Way

Through National Union's help, radio service dealers everywhere have been able to set up better equipped shops to do better work; also to obtain sales helps that produce more customers. National Union has constantly put the latest advances in scientific equipment as well as modern selling aids within reach of the service dealer. The National Union Deal calls for a dealer deposit which is rebated when the specified number of tubes have been purchased. Over 70,000 completed deals. Every dealer should investigate.

NATIONAL UNION THE ROAD TO BETTER BUSINESS

1. Full guarantee on highest quality radio tubes.
2. Cut price business not solicited.
3. Price Protection.
4. N. U. jobber stocks are complete... No hunting for odd types.
5. Timely business building aids.

National Union Radio Corporation
570 Lexington Avenue, New York City RN-1137

I am interested in the following equipment:

Name.....

Address.....

City..... State.....

1938 Radio Data Book Free! (see Page 319)

FREE BOOK of Opportunity
Instructive facts about
TELEVISION
RADIO
SOUND RECORDING

Complete, practical instruction. Earn room and board while learning. Coach railroad fare allowed to Los Angeles.

NATIONAL SCHOOLS

MAIL COUPON FREE BOOK

National Schools, Dept. 11-RN,
4000 So. Figueroa St., Los Angeles, Calif.

NAME..... AGE.....

ADDRESS.....

CITY..... STATE.....

HANDEE
Tool of 100 Uses

A whole shop full of tools in one. Does away with slow hand work. Plugs in any light socket AC or DC, 110 v 13,000 r.p.m. Uses 200 different accessories—grinds, polishes, routs, drills, cuts, carves, sands, saws, sharpens, engraves

Get A Demonstration
at Hardware, Dept. Stores, Tool Dealers or order on 10 Day Money-Back Trial. \$10.75 and up postpaid. 3 Accessories Free. DeLuxe Model \$18.50, with 6 Accessories. Catalog Free.

CHICAGO WHEEL & MFG. CO., 1101 W. Monroe, Dept. AB, Chicago

New CRAFTSMAN Project Book
Pleasure and Profit with a Handee. Easy working plans for making many interesting and unusual projects 25c, stamps or coin.

For Faster Better Jobs

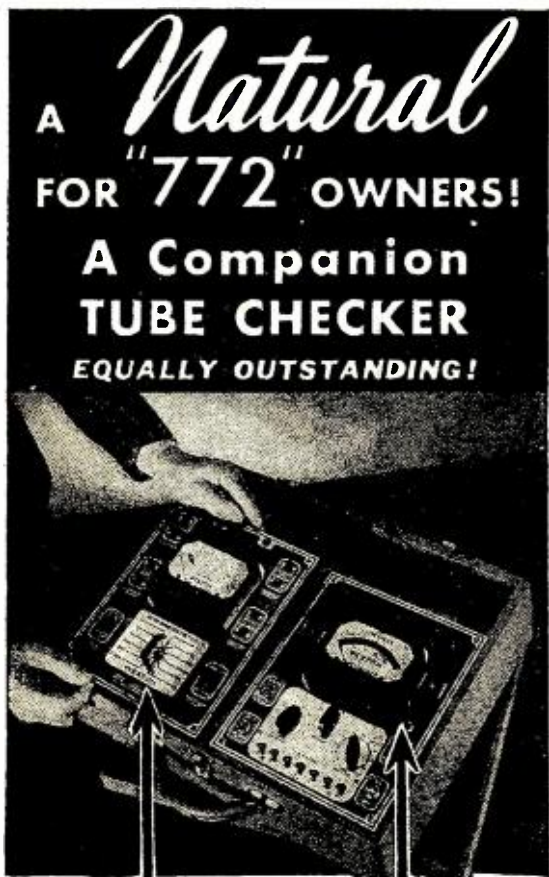

Your Model "772"
fits here - in this lightweight, solid-wood combination carrying case with real luggage handle... along with -

This New Model "773"
Tube Checker... which matches your "772"... giving you a complete, modern, servicing combination.

Simply mount your Model "772" Analyzer in this handsome, combination carrying case along with the matched Model "773" Tube Checker, and you have the most modern, up-to-the-minute servicing unit available. Model "773" represents the last word in tube checkers... in design... in operating characteristics... in simplicity and dependability! But if you don't own Model "772"... purchase the *complete* unit (Model "775" SERVISSET). Be set for better business in the active season ahead... be able to service sound movies, P.A. systems, electronic circuits and television, as well as all receivers. Have a servicing unit that will enable you to get the profits from *all* these sources, and one that will remain serviceable and dependable for years to come. Be sure to get complete information. Return coupon.

Remember...

WESTON
Instruments

can be purchased under the
WESTON INVESTMENT PLAN.

Weston Electrical Instrument Corporation
615 Frelinghuysen Avenue, Newark, New Jersey.
Send data on Models 773, and 775 combination.

Name _____
Address _____
City _____ State _____

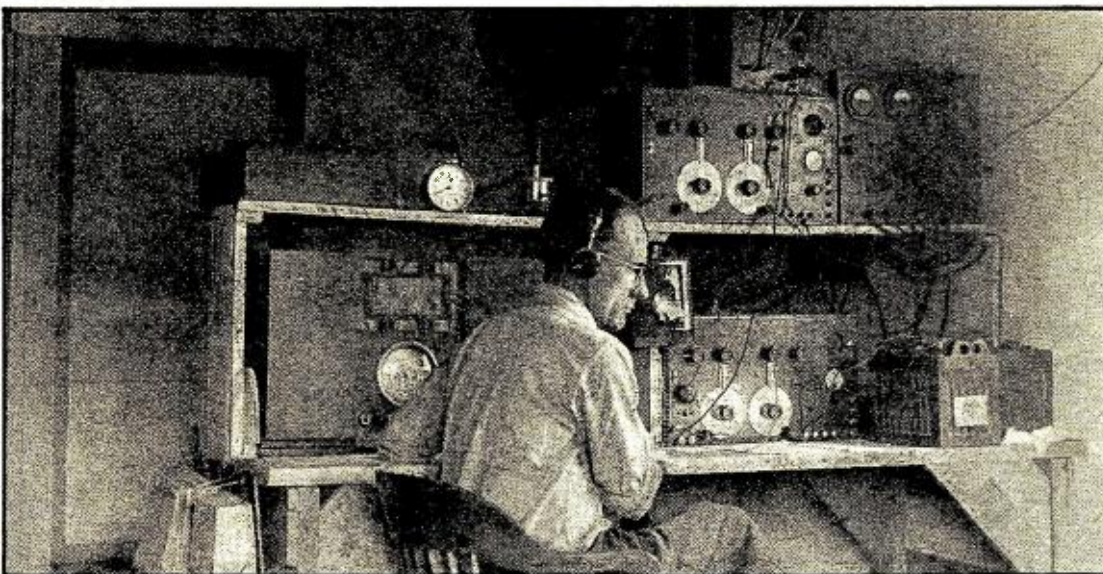

THE AMATEUR OBSERVER

Conducted by W2JCR

THIS department made its bow to RADIO NEWS readers only two months ago, at which time an invitation was extended to those interested to apply for appointment as Official RADIO NEWS Amateur Band Observers. In this relatively short time a surprising number of applications have been received. Of this number forty appointments have been made, as listed on this page.

* * *

AMONG the unsuccessful applicants many failed to include a list of amateur stations recently heard and therefore, of course, provided insufficient basis for judging their qualifications for appointment. It is suggested that all those who have failed of appointment so far submit monthly lists of stations heard during the next two or three months.

* * *

Additional applications are invited from all readers who make a practice of listening for amateur DX. Readers in foreign countries are especially welcome as publications of their regular monthly lists of calls heard is naturally of outstanding interest to American amateur station operators, most of whom are particularly anxious to know whether their signals are being heard in foreign countries.

* * *

In submitting lists of stations heard Observers and applicants are urged to list only DX stations. The definition "DX" will, of course, vary with the different amateur bands. On 20-meters, for instance, nothing can be considered as DX reception at distances under about 3000 miles. It is impossible to lay down any hard and fast rule covering the individual bands and individual receiving locations so each one reporting will have to judge for himself as to just where the dividing line falls.

* * *

To date few lists of 5-meter stations have been received. It is hoped that this condition will be corrected and Observers who are equipped to listen on this band are urged to send in lists of stations heard. It is believed that in the present state of development of this band, stations more than 30 miles distant may be considered DX.

* * *

Photographs of ham stations or of amateur band listening posts will be most

Official RADIO NEWS Amateur Band Listening Post Observers

United States

- California: G. C. Gallagher, W. Hallgren, Harry Honda
- Colorado: M. J. Markuson
- Connecticut: George L. Jones
- District of Columbia: Charles J. Havlena
- Illinois: Rodney Newkirk, Robert Lee Nichols
- Indiana: Garland Haas
- Louisiana: Wilbur T. Golson
- Maine: H. Francis Shea
- Missouri: Raymond W. Sahlbach
- New Jersey: Nelson Lecklikner, Ray Service, Paul Wunsch, Jr.
- New York: Elmer R. Fuller, L. F. Gallagher, Julian D. Hirsch, Michael Kelly, Roger Legge, Jr.
- North Carolina: William W. Oglesby, Jr.
- Ohio: Wilbur Croston
- Oklahoma: Hugh Robinson
- Oregon: Herbert A. Gilbaugh
- Pennsylvania: Albert Augustine, Clarence Hartzell, Thomas P. Jordan, Ernest Pavlidis
- Texas: Bill Sloan
- Vermont: E. H. Davenport
- Virginia: Robert Hatcher, Chris Davis Jaffe
- Wisconsin: Ray Bayer

Foreign

- Australia: Frank E. Taylor
- Canada: Bernard J. Clancy
- England: J. S. Dunn, E. J. Margrie, N. C. Smith
- New Zealand: J. C. Sibbin
- Poland: P. Piorko

welcome for publication in this department. If you have a good photograph of your set-up, won't you send it along so that others can see your equipment.

Calls Heard

By W2JCR (Portable), S. Gordon Taylor, Fairfield Beach, Fairfield, Conn.
5 meters ("Quartet" Superheterodyne): W1BCR-9, W1ZE-6, W1DEI-8, W1GCA ? (in QSO with W1JLQ-8/16/37), W1JQ-7 (Portable-Mobile, Mt. Wilburham, Mass.), W1BJE, W1GDJ-7, W1MY-7, W1JLK-7, W1FLO-7, W1KAT-8, W1IJ, W2HGH-8, W2JCY-9, W2KBS, W2COT-8, W2KDB-6, W2KBH-7, W2DBS-7, W2IDV-8, W2HZV-8, W2AYR-7, W2IZR-6, W2JRG-7, W2GPS-6, W2DB-7,

HAM RADIO IN THE ARCTIC
K7FVV, the amateur station of George Rayburn at Wiseman, Alaska, 100 miles north of the Arctic Circle, provides the link between this tiny settlement and the outside world.

FLASH! FLASH!

CECIL MELLANBY, Pwllheli, Wales, heard the Australian 5-meter phone station VK2NO from 4:20-4:45 P.M. (Sydney, Australia, time) on November 22, 1936. He submitted a report to VK2NO and has just received written verification in which it is stated that Observer Mellanby's report checks 100 percent with the log of VK2NO who at the time was in a QSO with VK2HL.

The 5-meter transmitter at VK2NO is an MOPA rig with a 6L6 E.C. oscillator doubling from 10 to 5 with an RK25 buffer which drives a pair of Eimac 35T's in push-pull with up to 150 watts input. The antenna is a Reinartz rotary beam, pointed northwest.

Observer Mellanby has heard quite a number of foreign stations on 5-meters at distances over 3000 miles but this confirmed reception of 5-meter signals, almost half way around the world, is certainly an achievement even for him.

W2EJP-6, W2EKI, W2JHV-8, W2MO-9, W2IRY-7, W2KKT-9 (Portable-Mobile, New Haven, Conn.), W3GLF-7, W3DZD-6.

By W2JCY, Laurence M. Cockaday, North Pelham, N. Y.

5 meters ("Quartet" Superheterodyne): W1JOA-7, W1BJE-5, W1DEI-8, W1ZE-9, W1TIS-7, W1KNM-8, W1KAT-8, W1EYM-9, W1JRN, W1KSD-9, W1JPM, W1CDR-9, W1KOK-9, W1MY-6, W1DA-6, W1IXP-7, W1EST-7, W1AVV-9, W1IJ-9, W1KEG-5, W1GDJ-9, W1FKV-8, W1JZA-6, W1BCR-9, W1KFL-5, W1JQ-8, W3CXP-4, W3DZD-9, W3CNI-9, W3GLF-9, W3EZN-9, W3ANR-9, W3FBH-9, W3AUY-9, W3GRM-6, W3GJU-7, W3COJ-8, W3AFJ-8, W3MV-6, W3DZR-8, W3FLY-6, W3DBC-7, W3GOK-7, W3EUY-8, W3EET-8, W3GIO-4, WSHJP-8, W8FZE-9, W9VAQ, W9CLH.

10 meters: T12RC-S, HK1JD-9, G5QY-7, G6ML-5, G6QY-7, LU5AN, LU9BV-9, K5AT-9, K5AG-9, HR4AF-9, ZS1C-5, ZS6AJ-6, ZU6P-7, NE1AG-9, XE1AN-9, XE1A-9, XE1GE-9, XE3AR, K6MVV-9, K6OQE-9, K6LCV-9, PY2AC-8, HP1A-9, K4EJG-9, K4EJF-8, FMSAA-3, TGA7, J3JF-4, ZL2FY-8, ZL2CI-7, VE4GD-9, VE4EO, VE4AW-9, VE4LX-7, VE5FY-9, VE5HR, D3AUK-8, D3CSC-5, D4GDF-8, YL2CD-7, OA4J-9, ZE1JB-7, FSEF-6.

By Jesse Hathorn, Jr., 936 Samuel Street, Louisville, Ky.

20-meter phone: CE1AO, CE1CH, CE3DW, HK3Z, HK3JA, HK3BG, HC1FG, LU1QA, LU1DA, LU1J, LU4BH, LU5CZ, LU6AP, LU7AC, OA4N, OA4R, OA4AG, OA4FI, PY2EP, PY2ER, PY2LJ, THAS, T12RC, T12KP, T12LR, T12PG, VP3BG, VP5PZ, XE1LK, XE1FE, XE1SY, XE2SY, XE2AH, NE3AR, W1OXDA, G5ML, YN1HS, K4SA.

By Elmer R. Fuller, 29 Pearne Avenue, Cortland, N. Y.

20-meter phone: W6CKQ-7, W6ISH-6, W6KOP-8, W6LLO-7, W6XI-7, K6NZO-7.

160-meter phone: W8QAV-6, W8LSL-7, W8FEJ-9, W8OHB-7, W8RTL-6, W9VRV-7.

By Claud H. Roberts, 30 Crogslan Road, Chalk Farm, London, England

20-meter phone: W1AXA, W1EH, W1ILO, W1BLO, W1HPV, W1GPE, W1W, W1APA, W1JUG, W2FWK, W2JOA, W2DH, W2JP, W2GO, W2BZ, W2FPB, W2IXY, W2IYO, W2GAU, W2ZC, W2AD, W2HED, W3ANH, W3MD, W3HS, W3FPU, W3XAY, W3DLL, W3AHS, W3BEI, W4CYU, W4DCR, W4CRA, W4XP, W9PBJ, LU5AN, LU6KE, PY2FF, H3K, YV5AE, ZP2AK, VE1JA, VE1LR, VE1BR, VE1CI, CO2WZ.

By W1KKY, George L. Jones, Shaker Road, R. F. D., Hazardville, Conn.

20-meter phone: G2PX-5, G5NI-7, G6BW-6, G6DT-5, G6XR-4, FSDI-5, CT1AY-4, OQ5AA-4, EI2J-5, HK4AG-7, YV5ABE-5.

By Thomas P. Jordan, 1523 N. Main Avenue, Scranton, Pa.

10 meters: W5GAR-4.5, W4EGH-5, W4GB-5, W9VMY-5, W9POS-5, W9AC-5, W9BB-5.

20 meters: CX2AK-8, CE1AR-8, VP1AA-7, VP5AF-7, G2CU-6, G6NI-7, OA4N-7, EASAE-8-9.

By Clarence Hartzell, 1 N. 6th Street, Overbrook, Jeannette, Pa.

10 meters: W4CRF-8, W6MAT-5, W6CJR-3, W6GC-4, W6NMI-3, W6MWO-4, W6OQN-5.

(Turn to page 320)

14 tube "COMMUNICATIONS" RECEIVER
Five Bands 60 Mc.-540 Kc. (5-555 Meters)

COMPLETE COIL KIT CONSISTS OF: 1—Completely wired tuning unit consisting of Multi-Wave Coil Assembly, Wave Change Switch, Variable Condenser, Tube Sockets for tuning circuit, and Calibrated 8 inch two-speed dial with band spread. 1—Noise Silencer Transformer. 1—Beat Frequency Oscillator Transformer. 1—Matched Pair of Crystal Filter Transformers. 1—Crystal Phasing Variable Condenser. 1—FERROCART (iron-core) I.F. Output Trans. 1—FERROCART (iron-core) Band Expansion I.F. 1—A.V.C. Transformer. 5—Shielded R.F. Chokes. Complete set of diagrams and instruction sheets. Kit No. 7502—Complete as described above.

Drilled and Punched Chassis—Finished in Black Crackle—Size 17" x 13" x 3" Chassis No. 18282.....List \$5.50

53.50 LIST

MEISSNER MFG. CO.
Mt. Carmel Illinois

Just Out! 1938 Radio Data Book! (see Page 319)

A-B-C SHORTHAND
IN TWELVE \$1.00
easy LESSONS

A-B-C SHORTHAND is a scientific method of speech shortening. It is written with the familiar A-B-C's, no puzzling signs or symbols to memorize. You acquire such speed in 12 lessons as writers of other systems seldom acquire after months of tedious practice. Writers, students, lecturers—here is an exceptional opportunity to learn shorthand in 12 lessons.

By all means investigate the A-B-C Shorthand System. It is so simple, so easy to learn that you will find yourself actually writing shorthand after a few hours of study.

Send \$1.00 to Teck Book Co., 461 8th Ave., New York.

TRIMM
FEATHER-
WEIGHTS

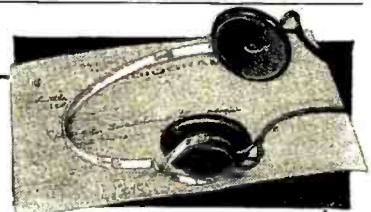

CAN TAKE IT!

Extreme heat or cold
Excessive humidity
Direct current
Rough usage

TRIMM RADIO MFG. CO.

1770 Berteau Ave., Dept. R-2, Chicago, Ill.

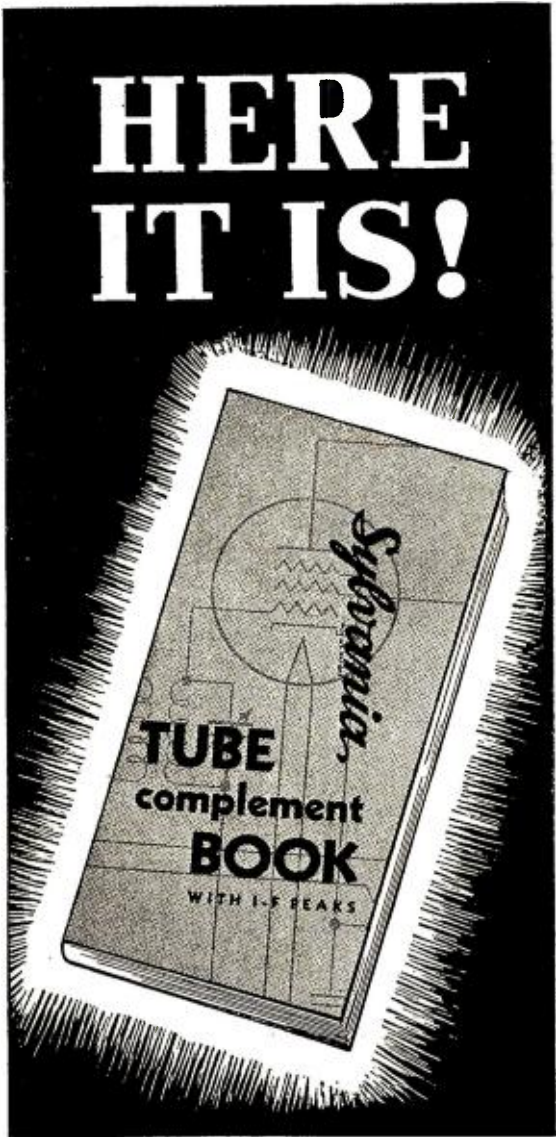

The Only Tube Complement Book Available!

This month we are glad to announce publication of a brand new service men's profit help—the new Sylvania Tube Complement Book! We think it will do the job it was designed for—tell at a glance the tube complement of any set you'll ever be called on to service. Look at what it contains, then judge for yourself:

In addition to tube complement listings for 10,386 models, the 168 page Sylvania Tube Complement book contains the most complete and largest compilation of i-f peaks available . . . helpful articles dealing with tube selling . . . names and addresses of all active radio receiver manufacturers . . . and many other big features too numerous to list.

This is the only tube complement book now available. So if you want your copy before the rush slows up delivery, mail the coupon and 25c now! Or see your jobber—he may be able to supply you.

SYLVANIA SET-TESTED RADIO TUBES

HYGRADE SYLVANIA CORP. RN-117
Emporium, Pa.

Enclosed please find 25c. Send me my copy of your new Tube Complement Book right away.

Name

Address

City State

Dealer Serviceman Amateur
 Experimenter

THE DX CORNER

(For Broadcast Waves)

S. GORDON TAYLOR

AFTER a two month "vacation" the Broadcast Band DX Corner again makes its appearance, coincident with the beginning of the 1937-8 DX season. During this season an attempt will be made in this Corner to provide a very complete monthly schedule of special DX broadcasts—not only those dedicated to Radio News, but all special programs that come to our attention. An invitation is hereby extended to Observers, clubs and all those having to do with special programs or special DX tips broadcasts, to send in information to help make these schedules as complete as possible. Any who submit such information please bear in mind that Radio News goes to press approximately thirty days before it makes its appearance on the newsstands. Notice of programs for a given month should therefore be in our hands by the first of the preceding month.

News From WJBO

WJBO has for some time been operating from its new station. The power is now 500 watts, a five-fold increase over last year, and the new frequency is 1120 kc. With this new power and the new vertical antenna which, incidentally, is the tallest structure in Louisiana and the second tallest in the entire South, it is expected that WJBO will have greatly increased coverage during the coming DX season. This should be of special interest to DX'ers because this station plans a series of special DX broadcasts this season which will be decidedly worthwhile from the standpoint of program value.

Through the courtesy and cooperation of Wilbur T. Golson, Chief Engineer of WJBO

AN IOWA DX'ER

Observer Kruse of Dubuque, Iowa, with his two DX receivers, a Brunswick cabinet model and a 5-tube home-made job. With this equipment he pulled in 561 stations on the Broadcast Band during the past season.

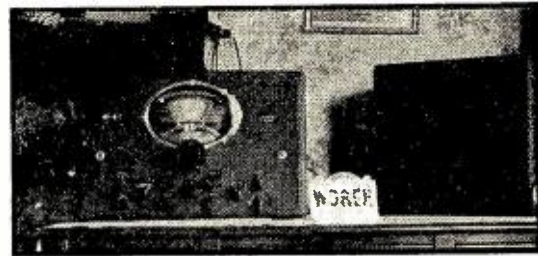

AND NOW FOR SOME DX!

Ray E. Everly, pioneer Observer, has equipped himself with this Patterson PR-15 receiver and expects to accomplish a lot in the way of DX during the coming season throughout its range of 550 kc. to 40 megacycles.

and Official RNLPO for Louisiana, WJBO's semi-monthly DX broadcasts throughout the coming season will be dedicated to Radio News Broadcast Band Listening Post Observers everywhere. Following are quotations from a letter recently received from Mr. Golson.

"The DX programs over this station will be put on the first and fourth Sunday mornings each month throughout the season beginning September 5. All will be dedicated to the Radio News Broadcast Band Observers. I will conduct the programs direct from the new transmitter building and many special features from remote points will be included. Again this year the Radio Club of Louisiana State University will provide the entertainment during the first hour of each of these special broadcasts. I have already secured several features, including the famous LSU band, the Tigar Quartet, the Radio Guild players and the Campus Dance bands. Mr. L. A. Rice, University Radio Engineer will be in charge of the broadcasts from remote points as he was last year.

"The second hour of each broadcast will be from the transmitter building and will include remote pick-ups from the Heidelberg Roof Garden and the news rooms of our newspaper the 'State Times and Morning Advocate.' DX report letters will be answered over the air just before the close of each broadcast at which time interference from other stations will be at a minimum. As stated, these WJBO special broadcasts will be 100 percent Radio News this season and will occur on the first and fourth Sunday mornings each month, 1:00-3:00 A.M., C.S.T."

On Sunday morning December 5, 1:00-3:00 A.M., C.S.T. the big Radio News show will be put on. If any Observers have material which they think will be of interest for use during this broadcast (or any of the other broadcasts over WJBO) it is hoped that they will forward it to Chief Engineer Golson in care of the station.

This cooperation from WJBO is very much appreciated and all listeners are urged to report on these programs, including in these reports all possible information on the signals that will be helpful to the engineers in judging the effectiveness of their new transmitter. We certainly owe a vote of thanks to Observer Golson for his fine work in not only dedicating these programs to Radio News Observers but in arranging for the entertainment features as well, and for the work and responsibility which he assumes in this connection. It is expected

that another Louisiana Observer, A. V. Deterly will assist with the DX tips broadcasts during these programs, for which he too rates a vote of thanks.

GCDXC Reorganized

Since last season the Globe Circlers DX Club, Inc., has been reorganized and new officers appointed as follows: Arthur J. Parfitt, President; James L. Black, Vice-President; Carl Eder, Secretary; Harry M. Gordon, Chairman of the Board of Directors; and Raphael Geller, Treasurer. The Board consists of 10 members beside the Chairman: John I. Vaught, Orville Brown, Max Demuling, Leo Herz, Floyd Murphy, Ken Albrecht, Sergio Gonzales, Bob Botzum, Walter Wallin and Harold Burstrom.

The club bulletin, the "Hot Spot," issued twice each month, includes BCB, SW and amateur sections. These bulletins report on receiving conditions over the country, list stations that do, and do not, verify, and include a QSL department for SWL card traders. Last but not least our articles "The Man Behind The Mike," written by station officials, engineers, etc., give you a glimpse of what the Broadcaster thinks of the DX situation of today. This is furnishing valuable hints of *what not to do* in reporting. It is agreed in DX circles that this is an ever-increasing problem, and we aim to do our share in clearing away the obstacles that make it so difficult for the CPC man to arrange special DX programs. The club has a copyrighted report form which is used by many members, and has brought much favorable comment from stations.

We invite all DX'ers to take advantage of our special trial membership offer which allows full club privileges and the official club bulletin for a trial period of 13 weeks, for the small sum of fifty cents. All remittances are to be mailed to the secretary, 1652 Radcliff Avenue, Bronx, New York, Carl Eder, Sec'y

Correspondents Wanted

I wish you would list my name in the correspondence column, stating that I will answer all letters from LPO's and any letter from a distance of more than 500 miles. Foreign hams and SWL's especially wanted.

(Observer) Jack Quintrell
445 Carmody Road
Seat Pleasant, Md.

I have just had some new SWL cards printed and I was wondering if you would be so kind as to put a small paragraph in the next issue of the "bible" to the effect that I would like to have DX'ers write to me. To anyone that drops me a line I will send my card. Anyone who sends me his picture will get one of mine, although what he would do with it I don't know—for I can't see what ye old mug's charm can do in any album, Hi!

(Observer) Stan Elcheshen
801 Literary Road
Cleveland, Ohio

NZDXRA

You will be interested to know that we have inaugurated a stamp Bureau, for members, so that N.Z. members now are able to purchase U.S.A. stamps instead of the International Reply Coupons, and we are accepting American stamps from new American members in payment of their subscription (65c per year). This will be much more convenient to American members.

E. C. M. Philpott, Sec'y
N.Z. DX Radio Association
127 Westminster Street
St. Albans, N. L.
Christchurch, New Zealand

NEWS FLASH!

Now THE FINEST RADIO ACTUALLY Costs Less!



Now—in the startling new McMurdo Silver "15-17"—the tremendous advantages of highest quality parts, craftsmanship, and individual custom building for each owner can be enjoyed by EVERYONE.

With the new "15-17" now ready, there is *no need* to longer endure an ordinary radio because of price. The *Only* radio that will out-perform the "15-17" is the 1938 MASTERPIECE VI, we guarantee this in our liberal home trial plan. All of the engineering skill, the outstanding quality and the brilliant performance of the Distinguished Family of MASTERPIECE is built into this popular priced super-fine receiver.

Yet it COSTS EVEN LESS than the regular production sets it will clearly out-perform in any test you wish to make. Get the PLUS value of a MASTERPIECE.

CHAMPIONSHIP SENSITIVITY

All bands between 1/2 and 1 microvolt absolute sensitivity, with no dead or weak spots in any of the four bands. Plus true MASTERPIECE shielding that means *usable* sensitivity for championship DX—the same thoroughbred response that caught 110 stations all over 6000 miles for Mr. Robert Rossi of Philadelphia to win the International Short Wave DX Club title of "Interplanetary Space Scout".

- New circuit • new r.f. amplifier • new i.f. amplifier • new tonal perfection • wave range 530 kc. to 11.5 meters *continuously* • 1/2 to 1 microvolt sensitivity • new quietness • tuned and amplified AVC • automatic tone balancing circuits • dual tone controls • 20 watts output • 15 inch GIANT speaker • 30 to 8000 cycles tone range • absolute stability • free-wheeling tuning • six feet of band spread on each wave band • beat oscillator • amplified "magic eye" • headphone jack • phono operation • hum free • MASTERPIECE construction and shielding thruout • anti-microphonic • polished chrome finished • highest quality parts • five year guaranteed.

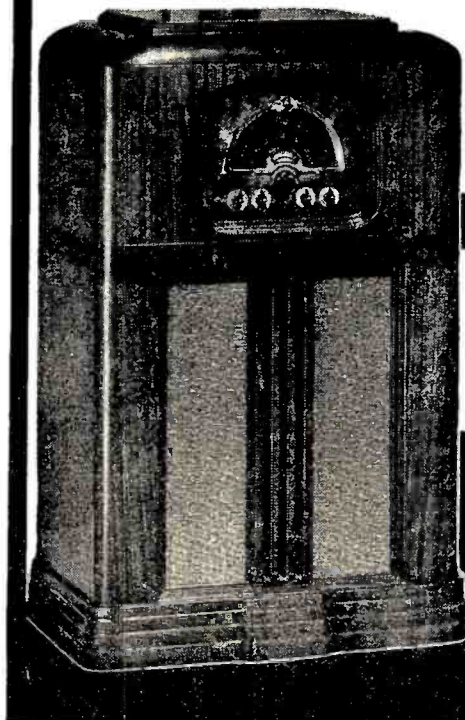

AMAZING VALUE!

NEW TRIPLE SELECTIVITY

At the flip of a knob you select hair splitting 4 kc. station separation, ease into broad 8 kc. tuning, or over to full range high-fidelity-control of every modern tuning need.

MAIL THIS COUPON NOW

McMURDO SILVER CORP.
2900A So. Michigan Blvd.
Chicago, U.S.A.

Send me full "15-17" details.

Name

Address

LOW PRICED! EASY TO ERECT! STEEL ANTENNA TOWER



60c FT.
F. E. B. Sioux City Iowa

HAMS!—Here's the ideal antenna tower—can also be used as a vertical radiator. Strong! Light weight! Extremely rigid! Comes in 20 ft. sections, with 5 ft. tip, knocked down, for building towers 25, 45, 65, 85, or 105 ft. high, as you wish. Easy to erect. Easy to climb.

Tower Legs—1/8" x 1-1/4" x 1-1/4" x 20 ft. Low carbon rail steel angle. Galvanized after fabrication.

Cross Bars—1/8" x 3/4" x 12-3/4" mild steel, spot welded to form X brace. Baked black enamel.

Bolts—1/4" USS x 3/4"—1085 steel, cadmium plated. **Guy Wire**—300 ft. No. 9 galvanized with each 20 ft. section. Tower weighs 4 1/2 lbs. per foot when assembled.

Order Direct From
WINCHARGER CORPORATION
Dept. RN-11 Sioux City, Iowa

SUCCESSFUL SERVICING

FOR PROFESSIONAL SERVICEMEN

Men looking toward the future, realize the importance of technical training, in understanding the problems that new, intricate equipment presents. RSI advanced home-study training in Radio Service and Public Address work is the "Key" to Successful Servicing.

Study At Home—Terms as Low as \$5 Mo. RSI gives you latest instruction on what goes into modern receivers, and basic knowledge of how complex circuits work. It familiarizes you with various types of vacuum tubes and how they operate... it helps you progress from the "mechanic" stage to that of an expert specialist. Send for book, "The Key to Successful Servicing."



WRITE TODAY FOR FREE BOOK

RADIO SERVICE INSTITUTE
Dept. RN11--3308 14th St., N. W.--Wash., D. C.

VALUE PLUS...
Elgin 800 Tube Tester

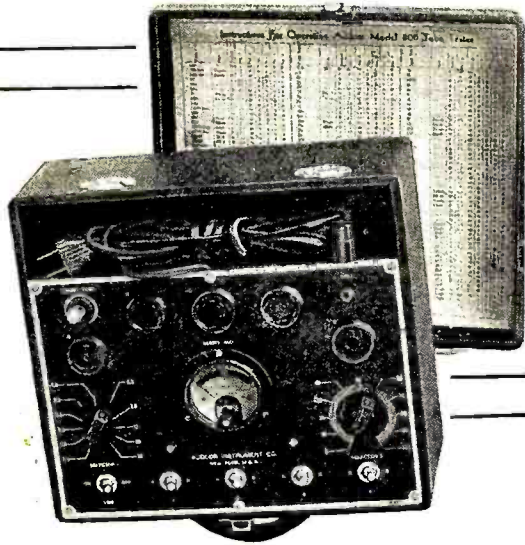

- Tests All Tubes Including Metal
- D'Arsonval Moving, Coil Meter
- English Reading "Good"- "Bad" Scale
- Separate Section Tests
- Accurate Tests on All Tubes
- Portable Leatherette Covered Case
- Compact—Can be Carried Anywhere
- Requires But Two Settings For Tests
- Combination Short Test and Meter Fuse
- Chart For Testing All Tubes

Complete Net Dealer's and Serviceman's Price..... **\$11.50**

MODEL 801 Volt-Ohmmeter

A sensitive, compact and accurate volt-ohmmeter that will be the busiest instrument in your "lab," or out on jobs. DC voltage readings -0-5-30-500 and 1000 - resistance readings from 1/2 to 500 and 200 to 500,000 ohms. Will read from 0 to 1 Ma. Low resistance range direct reading. Meter has 1000 ohm per volt sensitivity. Battery is self contained. Panel is clearly lettered. Compensator provided for zero adjustment. Measures only 3" x 3 1/4" x 2 1/2".



DEALER'S NET PRICE WITH BATTERY..... **\$5.75**
Send for circular describing our complete line.

TRY-MO RADIO CO., INC.
85N CORTLANDT ST., N. Y. C.

Ask your **JOBBER**
for the NEW
STANCOR
"HAMANUAL"
New Tubes... New Circuits
16 NEW TRANSMITTERS
5 WATTS TO 1000 WATTS
STANDARD TRANSFORMER CORPORATION
850 BLACKHAWK STREET, CHICAGO

RADIO ENGINEERING,

broadcasting, aviation and police radio, servicing, marine radio telegraphy and telephony, Morse telegraphy and railway accounting taught thoroughly. Engineering course of nine months duration equivalent to three years of college radio work. School established 1874. All expenses low. Catalog free.
Dodge's Institute, Oak St., Valparaiso, Indiana

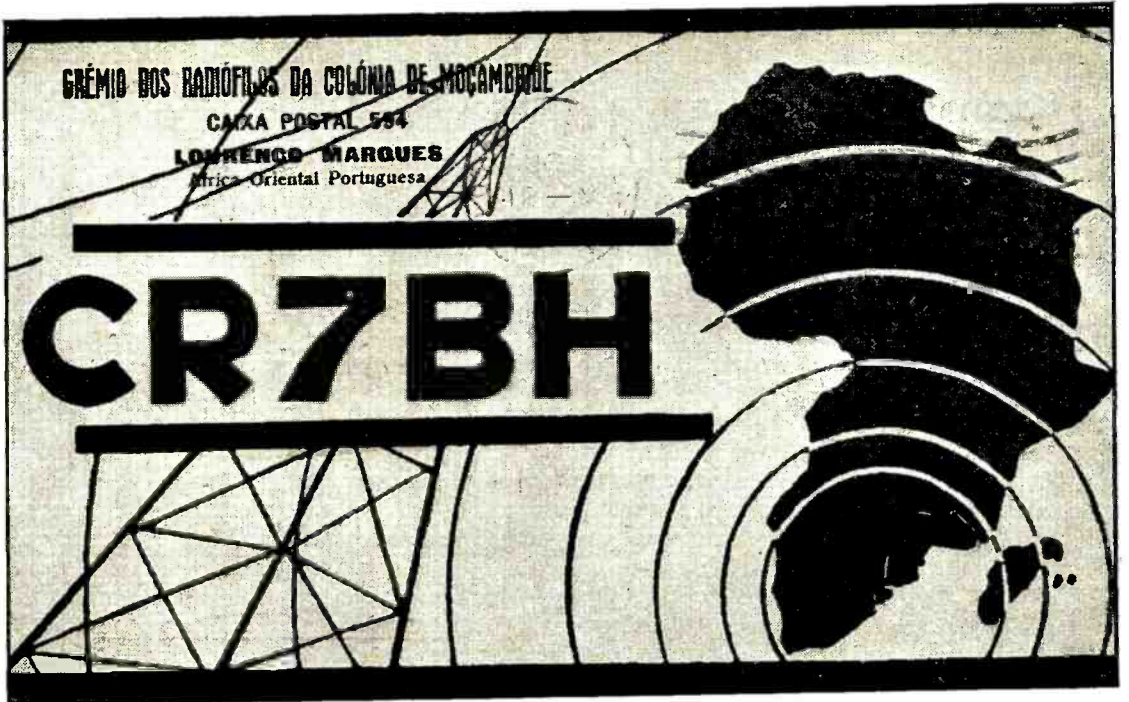

The DX Corner
(Short Waves)

(Continued from page 287)

4:30 p.m. and 7-9:10 p.m. Alfred, Lander, Sculley, Dressler, Beno, Harris, Jordan, Fleming, Shamleffer, Partner, Meehan.

OLR3A, Podebrady, Czechoslovakia, 9,550 kc., 3-10 p.m. McCartin.

OLR2A, Podebrady, Czechoslovakia, 6,010 kc. 3-6 p.m. McCartin.

GSI, Daventry, England, 15,260 kc., Eder, Daily 12:20-3:45 p.m. and 9-10 a.m. Hedgeland, 6:20-8:30 p.m. Alfred, Partner, Doyle.

GSO, Daventry, 15,180 kc., Eder, Daily 11:30 a.m.-1:45 a.m., 4-6 p.m. 6:20-8:30 p.m. Hedgeland, Alfred, Wollenschlager, Partner, Doyle.

GSJ, Daventry, England, 21,530 kc. Daily 5:45-8:55 a.m. Hedgeland, 11 p.m. Duncan, Partner, Doyle.

GSP, Daventry, England, 15,310 kc. 8:30 p.m. Nowak, Daily 6:20-8:30 p.m. Dressler, 9-11 p.m. Alfred, Wollenschlager, Jordan, Sporn, Doyle.

GSH, London, England, 21,470 kc, 6-8:55 a.m. and 9:15-12 a.m. Partner, Doyle.

GSA, Daventry, England, 6,050 kc., 6-11 p.m. Doyle

GSB, Daventry, England, 9,510 kc. daily 11:30 p.m.-1:45 a.m., 9:15-12 a.m. 12:30-3:45 p.m. and 9-11 p.m. Hedgeland, Alfred, Ducan, Partner, Doyle.

GSC, Daventry, England, 9,580 kc. Daily 6-1:30 p.m. Pena, Duncan, Doyle.

GSD, Daventry, England, 11,770 kc., Eder, Daily 11:30 p.m.-1:45 a.m., 12:20-3:45 p.m., 6:20-8:30 p.m. and 9-10 p.m., Hedgeland, Dressler, Daily, 7-10 p.m. Pena, Alfred, Wollenschlager, Fleming, Schmidt, Sporn, Partner, Doyle, Haws.

GSF, Daventry, England, 15,140 kc., Daily 4-6 p.m. and 6:20-8:30 p.m., Hedgeland, heard 8:57-11 p.m., Alfred, Wollenschlager, 9-11 p.m. (from veri) Fleming Nigh, Doyle, Eder.

GSG, Daventry, England, Daily 11:30 p.m.-1:45 a.m., 5:45-8:55 a.m., 12:20-3:45, 4-6 p.m. and 9-10 a.m., Hedgeland, Daily 7-8:15 p.m. Pena, 17,790 kc., Alfred, Wollenschlager, Sculley, Lindner, Oglesby, Wickes, Howe, Shamleffer, Partner, Doyle, Wittig.

CSW, Lisbon, Portugal, 9,940 kc., heard Friday 7-8 p.m. Shamleffer,

(11,040 kc.) 5-6 p.m. and (9,940 kc.) 6-8 p.m. Daily—Alfred, Jaime, Daily 12-9 p.m., Fleming, Nigh, 11,400 kc.—Daily 4-6:30 a.m. Doyle, Matthews, Eder.

"Radio Catolica Portuguesa" Lisbon, Portugal, 5,970 kc. Sunday 4:50 p.m. Smith.

CT1AA, Lisbon, Portugal, 9,650 kc., Saturday 4-7 p.m. McCartin, Tuesday, Thursday, and Saturday, 5-7 p.m., Alfred, Cuckoo Chimes; used Slogan: "Radio Coloniale Station" Sibbin, Sculley, Jaime, Address; Ave Antonio Augusto d' Aguiar 144, (from veri) Wilson, Fleming, 9,665 kc. Doyle.

CT1CT, Lisbon, Portugal, Tuesday 4:15 p.m.-6:15 p.m. McCartin.

CSL, Lisbon, Portugal, 12:15-8:00 a.m., McCartin.

RKI, Moscow, U. S. S. R., 15,040 kc., Eder, 15,145 kc., Sunday 1:45-3 p.m., Welper, Magunson, Daily 7-10:30 p.m. Dressler, 11-11:15 p.m. Russell, Shea, Dimmick, 15,080 kc., Alfred, Shields, Kupiec, Sahlbach, Jordan, Hartzell, Sporn, Partner, Shamleffer, Craston.

RAN, Moscow, U. S. S. R., 9,600 kc., Thursday 7-9 p.m. Blanchard, Daily 7-9:30 p.m. Dressler, Russell, Shea, Alfred, Fleming, 9,710 kc. Shields, Sporn, Shamleffer, Partner, Wittig Craston.

RNE, Moscow, U. S. S. R., 12,000 kc., Sunday 9 a.m., Schmidt.

MANCHUKUO HEARD FROM
Anatol Kabatoff, our Observer in Harbin, sends in this photo of his equipment. Notice the certificate in the Place of Honor.

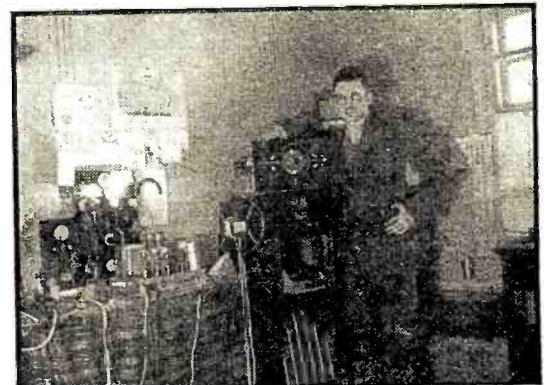

Central America

TI6PH, San Jose, Costa Rica, 5820 kc., 8 p.m.-12:15 a.m., (McCartin).
 TIPG, San Jose, Costa Rica, 6410 kc., also 9550 kc., (Millen), signed 11:45 p.m., (Alfred, Diez, Doyle). Slogan: "La Voz de la Victor".
 TIRCC, San Jose, Costa Rica, 6550 kc., daily 9 a.m.-11 p.m., (Pena, Jaime).
 TILS, San Jose, Costa Rica, 5800 kc., 7:22 p.m. (Jaime), signs 11:30 p.m. with "Good-night Song", (Fleming).
 TIEP, San Jose, Costa Rica, 6710 kc., (Diez), 7-10 p.m., (Doyle).
 HRD, La Ceiba, Honduras, 6235 kc., 8-11 p.m., (Doyle).
 TG2X, Guatemala, Guatemala, 5940 kc., daily except Sunday 5-8 or 10 p.m. (Partner).
 TGWA, Guatemala, Guatemala, 9450 kc., daily 7:30-12 p.m. (Partner), 9540 kc., (Doyle).
 YNLG, Managua, Nicaragua, 8500 kc., 8-9:15 p.m., (Alfred). Slogan: "Patua de Dario".
 YNPR, Managua, Nicaragua, weekdays 9-10 p.m., (Atherton). Slogan: "Radioemisora Pilot".
 YNGL, Managua, Nicaragua, 8610 kc., 8:30-9:15 p.m., (Shamleffer).
 HP5A, Panama City, Panama, 11,700 kc., (Kiser, Eder), daily 8:30-9 p.m., (Noyes, Markuson, Duncan, Welper, Shamleffer), daily 8-10:45 p.m., (Hartzell, Knight, Alfred, Weikal, Dressler, Skinner, Lindner, Shea), signs with "Anvil Chorus", (Fleming, Jaime, Diez, Shields, Harris, Magnuson, Partner, Atherton, Pickering), requests reports, (Stark, Sargent), Slogan: "La Voz del Istmo". Address: P. O. Box 954.
 HP5B, Panama City, Panama, 6030 kc., 8:15-11:45 p.m., (McCartin, Jaime).
 HP5J, Panama City, Panama, 9610 kc., 5:49 p.m., (Jaime), 9690 kc. (Diez), daily 7:15 p.m., (Croston).
 HP5I, Aguadulce, Panama, 11,800 kc., 7:44 p.m., (Jaime), 11,895 kc., daily 7:30-9:30 p.m., (Doyle, Partner).

South America

LRX, Buenos Aires, Argentina, 9660 kc., 9 p.m., (Nowak), daily 5-10:30 p.m., (Alfred, Fleming, Diez), relays LR1, daily 9:30-11 p.m., (Croston, Shamleffer), Slogan: "Radio El Mundo".
 LRU, Buenos Aires, Argentina, 15,290 kc., 7:30 a.m., (Sporn, Oglesby, Diez), daily 8-9 a.m., (Schmidt, Croston, Eder), 15,280 kc., (Shamleffer).
 CB615, Santiago, Chile, 12,300 kc., 7-8:30 p.m., (Harris), 6:30-8 p.m., (Shamleffer), three note chime (Fleming). Monday, Tuesday, 7:30-8:15 p.m., (Hesterman).
 PRF5, Rio de Janeiro, Brazil, 18,600 kc., (Kiser), 4:45-5:45 p.m., (Doyle).
 PRADO, Riobamba, Ecuador, 6620 kc., Saturday 12-1:15 a.m., (McCartin), Thursday, 9:30-11:30 p.m., (Alfred, Croston).
 HC2RL, Guayaquil, Ecuador, 6670 kc., 9:45 p.m., (Jaime), 6630 kc., Sunday, 5:45-7:45 p.m., Tuesday 9:15-11:15 p.m., (from veri.), (Fleming). Slogan: "Quinta Piedad".
 HJ3ABH, Bogota, Columbia, 6010 kc., 7-12 p.m., (McCartin).
 HJ3ABX, Bogota, Colombia, 6122 kc., weekdays 5:30-11:30 p.m., Sunday 5-11 p.m., (Hartzell).
 HJ1ABG, Barranquilla, Colombia, 6040 kc., 7-11:15 p.m., (McCartin).
 HJ1ABB, Barranquilla, Colombia, 4780 kc., (Unger), 9560 kc., daily 9-10 a.m., 7-7:30 p.m., (Pena), signed 11 p.m., (Shea, Skinner, Shields, Eder).
 HJ1ABJ, Santa Marta, Colombia, 6025 kc., daily except Sunday 5:30-10:30 p.m., (Hartzell).
 HJ5ARD, Cali, Colombia, 6080 kc., 7-11:30 p.m., (McCartin).
 HJ4ABH, Armenia, Colombia, 9520 kc., (Eder), 6-10 p.m., uses chimes, (Fleming), 9708 kc., (Diez, Wittig).
 HJ4ABL, Manizales, Colombia, 6070 kc., 6:45-8:15 p.m., (McCartin).
 HJ4ABB, Manizales, Colombia, 6100 kc., 7-11:45 p.m., (McCartin).
 YV1RB, Maracaibo, Venezuela, 5850 kc., (Eder), 6-10 p.m., (McCartin).
 YV1RL, Maracaibo, Venezuela, 5930 kc., daily 4:45-9:45 p.m., (Hartzell).
 YV5RC, Caracas, Venezuela, 5800 kc., (Eder), 8 p.m., daily 5:15-9:30 p.m., (Schmidt), 6:50 kc., 10:30 p.m., (Wittig, Fleming), Slogan: "La Habla a la Nacion".
 YV5RP, Caracas, Venezuela, 6290 kc., irregular, (Lindner), Slogan: "La Voz de la Philco".
 YV4RB, YV4RV, Valencia, Venezuela, 6520 kc., 6:20-10:20 p.m., (McCartin), relays YVRR, irregular, 8-10 a.m., (Pena), (Shrock), Slogan: "La Voz de Valencia", Slogan: "La Voz de Carahobo".
 OAX4J, Lima, Peru, 9520 kc., 8:34 p.m., (Jaime), 9300 kc., Saturday 12 p.m., (Smith), 9350 kc., (Shamleffer), from veri., (Meehan), Slogan: "Radio International". Address P. O. Box 1166.
 OAX4Z, Lima, Peru, 6090 kc., daily 9-11:30 p.m., Sunday 9 p.m.-1 a.m., (Westman, Eder), 6070 kc., (Piorco, Matthews), Slogan: "Radio Nacional".
 OAX4I, Lima, Peru, 9330 kc., daily 7-10 p.m., (Fleming), Slogan: "Radio National".
 OAX5A, Ica, Peru, 11,796 kc., daily 12-4 p.m., 7-11:30 p.m., (from veri.), (Markuson, Wilson).
 OAX1A, Chiclayo, Peru, 6150 kc., 8-11 p.m.,

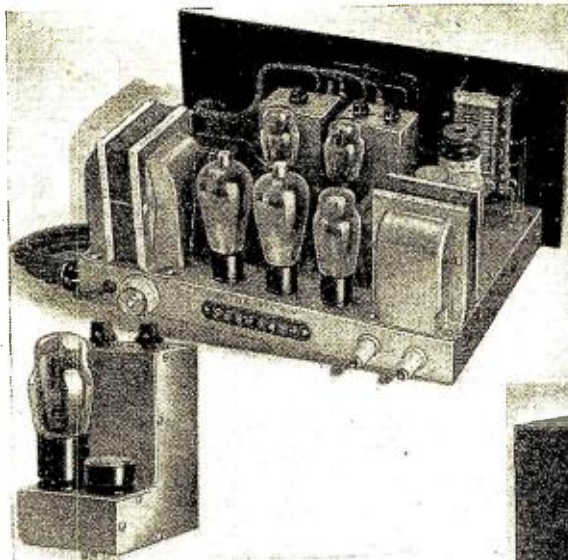

Read Article giving full description in last month's issue of "RADIO NEWS"

**THE
TRANSMITTER
HIT OF
1937**

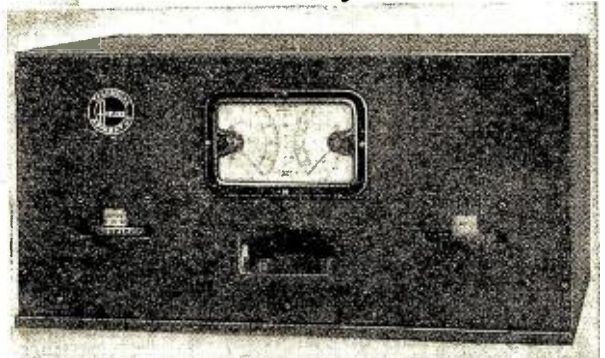

● 60 Watts CW output on 20, 40, 80 and 160 Meter Amateur Bands—40 watts on 10-meters. About 20 watts on 'phone may be obtained when used with correct Audio Amplifier. No larger than ordinary receiver—weighs only 60 lbs. Fool-proof switching arrangement compels correct switching sequence both during tuning up procedure and in actual operating service. Plug-in crystal and doubler stages—completely self contained; allow very rapid band changes. *Monthly Payment Terms!*

**MONTGOMERY
WARD**

CHICAGO • BALTIMORE • ALBANY • ST. PAUL
DENVER • KANSAS CITY • PORTLAND • OAKLAND
JACKSONVILLE • FT. WORTH

ONLY \$9 DOWN, \$8 A MONTH

Write today concerning details on this miracle transmitter and other Ham equipment. Address Dept. RN-10, Radio Engineering, Chicago. Ward's sensational radio catalog is also yours for the asking; mail coupon for your free copy TODAY.

MONTGOMERY WARD Dept. RN-10

Please send me a copy of your 1937 Radio Catalog.

Name

Street and No.

City

State

**MR. SERVICEMAN
DO YOU KNOW
THAT KENYON**

**REPLACEMENT COMPONENTS
NEVER GET THE "GONG"!**

Replace with Kenyon Audio and Power Components. And rest assured your Customer will be Satisfied.

Our New Replacement Catalog contains over 100 items.

*Obtainable From Your Local
Jobbers*

KENYON TRANSFORMER CO. INC.

840 Barry St., New York, N. Y.

Export Dept.

25 Warren St., New York, N. Y.

NOT "Just Another" VOLUME

A GREAT STEP

toward the
**PERFECT
MANUAL**



VOL. VIII
OVER 1600 PAGES
Plus supplement

**OUT
NOV. 10TH**

1. **MANUAL:** Over 1600 pages give complete circuit data on 1937-38 sets of over 100 manufacturers.

2. **INDEX:** Of about 120 pages makes it easy to find data in all 8 Rider Manuals.

3. **"HOW IT WORKS"**
A separate section describes the technical features of new sets, such as A. F. C.—motorized tuning, etc.

Servicemen have given VOL. VIII the biggest reception ever accorded a Rider Manual. They recognized and appreciated the extra services it performed. It furnishes mechanical as well as circuit data on the new sets.

JOHN F. RIDER
Publisher
1440 Broadway, New York

**YOU NEED ALL 8
Rider
MANUALS**

METALEX HORNS

A Boon To the
Sound Engineer

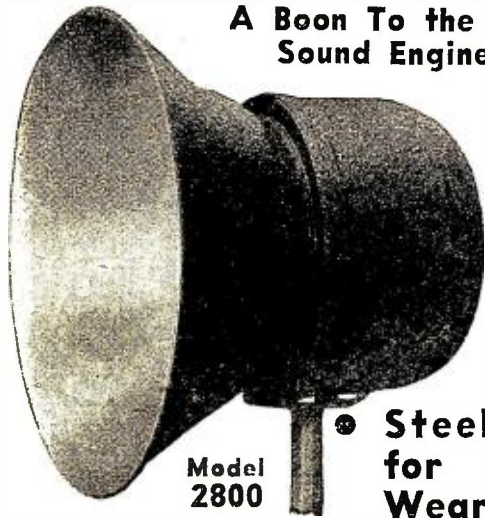

Model
2800

• Steel
for
Wear

• "EX" for Objectionable Resonances

The enthusiastic expression we are receiving regarding the Metalex Horn makes us want everyone interested in public address work, to try one.

These efficient exponential horns should not be confused with the so-called parabolic units. Spun from steel and coated with the material "Ex", these Metalex horns give almost unlimited wear and have no objectionable resonances. Stocked in 3 sizes.

The Model N M 2900—12" Nokoil speaker installed in a Metalex Horn gives almost unbelievable reproduction.

Write for interesting literature.

Wright-DeCoster Distributors are always anxious to cooperate.

WRIGHT-DeCOSTER, Inc.

2255 University Ave., St. Paul, Minn.
Export Dept.: M. Simons & Son Co., New York
Wm. F. Kelly Co., Toronto, Ont., Canada.
Taylor & Pearson, Ltd., Edmonton, Alta., Canada

"LET ME TRAIN YOU *at home*



FOR A GOOD RADIO JOB"

Get in Line for Big Money!

Radio is growing fast. Modern receivers require thoroughly trained experts for service and maintenance. You can become such an expert... right at home... through R.T.A. methods and begin earning money almost from the start of your course. In a very short time you will

Be the ONE Man in
1,000

who understands everything there is to know in order to give quick "sure-fire" service to all kinds of receivers. You can be the one man who can take the service business away from the old-time radio "tinker."

No Experience Needed

Even though you know nothing about Radio now, you can quickly qualify the R.T.A. way to step right into a well paying position—or start your own profitable business. Use your spare time and

LEARN AT HOME

Most R.T.A. members start making money right from the beginning. The special servicing equipment which is supplied without extra cost makes this possible. Don't wait—get started now. Write today for our interesting Radio Book FREE.

INCLUDED WITH OUR TRAINING



This efficient time-saving, trouble-finding Circuit Analyzer and Resistance Tester helps you to make money without delay.

Don't Put It Off—Send Coupon Now

RADIO TRAINING ASSOCIATION OF AMERICA
4525 Ravenswood Ave., Dept. RN-117, Chicago, Ill.

RADIO TRAINING ASSN. of AMERICA
Dept. RN-117, 4525 Ravenswood Ave., Chicago, Ill.
Gentlemen: Send me details of your Enrollment Plan and information on how to learn to make real money in radio quick.

Name.....
Address.....
City..... State.....

COLOMBIA STATION
BROADCASTING STATION
HJ1-ABP
9.690 K.C. - 31.25 METERS - S.O. BOX 57
MR. John S. CHOKAN, Jr.
3935 W. 105th St. (Up)
Cleveland, Ohio, U.S.A.
Dear Sir: Your reception on the 11 of June 1, 1937 has been verified. Thanks for your kind report. Sincerely yours,
Radiodifusora Cartagena S.A.
MANAGER

(from veri.), (Wilson). Slogan: "Radio Delcar". Address: Casila No. 9.
CB960, Santiago, Chile, 9600 kc., daily 6:8-30 p.m., (Hartzell).
PZH, Paramaribo, Dutch Guiana, 6800 kc., 3:8-4:5 p.m., (Unger, Skinner), weekdays 5:45-9:45 p.m., (Hartzell).
VP3MR, Georgetown, British Guiana, 6070 kc., Monday, Thursday, Saturday, 4:15-8:15 p.m., Sunday 7:45-10:45 a.m., (from veri.), (Shea).

West Indies

PCJ1, Curacao, Dutch West Indies, 5930 kc., weekdays 6:36-8:36 p.m., (Shea).
HH3W, Port-au-Prince, Haiti, 9645 kc., 1-2 p.m. and 7-8 p.m., (Croston).
COCO, Havana, Cuba, 6010 kc., heard 6 p.m.-2 a.m., (McCartin), 9:45 p.m., (Nowak, Wicks, Margrie).
COBC, Havana, Cuba, 9370 kc., heard 8 a.m.-11 p.m., (Davenport, Shea), 9350 kc., 9000 kc., heard 7 p.m.-2 a.m., (Alfred, Jaime) Sunday, 8-10 a.m., relays CMBC, (Magnuson), 9463 kc., (Diez, Fleming, Harris, Partner, Sargent, Eder, Pickering). Slogan: "Del Progress Cubana". Address: P. O. Box 192.
CO9CZ, (CO9BZ, COBZ, CO9Z), Havana, Cuba, 9000 kc., heard 9 p.m. Thursday, relays CMCK, also Friday, 7 p.m. (Shamleffer, Nowak, Dressler), 9200 kc. (Shea), daily 7:30 p.m.-1 a.m. (Jaime, Smith), relays CMBZ (Schrock, Diez, Harris, Magnuson, Sahlback), daily 4-9 p.m. (Partner, Eder). Slogan: "Radio Salas." Address P. O. Box 866.
COCW, Havana, Cuba, 6324 kc., relays CMW, daily until midnight. (Hartzell), 6:55-1 a.m. (Jaime), four chimes used. (Skinner) daily 6-11 p.m., (from ann.), (Partner). Slogan: "La Voz de las Antillas". Address P. O. Box 130.
COKG, Santiago, Cuba, 6200 kc., heard 5-9 p.m., (Hartzell).
COCM, Havana, Cuba, 9860 kc., daily 8 a.m.-12 midnight, (Jaime, Stark), 9830 kc., irreg., (Hartzell, Atherton, Shamleffer), 9775 kc., (Eder). Slogan: "Trans-radio Columbia". Address: P. O. Box 33.
COGF, Matanzas, Cuba, 11,790 kc., desires reports, (Eder, Kiser) heard 9:04-10:20 p.m., (Duncan, Lindner, Piorko), daily 7-10 p.m., (Dressler, Shea), heard 1-6 p.m., relays CMGF, (11,200 kc.) (Alfred), daily 8-11 p.m., (Weikal, Schrock, Sekach, Sinoisky, Fleming, Jaime, Harris, Atherton), signs with organ selection, "Mon Cheri", (Skinner, Shamleffer, Partner, Matthews, Pickering). Address: Bellaucourt 51 (Playa).

COJK (COJQ), Camaguey, Cuba, 8660 kc., (Eder), heard 11:10 p.m., (Kiser), 8665 kc., daily except Sunday, 7:30-9:45 p.m., (Dressler, Shea), chimes every 1/4 hour, (Alfred, Jaime, Lindner), relays CMJK, (Magnuson, Shamleffer, Markuson, Sargent, Matthews, Pickering). Slogan: "Radio Zenith". Address: Finlay 3, Camaguey.
COCB, Havana, Cuba, 6130 kc., (Eder), 6120 kc., heard 8 p.m.-1 a.m., (McCartin).
COCH, Havana, Cuba, 9420 kc., (Eder), 9430 kc., heard 1:20 p.m.-2:15 a.m., (McCartin, Wallenschlager), 9530 kc., (Diez), 8:30 a.m. and 10:30 p.m., (Fleming, Wicko, Shamleffer, Kashimoto, Wittig).
COCQ, Havana, Cuba, 9750 kc., (Eder) heard 8-11:30 p.m., (Sporn, Nowak, Wallenschlager, Redmond, Sibbin), daily 4-12 p.m., (Dressler, Lindner), 9850 kc., (Diez, Shields, Fleming, Kashimoto Wittig).
COCX, Havana, Cuba, 11,490 kc., (Eder, Wallenschlager) reports requested, (Sibbin), 11,500 kc., daily 4 p.m.-1 a.m., (Dressler), 11,600 kc., heard 11 a.m., (Nigh), 11,455 kc., signs at 6 p.m., (Shamleffer, Pickering).
HIN, Trujillo City, Dominican Republic, 6240 kc., (Eder), heard 8:45-10:15 p.m., (McCartin), 11,280 kc., (Kiser), 5350 kc., (Alfred) heard 1 a.m., (Nigh), 12,486 kc., (harmonic), (Sham-



A "VERI" AND ITS STATION
Observer J. S. Chokan, Jr., of Cleveland, Ohio, received the above card from HJ1AP. The transmitter house is also pictured.

leffer, Sargent). Slogan: "La Voz del Partido Dominicanos".
HIT, Trujillo City, Dominican Republic, 6630 kc., heard 7-10 p.m., (McCartin, Blanchard). Slogan: "The Voice of R. C. A."
HIZ, Trujillo City, Dominican Republic, 6320 kc., heard 5:20-9:30 p.m., (McCartin).

Africa

VQ7LO, Nairobi, Kenya Colony, 6080 kc., heard signing at 2:15 p.m., schedule: Monday, Wednesday and Saturday, 5:30-6 a.m. & 11:15 a.m.-2:15 p.m.; Tuesday & Thursday, 5:30-6 a.m. & 8:15-9:15 a.m. & 11:15 a.m.-2:15 p.m.; Sunday, 10:45 a.m.-1:45 p.m. (Abbott), Sunday, 11:15 a.m.-2:15 p.m., Monday, Thursday, Friday, 6-6:30 a.m. & 11:45 a.m.-2:45 p.m., (Wilson).
(CR7AA) CR7BH, Lourenco Marques, Mozambique, 11,720 kc., (Anderson) 6137 kc., (Goetsch) daily 9:30-11 a.m. & Sunday 6-8 a.m., (Doyle, Partner). Address: P. O. Box 594.
EA9AH, Tetuan, Spanish Morocco, 14,030 kc., (Shea), 6-12 p.m. (Harris) (from veri.), (Shamleffer, Atherton, Diez) 6500 kc., (Doyle) 14,610 kc. (Hesterman). Slogans: "Viva Franco" and "Viva España". Address: P.O. Box 124.
EAJ43, Tenerife, Canary Islands, 10,370 kc., daily 2-8 p.m., (from veri.) (Shea) 10,350 kc., (Diez) 10,360 kc., daily 8-10 p.m., (Doyle) heard Monday, 7:35-8:10 p.m. (Hesterman).
CR6AA, Lobito, Angola, 7177 and 9666 kc., Wednesday and Saturday, 2:45-4:30 p.m. (Shea).
OPM, Leopoldville, Belgian Congo, 20,040 kc., daily 2-2:30 p.m. (From veri.), (Wilson).
OPL, Leopoldville, Belgian Congo, 20,040 kc., daily 4:30-11:30 a.m. (from veri.), (Wilson).

Oceania

VK2ME, Sydney, Australia, 9590 kc., Sunday, 5-6 a.m., (Dresler, Louder) 9690 kc., (Shields).
VK6ME, Perth, West Australia, 9590 kc., heard 7-9 a.m., (Sporn, Louder, Sibbin) daily except Sunday 6-8 a.m., (Shea, Gertenback, Eder).
FO8AA, Papeete, Tahiti, 7100 kc., heard 11 p.m., (Schrock) Tuesday and Friday, 11 p.m.-12:30 a.m., (Shea, Doyle).
W10XDA, Schooner Morissey, 12,862 and 17,310 kc., heard Tuesday 6:15 p.m. and Thursday 7:30 p.m., (Blanchard).
VK3ME, Melbourne, Australia, 9510 kc., daily

except Sunday, 4-7 a.m. (Kiser, Dressler), 9500 kc. (Alfred), constructive reports requested (Londer, Oglesby, Doyle, Pickering, Eder).
 KZRM, Manila, Philippine Islands, 9570 kc., Sunday, Thursday, Friday, 6-9 p.m.; Saturday, 6-10:30 p.m. (Wertman, Sibbin, Gertenback, Hartzell). Slogan: "Radio Manila."
 VK3LR, Melbourne, Australia, 9580 kc., daily 5:30-6:15 a.m. (Dresler, Alfred), daily 4:30-8:30 a.m. (from veri.) (Fleming, Beard, Doyle, Pickering, Eder).
 VK9MI, S.S. Kanimbla, 6010 kc., heard Sunday 6:55-7:30 a.m. (Craston, Partner).
 VK2MW, Sydney, Australia, 9585 kc., heard 6-6:30 a.m. (Doyle).
 VPD2, Suva, Fiji Islands, 9540 kc., heard 5:15-7 a.m. (Alfred, Shea), 9520 kc. (Pickering, Eder).

Asia

JVT, Nazaki, Japan, 6750 kc., irreg. from 11 p.m. (Westman), daily 7-8:10 p.m. (Ruiz).
 JZJ, Nazaki, Japan, 11,800 kc., heard 4:15-5:15 p.m. (McCartin), special program 5:30-6:30 p.m., reports requested (Williams), daily 8-9 a.m. (Noyes), daily 4-7:30 a.m., 1-2 a.m., 9-10 p.m., 2:30-3:30 p.m. (Ruiz, Welper, Eder, Shea), daily 8-9 a.m. (Alfred, Weikal, Schrock, Markuson, Hows, Fleming, Beno, Kashimoto, Hartzell, Magnuson, Partner, Matthews, Beard, Doyle). Slogan: "The Voice of Tokio." Same address as JZK.
 JZK, Nazaki, Japan, 15,160 kc., daily 4-5 p.m. (Truax), special program daily, 6:30-7:30 a.m. (from veri.) (Williams), signs with chimes (Noyes), daily 5:20-5:40 p.m., 1-2 a.m., 9-10 p.m. and 2:30-3:30 p.m. (Ruiz, Welper, Eder, Shea), daily 8:9 a.m. (Alfred, Weikal, Schrock, Wallenschlager), daily 9-10 a.m. (Gertenback, Markuson, Nigh, Hows, Kashimoto, Hartzell, Magnuson, Fleming, Partner, Matthews, Beard, Doyle). Address: Kokusai-Denwa Kaisha Ltd., No. 3 1-Chrome, Uchisaiwaicho, Kojimachiku, Tokyo.
 JV7, Nazaki, Japan, 7510 kc., daily 9:40-9:45 p.m. and 2:30-3:30 p.m. (from veri.) (Ruiz).
 JZI, Nazaki, Japan, 9535 kc., daily 10:40-11:10 p.m., 9-10 p.m., 2:30-3:30 p.m. (from veri.) (Ruiz, Doyle).
 JVN, Nazaki, Japan, 10,660 kc., daily 1:50-2:20 a.m., 1-2 a.m. (from veri.) (Ruiz, Dressler, Shea), daily 4-5 p.m. (from veri.) (Ruiz, 5-7:45 a.m. (Alfred, Pickering, Eder).
 JVM, Nazaki, Japan, 10,740 kc., daily 4-7:30 a.m. and 2:30-3:30 p.m. (Ruiz).
 JVH, Nazaki, Japan, 14,600 kc., daily 7:30-8 a.m. and 1-2 a.m. (from veri.) (Ruiz, Shea).
 JIB, Tyureki, Formosa, 10,535 kc., daily at 6 a.m. (Alfred) daily with news, 10-10:30 a.m. (Partner).
 JDY, Dairen (Kuantung Peninsula), 9925 kc., daily 7-8 a.m., relays JOAK (Partner).
 JVE, Nazaki, Japan, 15,665 kc., heard Wednesday, 1:05-2:15 a.m., reports appreciated (Hestermin). Address: Nipponese Broadcasting Co., Tokyo.
 CQN, Macao, Portuguese China, 9667 kc., heard Monday, 7:40 a.m. (Fleming), 10:15-11:30 kc., Monday and Friday, 7:15-8 a.m. (Partner).
 TBD, Shinkio, Manchukuo, 10,055 kc. (Diez), 10,065 kc., 6-6:20 a.m. (Craston).
 "Philco Radio," Saigon, Indo-China, 11,710 kc., daily 5:30-9:30 a.m. Also on 5980 kc. (from veri.) (Partner).
 XGOX, Nanking, China, 6820 kc., 5:30-8:30 a.m., and Sunday, 7-9 a.m. (Doyle).

THROUGH TEN YEARS OF SERVICE

This is the 20-kw. transmitter at PCJ, the famous Dutch short-waver.

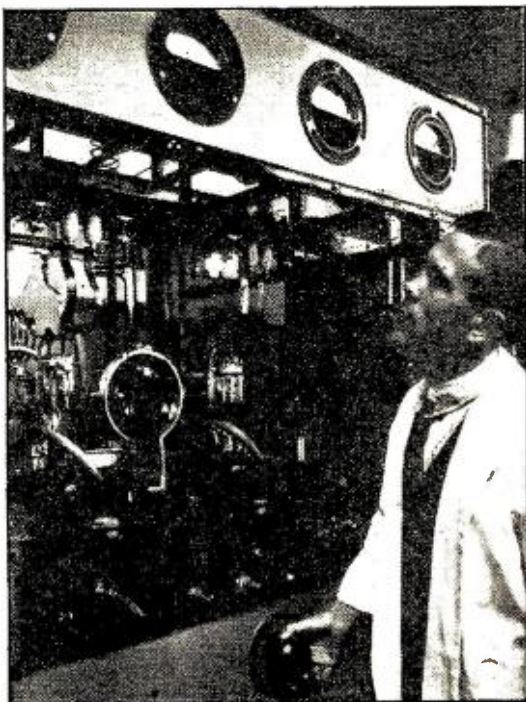

XOJ, Shanghai, China, 15,790 kc., heard 10:45 a.m. (Sporn), 158.00 (Shea, Alfred).
 ZBW3, Hong Kong, China, 9525 kc., heard 6 a.m. (Shea), daily 7-10:30 a.m. (Partner, Goetsch, Doyle).
 PMN, Bandoeng, Java, 10,260 kc., daily 5:30-10:30 a.m., Saturday until 11 a.m. (Partner, Pickering).
 YDC, Soerabaja, Java, 15,160 kc., heard 6-8:30 p.m., relays PLV and PMN (Pierko, Eder; 15.150 kc., daily 5:30-10 a.m., Saturday until 11 a.m. (Partner).
 PMH, Bandoeng, Java, 6720 kc., heard 5:30-10 a.m. (Unger, Partner).
 YDB, Soerabaja, Java, 9550 kc. (Eder), daily 5:30-10 a.m., Saturday until 11 a.m. (Partner), 9660 kc. (Goetsch).
 PLP, Bandoeng, Java, 1,000 kc., heard 5:30-7:30 or 11:30 a.m. (Shea, Fleming, Wicks), daily 5:30-10 a.m., Saturday until 11 a.m. (Partner, Pickering).
 HS8PJ, Bangkok, Siam, 19,020 kc., schedule: Monday (Abbott), 9350 kc., heard 3:10 a.m. (Sporn), 9450 kc., heard Thursday, 8 a.m. (Shea), Thursday, 8-10 a.m. (Partner, Craston).
 YPB, Colombo, Ceylon, 6097 kc., heard 6:30-11:30 a.m. (Tynan), 6160 kc., daily 6:30-9 a.m. (and 10 a.m. irreg.) (from veri.) (Wilson, Partner, Doyle). Address: Broadcasting Office, Tamington Square, Colombo.
 ZGE, Kuala Lumpur, Federated Malay States, 6170 to 6250 kc., Sunday, Tuesday and Friday, 6:40-8:40 a.m. (Partner, Matthews).
 "Radio Burma," Rangoon, Burma, India, 6007 kc., heard 9:10-9:40 a.m. (Craston).

North America

XEBM, Mazatlan, Sonora, Mexico, 15,300 kc., heard 8:15-11 p.m., and 3-6 p.m. (Alfred, Oglesby).
 XEPW, Mexico, D. F., Mexico, 6110 kc., heard 11:11 p.m. (Jaime), 8:30 p.m.-1:30 a.m. (Doyle), daily 9-12 p.m. (Partner).
 XEME, Merida, Yucatan, Mexico, 9520 kc., heard 11-12 p.m. (Doyle, Gallagher).
 XEBT, Mexico, D.F., Mexico, 6000 kc., heard 8 p.m.-2:15 a.m., (McCartin, Eder).
 XEWW, Mexico, D.F., Mexico, four tone chimes, heard 7-12 p.m. (Pierko, Nowak, Shea), 3-6 p.m. and 8-12 p.m. (Alfred, Weikal, Schrock, Smith, Skinner, Harris, Shamleffer), daily 7 p.m.-1 a.m., 9500 kc., daily 8 a.m.-1 p.m., 15,150-15,170 kc. (Partner, Sargent). Slogan: "La Voz de America Latina de Mexico." Address: P.O. Box 2516.
 XEWI, Mexico, D.F., Mexico, 11,900 kc., siren used, call in English, heard 11 p.m. (Smith, Pickering, Shamleffer). Address: P. O. Box 2874.
 XEBR, Hermosillo, Mexico, 11,820 kc., relays XEBH, 3-6 p.m. and 11 p.m.-2 a.m. (Wicks, Pickering).
 CJRO, Winnipeg, Canada, 6150 kc., heard 11:30 p.m. (Jaime), 6160 kc., 6-12 p.m. (from veri.) (Fleming).
 CJRX, Winnipeg, Canada, 11,720 kc. (Noyes, Wallenschlager), 11,730 kc., 6-12 p.m. (from veri.) (Fleming, Doyle, Shamleffer).
 CFCX, Montreal, Canada, 6000 kc., heard 6-11:30 p.m. (McCartin), daily 7:45-12 a.m. (Hartzell, Jaime).
 CRCX, Toronto, Canada, 6090 kc., heard Sunday, 11:30 a.m.-11:30 p.m. (McCartin), 11,810 kc., heard 1:30 p.m., Nowak, Doyle).
 VE9HX, Halifax, Nova Scotia, Canada, 6130 kc., heard 9 a.m.-1:15 a.m. (McCartin), 7:30-11:30 a.m. (Sporn), relays CHNS, schedule: 1-4 p.m. and 5-11 p.m. (Wilson), 6110 kc. (Doyle). Address: Lord Nelson Hotel.
 W2XAF, Schenectady, N. Y., 9530 kc., signs at 11 p.m. (Nowak), heard 4:45 p.m. (Sculley), heard 9:55 p.m. (Duncan), daily 4-12 p.m. (Gertenback, Wittig). Slogan: "Voice of Electricity." Address: 1 River Road.
 W3XAU, Philadelphia, Pa., 6060 kc., heard 8:11 p.m. (McCartin), heard 5 p.m. (Sculley, Oglesby, Duncan).
 WQB, Rocky Point, N. Y., 17,940 kc., heard Saturday 7-7:30 p.m. (Alfred).
 W2XAD, Schenectady, N. Y., 15,150 kc. (Wallenschlager, Lindner), 15,300 kc. (Diez, Beard).
 W8XX, Pittsburgh, Pa., 15,620 kc., heard 12:15 p.m. (Sculley), 11,870 kc., heard 8 p.m. (Nigh) (21,540 kc.) 6:45-9 a.m. 11,870 kc.) 7-10 p.m., (15,210 kc.) 9 a.m.-7 p.m. and (6410 kc.) 10 p.m.-1 a.m. (Meehan).
 W2XED, Hicksville, N. Y., 17,310 kc., heard 11-11:30 a.m. (Kiser).
 W2XE, New York, N. Y., 11,830 kc., heard 9:30 p.m. (Duncan), 7 a.m.-10 p.m. (Nowak), schedule: daily (21,520 kc), 7-10:30 a.m., (15,270 kc.) 3-6 p.m., (11,830 kc.), 7-12 p.m., (Alfred, Wallenschlager, Duncan, Lindner, Diez), signs 3 p.m. (Fleming, Wittig, Craston).
 W3XAL, Bound Brook, N. J., 17,780 kc., heard 6 p.m. (Duncan), heard sign 8 p.m. (Alfred, Diez, Beard), daily 8 a.m.-8 p.m. (Partner, Shamleffer, Howe).
 W9XF, Chicago, Illinois, 6100 kc., heard 6:20 p.m. (Duncan), Sunday, Thursday, Friday, 10:05 p.m.-1 a.m., and Saturday, 12:05 a.m.-1 a.m. (Marshall, Nigh, relays WENR (Meehan).
 W1XAL, Boston, Mass., 14,800 kc., heard Tuesday, 8 p.m., wants reports (Lindner), 11,790 kc., reports requested (Fleming), 17,790-15-250 kc. (Shamleffer).
 W8XAL, Cincinnati, Ohio, 6060 kc., daily 6:30 a.m.-7 p.m., and 10 p.m.-2 a.m. (from veri.) (Fleming), 6120 kc. (Wittig, Meehan).
 KHAZT, Tacoma, Wash., 12,862 kc., heard 2 p.m. (Wicks).

1938's Radio Sensation—with every desirable new feature—at an amazingly low price. Electric Push-Button Tuning—press a button and there's your station instantly! Select-O-Matic 9" horizontal dial with all ranges in full view! Giant 12" Electro-dynamic Speaker for perfect tone! Tunes everything on the air! Three full wave-bands from 16 to 550 meters. Powerful new R.C.A. and Hazeltine licensed Superhet circuit incorporates: full 7 Watts Output; Double-tuned I.F.'s; R.F. Preset; 3-gang Condenser; A.V.C.; Tone Control, etc. No other radio has all these features at so low a price. Here's the set that will bring you tremendous sales volume and big profits. See this new radio and 64 other new KNIGHT models in the 1938 ALLIED Catalog. Models from 5 to 16 tubes for AC, AC-DC, 6 Volt, 32 Volt, Battery, and Auto operation. These new KNIGHTS are Radio's Outstanding Values! Send coupon for Catalog today.

Latest IN TEST EQUIPMENT

ALLIED's 1938 Catalog shows you every type of test instrument. New 2" Cathode Ray Oscilloscope. New analyzers, tube-checkers, set-testers, meters, signal generators—in every nationally-known brand: Supreme, Clough-Brengle, Triplett, R.C.A., Readrite, Weston, Million, and others. All standard equipment at radio's lowest prices!



Lowest Prices ON PARTS

In ONE book—more than 12,000 exact duplicate and replacement parts for building or repairing any circuit. More than 30 new Build-Your-Own kits, including the new Meissner 14 Tube All-Wave Super. Write for Free Parts Lists for building any circuit in any radio publication.

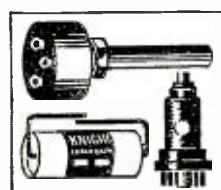

P.A. SYSTEMS—AMATEUR GEAR

New KNIGHT "Integrated" Sound Systems for every need. New Amateur receivers, transmitters, transceivers. ALLIED's new 164-page Catalog shows you Everything in Radio for Dealer, Serviceman, P.A. Specialist, and Amateur-Experimenter. ALLIED's complete stocks and fast service save you time. ALLIED's low prices save you money. Write today for ALLIED's Complete Supply Guide—Radio's Greatest Catalog. Send coupon now.



ALLIED RADIO

ALLIED RADIO CORPORATION
 DEPT. 1-LB
 833 W. JACKSON BLVD.
 CHICAGO

Send your Free 1938 Catalog.
 Send Free Parts Lists for.....

Name

Address

City..... State.....

EVERYTHING IN RADIO AT LOWEST PRICES

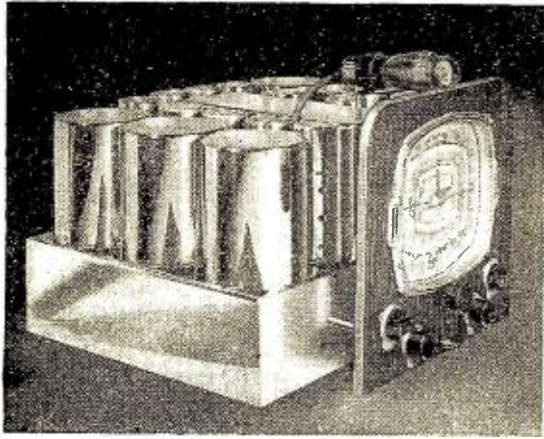

Announcing the New SCOTT SIXTEEN

- Sensitivity better than 0.6 microvolt • Selectivity exceeding every present day requirement on either broadcast band or short waves • Three Noise Suppression Systems for quieter distant reception • Precision Built and Guaranteed for Five Years • Laboratory Type Non-Directional Sound Projection System • 50% Higher Fidelity than average radio • Undistorted Power Output 300% greater than that of most receivers • Separate Bass and Treble Controls, both Continuously Variable • Two Separate Automatic Gain Control Systems • 16 Latest Type Tubes • Two Chromium 16 Gauge Steel Chassis • Precision Calibrated • Economical operating costs • Tone Balanced Volume Control • No elaborate aerial necessary • Sensitivity Control • Local Installation and Service Facilities in over 500 major cities • Costs less than many ordinary 10 and 12 tube receivers • Liberal Time Payments • 30 Day Home Trial anywhere in U. S. A. • Over 80 other amazing features.

CLIP COUPON BELOW AND MAIL TODAY!

E. H. Scott Radio Laboratories, Inc.
4440 Ravenswood Avenue, Dept. 5T7, Chicago

Please rush FREE data, prices, and special offer on new Scott Sixteen. (No obligation).

Name _____

Address _____

City & State _____

\$100 for a RADIO KEY!!?

WORTH IT, but I only charge \$9.50
This semi-automatic key makes it easy to send! Dot stabilizer equipped. Selected main-spring. Marbleite finish base stays put. Chromium metal parts. Proper height for tireless, rhythmic sending. New 1938 Mac Key only \$9.50. Order Today! Also New Mac Straight Key—best ever—only \$1.50. Mac Oscillator \$4.50. Immediate delivery. Write for complete dope on other Mac items of tremendous help to radio ops.

T. R. McELROY—175 Congress St., Boston, Mass.
WORLD'S CHAMPION TELEGRAPHER

MANHEIM POCKET SLIDE RULE
Polished stainless steel back frame, flexible scale slide, glass hairline runner, A B C D scales. Length closed 6". No celluloid—no wood. Non-shrinking. Accuracy guaranteed. In leather case with instruction booklet.

ONLY \$1.00
Postage Paid
Sevan Co.
Dept. 18
7 E. 42 St.
New York City



CANDLER TRAINED OPERATORS

Know their Stuff!

YOU ACQUIRE CODE SKILL plus A RADIO EDUCATION WHEN YOU'RE CANDLER TRAINED

Why stumble along by yourself, trying to learn code the hard way? Walter Candler will develop your sending and receiving senses to work automatically. You will read entire words—even sentences of code. Just as easily as you read print! It's so easy when you practice right! And that's not all! Candler trains you in the Theory and Practice of Radio. You get code training PLUS a radio education—all at one surprisingly low price! Walter Candler is personally interested in making every one of his students an all 'round good operator. Write Candler Today! He'll soon have you pounding brass with the best of them!

FREE Book of Facts Write Today.

CANDLER SYSTEM CO.

Department N-11
Asheville, N.C., U.S.A.



Readers Who Are Awarded "Honorable Mention" for Their Work in Connection with This Month's Short-Wave Report

Raymond Hernday, Jack Page, M. R. Kiser, Jr., Lee Meade Williams, Olof Liljegren, A. Sainz de la Pena, Simon McCartin, R. J. Abbott, Sydney G. Millen, A. T. Anderson, P. Piorko, Chas. Biggs, P. L. Stiles, Oscar Westman, T. F. Tynan, Kenneth Dressler, Harold E. Lindner, Troy Welper, M. J. Markuson, Burnell Unger, Jose Ruiz, Gustave A. Magnuson, Clarence Hartzell, R. F. Shamleffer, Irving Sporn, Lloyd Davenport, Elmer Duncan, Wells Gresham, Ed. Nowak, Jr., Robert L. Blanchard, Jr., Carl and Ann Eder, Michael Hedgeland, Donald C. Truax, Wm. Dean Noyes, Gil Harris, Dan T. Wollenschlager, J. C. Sibbon, H. Francis Shea, Bill Lander, Harold Murray, Wm. Skinner, Steve Beno, John Kupiec, Elmer F. Shields, Fred W. Alfred, Edward O. Sculley, Ralph E. Weikal, Oscar Jaime, Jr., A. E. Redmond, J. S. Chokan, Jr., Ray Knight, Andrew Brygadyr, Summers D. Smith, G. H. Russell, C. R. Wilson, William Adams, Albert Marcus, Leslie Maxwell, Fred Atherton, Thomas P. Jordan, James Nigh, Jr., Joseph Zaichowski, Louis Schmidt, George M. Fleming, Wayne E. Wicks, Ray W. Sahlbach, William Oglesby, Jr., Eric Gertenbach, Harold E. Schrock, J. Carlos Montjoy D., Earl G. Marshall, N. C. Smith, Howard S. Dimmick, Norman Smith, Frank Sekeach, Israel Sinofsky, Louis T. Haws, B. Kashimoto, Luis Diez, Wilbur Croston, George L. Krausse, Warren H. Stark, Charles Hesterman, Albert Pickering, L. F. Gallagher, J. Wendell Partner, H. B. Sargent, Morton D. Meehan, H. E. Wittig, G. H. Matthews, Warren O. Parkinson, Charles W. Bell, Allan B. E. Goetsch, William Beard, Wallace Howe, E. J. Margrie, James Doyle Anatol Kabatoff, Augusto Anea, Lester W. Wright, Joe C. Luehman, John Frederick G. C. Gallagher, H. Kemp, Charles F. Myers, Ward Atherton, John Jeske, Jr., Leonard Moore, A. F. Hairbottle, E. R. Rances, Herman Rup-

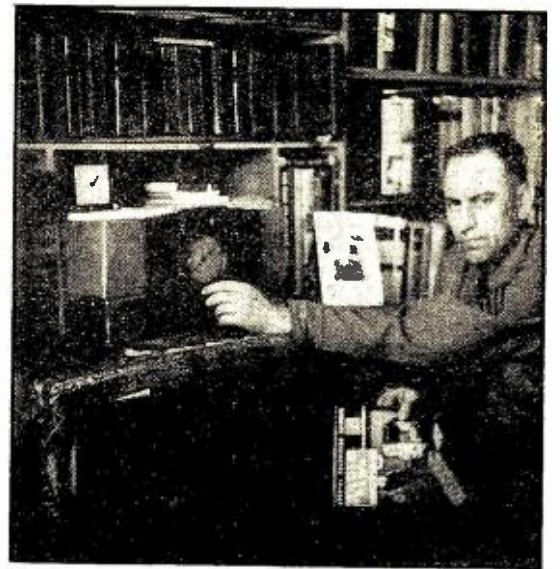

HAWAII ON THE MAP
Lester W. Wright, a short-wave listener of Hawai Upolu Point, greets RADIO NEWS short-wave listeners from that garden island.

pert. Carroll G. Utermahlen, Al Samson, William Turner, Michael Kelly, P. L. Patrick, Chas. Pierce, E. R. Preston, Arthur J. Green, H. Westman, Arthur B. Coover, Orville Khug, E. J. Vassallo, R. C. Messer, Jose Lopez, J. Ralat, Douglas S. Catchim, Thos. Randle.

The H-Beam

(Continued from page 267)

possible to make much better progress by improving the efficiency of the antenna systems we were using than by any other means. He said he was willing to attempt to show what could be done with a simple array, if one of us would assist him in putting one together.

Well, our work started about 3 P.M. By 7 P.M. we were finished, not only with the beam, but with the thirty-five feet of open transmission line, as well. That evening we worked W2DKJ, from our car, while some fifteen miles away. The performance of the beam, in the time which has followed, indicates the soundness of the original idea.

So, here's the dope! Fundamentally, the beam consists of four half-wave elements, in phase, fed by a 450-ohm transmission line of Hi-mho antenna wire, as shown in the photograph. The transmission line should be any even number of half waves long. The cross-member of the H is nothing but a piece of well-seasoned pine, 2-inches square and slightly more than a half-wave length long. In this case, it was 105 inches. The radiators, themselves, turned out to be nothing but four of the Brach type FP-999-W telescopic auto aeri-als, made for fastening to car bumpers, or to apartment-house window casings. These rods extend to a total length of 96½ inches and they are equipped with several feet of very substantial lead-in wire. Also, a heavy steel-angle bracket is supplied with them, which is intended for mounting the pole outside a window. These brackets were bent into right angles, instead of the 45 degree angle with which they come.

A hole was drilled in the center of the cross-member, to allow for the insertion of the pivot, around which the beam would rotate. The four angle brackets were attached in suitable positions, near the upper and lower extremities of the cross-member. Then two National stand-off insulators were attached to the center of the cross-arm, on each side, to provide suitable in-

sulation in the center as well as to make it easy to have the beam rotate without going into the building of too complicated a transmission line.

A short distance from the center a screw-eye was inserted, say about ten inches. About two and a half feet from the center and on each side of the lower surface of the cross-arm, two additional screw-eyes were put in place. The first one was used to hold a tie wire with a transposition block at the end of it to keep the transmission-line away from the pole. A similar arrangement was later attached to the 3 by 3 inch pole itself. The result was a fairly taut line which was flexible enough to permit swinging the cross-arm in any desired direction. It should be remembered that this sort of beam is bi-directional and that it is only necessary to have it rotatable for 90 degrees, to cover every direction. The two screw-eyes, further out on the cross-arm were used to anchor the fish line which was to be used to swing the beam around.

The system used for swinging the beam is simplicity itself. Two fairly long and fairly strong screw-eyes, fitted with porcelain insulators are attached to the mast, a few inches from the top. The fish line, from the screw-eyes, in the bottom of the cross-arm is passed through them and the line is taken to wherever it is to be terminated and that's all there is to it.

At W2DKJ, another and much larger screw-eye is mounted on the window frame, outside the operating shack and the fish line is passed through it and anchored to an awning cleat. Another screw-eye, of the same large variety is used to support a regular automobile mirror.

The mirror is mounted, so that, observed from the window of the shack, the long line of the chimney cuts directly across its center and the position of the beam may be calculated by the angle formed by the chimney line and the cross-arm of the beam.

One of the greatest advantages of this type of unit is weight. It is surprisingly light and can be carried in one hand, with no trouble, whatever. It is a good idea to keep the four elements telescoped until the actual time the beam is to be in place.

Naturally, since W2DKJ used to manu-

facture the transposition blocks we used in making the transmission-line, he would be partial to their use. However, we never realized the ease with which such a line could be made until this one was literally thrown together.

New Courses

Jersey City, N. J.—The School of Communication Engineering, a division of Newton Institute of Applied Science of Jersey City, N. J., has supplemented its two year college-grade Home Study curricula with one year courses in radio engineering and electrical engineering. College credit ratings are available to qualified students; matriculation is limited to High School graduates.

The Service Bench

(Continued from page 292)

available to all members of the R.M.S. We've always figured that a person buying a new radio should have some reasonable assurance that it would be kept in perfect condition for at least twelve months after purchase.

Ghirardi writes to tell us that he is sending copies of his new trouble shooter "gadgets." We'll tell you all about 'em after we have a chance to look them over. We're particularly waiting for the auto-radio, pocket, trouble-shooter gadget. Our car radio has been on the bum now for two months (Is our face red!).

RCA is distributing a novel display neon bulb to dealers through the usual merchandising channels. The lamp glows with the letters RCA, and screws into the usual electric-light socket. The cost is nominal and the lamp consumes only 2-watts of power. Can be used in store interiors to mark the tube department or as general identification. In a window one or more can be employed for "novelty" and to outline the window or certain sales and display features.

How Good Is Your Receiver?

New York, N. Y.—On Sept. 8, John V. L. Hogan, president of WQXR, conducted tests over his station which enabled listeners to determine what range of frequency or pitch could be reproduced by their receivers. The test consisted of a series of audio frequency tones from 20 to 16000 cycles all transmitted at the same volume level. The highest and lowest note still heard clearly gave an index of the quality of the receiver as a reproducing instrument. Similar tests have been held by Mr. Hogan at various times and he collects reports from listeners, thereby obtaining valuable information. If other stations were to follow his example, the industry as a whole would benefit because this would be the first time that incontrovertible proof of quality or the lack of it could be brought home to the average listener.

Tough Treatment

Philadelphia, Pa.—Before a new packing is adopted for export, Philco receivers in their packing cases are rolled down three flights of stairs, dropped to the floor at different angles and generally kicked around. If the sets can stand this punishment—and still sing—they're good enough for export. Special precautions have to be taken against violent handling of goods which are to be carried by camels in the far East and by llamas in South America. Besides the foreign factories, there are now 250 wholesalers or distributors abroad and 16,000 retail dealers. Philco receivers are now sold to 100 nations.

STOP GUESSING, Mister!

Use these 2 Ghirardi **SERVICING BOOKS** They'll tell you **WHAT TO DO** and **HOW TO DO IT!**

I WONDER WHAT TO TRY NEXT?

These two great Ghirardi servicing books will tell you exactly how to handle every servicing problem you'll ever run up against. One book tells you HOW and WHAT—the other supplies quickly all necessary receiver and servicing data WHEN and WHERE you need it—with a regular Supplement Service to keep it up to date at all times. These two books will give you servicing background and theory, all clearly explained in easy-to-understand language. They'll give you the "whys" and "wherefores" of every kind of servicing equipment. They'll give you the most successful repair methods used today. They'll give you receiver "Case Histories," facts—charts—tables, all that indispensable body of material that a serviceman must have today if he is to keep up with all the new developments and do rapid service work. You NEED both of these books on your service bench right now. Send for them at once! Use the coupon below.

EVERY MINUTE YOU DON'T KNOW WHAT TO DO COSTS YOU HARD CASH!

"Modern Radio Servicing" Tells You—

- HOW TO** make the best use of all varieties of servicing instruments—a 420-page section that is a whole book in itself, complete with diagrams and construction data on all types of test equipment.
- HOW TO** apply the latest short-cuts in testing receivers in your own shop.
- HOW TO** repair every type of home or auto-radio receiver, old and new, with many new time-saving methods.
- HOW TO** understand all the complexities of AVC and QAVC circuits.
- HOW TO** trouble-shoot and quickly get rid of all kinds of difficult troubles such as intermittent reception, hum, distortion, etc., etc.
- HOW TO** align and test receivers with Cathode-Ray Oscilloscopes.
- HOW TO** eliminate noise and interference from all sets.
- HOW TO** service auto-radio, all-wave, high-fidelity, and other special types of receivers.

Radio FIELD SERVICE DATA BOOK
436 PAGES
107 ILLUS.

BOTH BOOKS \$6

MODERN RADIO SERVICING
1300 PAGES
706 ILLUS.

The Field Data Book Enables You—

- TO** cut down your servicing time by using the "Case Histories" of home and auto-radio sets it contains. This is the greatest collection of Case Histories in the world—over 1,300 of them!—and more being added all the time in the Supplements.
- TO** align superhets quickly—with the peak I-F alignment data it provides for over 6,000 receivers.
- TO** save time in Auto-Radio servicing by utilizing the big collection of specialized auto-radio data—car ignition system data and electrical wiring diagrams, etc., which it gives for all American cars.
- TO** "trouble-shoot" for every trouble that crops up—in the least possible time.
- TO** save work, worry and money by using the short-cuts you get in the big collection of 25 additional servicing data charts and tables you'll find in this handy time-saver!

HOW TO GET THESE GREAT BOOKS

Fill out the coupon and mail it right now! You don't risk a single penny—your money back if not thoroughly satisfied. You have to have them!

RADIO & TECHNICAL PUBL. CO.
Dept. RN-117, 45 Astor Place, New York

Here is \$6 for my copies of Ghirardi's MODERN RADIO SERVICING & RADIO FIELD SERVICE DATA. (including Jan. & June '37 Supplements to Data Book) postpaid. (Foreign \$6.50)

Please send me Free Circulars describing these books.

NAME.....

ADDRESS.....

MONEY-BACK GUARANTEE!

RADIO ENGINEERING

TRI-STATE COLLEGE

DEGREE IN 2 YEARS.

Complete Radio Engineering Course in 96 weeks. Bachelor of Science Degree. Radio (television, talking pictures and the vast electronic field) offers unusual opportunities for trained radio engineers. Courses also in Civil, Electrical, Mechanical, Chemical, Aeronautical Engineering; Business Administration and Accounting. Low tuition, low living costs. World famous for technical two-year courses. Those who lack high school may make up work. Students from all parts of the world. Enter September, January, March, June. Write for catalog. 16117 College Ave., Angola, Ind.

CRYSTAL HEAD PHONES

SOUND CELL MICROPHONES

Information on request

THE BRUSH DEVELOPMENT CO.
3311 PERKINS AVE • CLEVELAND, OHIO

Utah

Velvet ACTION

VOLUME CONTROLS

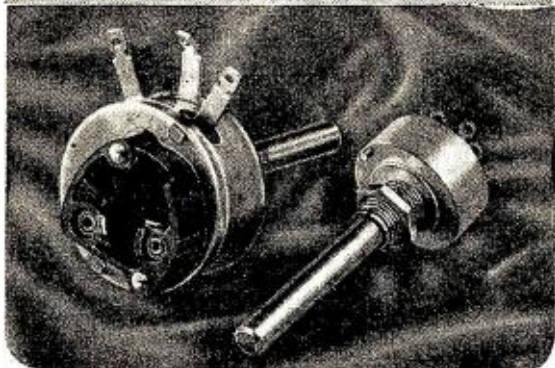

SIMPLIFY REPLACEMENT SERVICE

It's EASY to get parts that give complete satisfaction with less expense and installation labor. Just say "UTAH" to your jobber! Write department RN11 for catalog.

- Vitreous Enamel, Carbon and Wire-wound Fixed Resistances • Variable Resistances • Push-button, Tap and Jack Switches • Jacks and Plugs

CARTER DIVISION

UTAH RADIO PRODUCTS CO.
CHICAGO, U.S.A.
TORONTO, ONTARIO, CANADA
BUENOS AIRES
(Utah Radio Products Co.)
16 YEARS OF LEADERSHIP



Is Radio . . . Just A Job to You?

If you can equip yourself with the necessary training . . . Radio can offer you a future no other industry can. Continuous new developments have created a need for technically trained men, who have kept their knowledge up with Radio's fast pace.

YOU CAN'T BLUFF YOUR WAY

CREI courses are planned only for serious-minded men who know that it takes Training to qualify for and to hold the big jobs and salaries that go with them. Let us suggest the course best suited for you and the easy ways of paying for it.

Write for the CREI
"TESTED PLAN"

Paste the coupon below on a penny post card and receive your copy of this interesting and inspiring booklet.

CAPITOL RADIO
Engineering Institute



MAIL THIS COUPON TODAY!

CAPITOL RADIO ENGINEERING INSTITUTE
Dept. RN-11, 14th & Park Rd., Washington, D. C.
Please send me complete details and illustrated 48-page booklet—"A Tested Plan for a Future in PRACTICAL RADIO ENGINEERING."

Name

Address

City

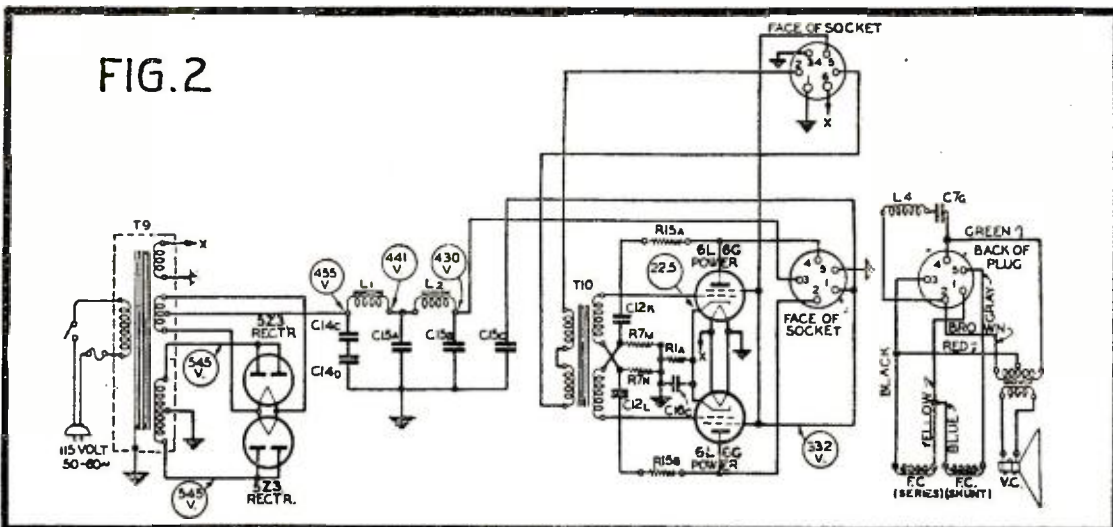

21 Tube Set

(Continued from page 285)

solidly bolted to the flat chassis surface at a number of points to tie the whole assembly into a form mechanically so solid and durable that neither vibration nor strain can loosen any of the delicate parts.

At the left of the bottom view photograph are shown the two stage r.f. amplifiers, 6L7 first detector and 6J7 electron coupled oscillator. These sections are mechanically and electrically almost identical, as they must be to insure identical tuning and circuit tracking for their gang-tuned circuits. Just to the right of the r.f. trimmers visible as circled screws on the lighter colored r.f. transformer sub-assembly plates are the nine separate isolantite wave-change switches. Each mounted in its own shielded room, its r.f. connections are of uniform length, a point so essential to accurate short-wave circuit tracking, while all these nine separate switches are controlled by a single keyed shaft, so that turning its knob changes all separate circuits at once. Above the r.f. wave-band switches are the isolantite tube sockets and at their right is the 4-gang tuning condenser, so located as to provide uniform lengths of grid connections for each circuit. The gang condenser is "floated" upon pure gum rubber, as are the entire tuner and amplifier chasses, to eliminate microphonism.

To the right of the gang condenser is the new "Multiband" i.f. amplifier, AVC, and beat oscillator circuits, audio amplifier, volume expander and separate bass-and-treble tone-control circuits. Front-to-back and end-to-end shield partitions are used here, as in the r.f. circuits, to isolate all sensitive connections for each successive stage of amplification, with by-pass condensers and resistors located upon these shields as well as the chassis itself. The group of ganged isolantite switches visible in this side of the assembly controls selectivity, phono and microphone operation, turn through the choices of combinations of the six dual air-tuned and permanently peaked, not individually variable, i.f. transformers. These, together with the two coupling transformers (for the separate r.f. and i.f. AVC systems) are visible as the eight lighter-colored ovals of their sub-assembly plates located above matching cut-outs in the chasses.

The power amplifier at the extreme right is as rugged and enduringly substantial as the tuner chassis. From top to bottom are seen the large power transformer windings, with iron-core exposed "above deck" for ample ventilation. The filter condensers and their mounting nuts, the two filter chokes, and in the lighter colored rectangular one-piece steel case, the hum-balanced A-metal audio-driver transformer.

Turning to the circuit diagram of Figure 1, a careful study will reveal much of the methods of obtaining the features and performance briefly described in the preceding article. The r.f., first detector and oscillator circuits progress from top-left to lower-left, with the ganged wave-change switches numbered 1 to 9. These select the separate r.f. and oscillator transformers for each of the five wave-bands and are ganged with switch No. 10. This is a very important switch, for it varies the amplification of the two 6K7 second i.f. amplifier in order to maintain over-all sensitivity, uniform on different wave bands.

The ganged switches Nos. 1 to 6, across the top of the diagram, are controlled by the fidelity or selectivity knob. Section No. 1 varies r.f. selectivity by including or dropping from the circuit the first r.f. stage as i.f. selectivity is varied. An examination of the diagram will indicate how the different i.f. transformers, T5, T6, and T4 (for broad high-fidelity) and super-sharp T1, T2, T3 (for extreme selectivity) are selected for the various choices of 4, 8, 12, and 32 kc. selectivity.

The balance of the circuits including the power pack, Figure 2, and their relationships are too involved for simple, non-technical explanation in the brief space here available, but full details will gladly be supplied on inquiry to the writer. No laboratory measurement curves are here presented, but these are available on request. Sensitivity averages 0.4 microvolt absolute from 140 to 6000 kc., 0.2 microvolt from 5800 to 19000 kc. and 1.5 microvolt from 19000 to 70000—enough to give extreme DX reception on a foot of wire for an antenna. Audio response can be anything from flat from 30 to 1600 cycles, to "up" 18db. on bass and "up" 5 db. on treble to "down" 20 to 30 db. on bass or treble, both independently variable. AVC holds all signals from 8 microvolts to over 3 volts constant to 3db. and prevents r.f. overload on strong signals. Inherent noise is extraordinarily low—only 15 milliwatts at sensitivity of 0.2 microvolt absolute, or better than 3-1 signal to noise ratio at a tremendously high sensitivity.

Mobile P. A.

(Continued from page 275)

amplifiers for this purpose, and the latest trend is to build the power pack into the amplifier chassis, providing two power cables. One terminates in storage battery clips, and the other in a standard a.c. plug.

A 20-watt amplifier of this type, familiar to the writer, which also includes a phonograph turn-table which, like the amplifier itself, can be driven either by 6 volts d.c. or 110 volts a.c. is shown in the photograph. The entire assemblage, furthermore, is mounted in a standard P.A. carrying case

to facilitate the process of transferring it from a vehicle to an indoor location—the microphone and speakers unplug and are carried separately. Figure 1 shows the schematic diagram of the amplifier. Equipment of this kind is particularly useful in political campaigns and similar activities in which the talking vehicle serves to gather a crowd and lead them to a central meeting place.

The more elaborate trucks usually carry an operator in addition to the driver but with smaller mobile systems the cost of the extra man may be prohibitive. Hence low-power (15 watt) P.A. amplifiers are often built and mounted much like auto radios, except, of course, that the speaker is external. Controls are mounted on the steering post or dash, while the microphone is a hand-type convenient to the driver.

When it is desired not to mar the roof of an automobile, loudspeakers are often mounted on a false roof which is not bolted to the top but held in place by taut cables fastened under window ledges or elsewhere at the sides of the car. When a speaker or speakers must be pointed forward, and the car driven at relatively high speed, air pressure building up in the baffle may rupture the speaker diaphragm. Short baffles of the metal "dome" type cause less trouble but they offer less protection against rain. The most acceptable compromise is to use such baffles with speakers having weather-proof diaphragms.

Permanent-magnet dynamic speakers are always advisable in the case of battery-operated P.A. systems. The four or eight amperes saved by p.m. speakers may eliminate troublesome battery replacements and the speakers are equally adaptable to a.c. operated apparatus.



Ask Any Old Timer

THE earliest amateurs relied upon precision-built AmerTran Transformers just as the most experienced engineers do today. Many technical improvements, highest quality materials and craftsmanship result in clear, natural amplification under all circumstances. Frequency characteristics are exceptionally uniform; filter types give full inductance with rated d.c. flowing; power units have better than 10% regulation. Consult our Bulletin 1002 for more details. Write:



AMERICAN TRANSFORMER CO.
178 Emmet Street Newark, N. J.



SAVE 52%



1938 DE LUXE 8 TUBE

Never before has such an amazing quality value been offered to you at such a tremendous saving. Just think of it! **52% DISCOUNT!** Incorporates all the newest 1938 features: Powerful Superhet circuit . . . 1 stage R.F. Ampl. on all bands . . . 16 to 560 Meters, 3 bands . . . Visual Tuning . . . 8" Dynamic Speaker . . . A.V.C. . . . Extreme Sensitivity . . . Ultra-Selectivity . . . AC or Battery Models. Other models from 5 to 14 tubes. Write for FREE complete descriptions, prices and 1938 Hetro Catalog. Buy direct! Save 52%!

FOREIGN DISTRIBUTORS—The extensive HETRO line, long manufactured for the Export Trade, offers real money-making opportunities. WRITE or CABLE for Territories still available.

HETRO ELECTRICAL INDUSTRIES, Inc.
4611 Ravenswood Ave., Chicago, Ill., U. S. A.

Send me FREE complete descriptions on all NEW 1938 DeLuxe Hetro models. Also quote your DIRECT FROM THE FACTORY PRICES with savings of 52%, and liberal 10 DAY FREE TRIAL OFFER in U. S. A. only.

Name.....
Address.....

NEW 1938 HETRO RADIO

IMPROVED UP-TO-THE-MINUTE 1937-38 TUBE TESTER

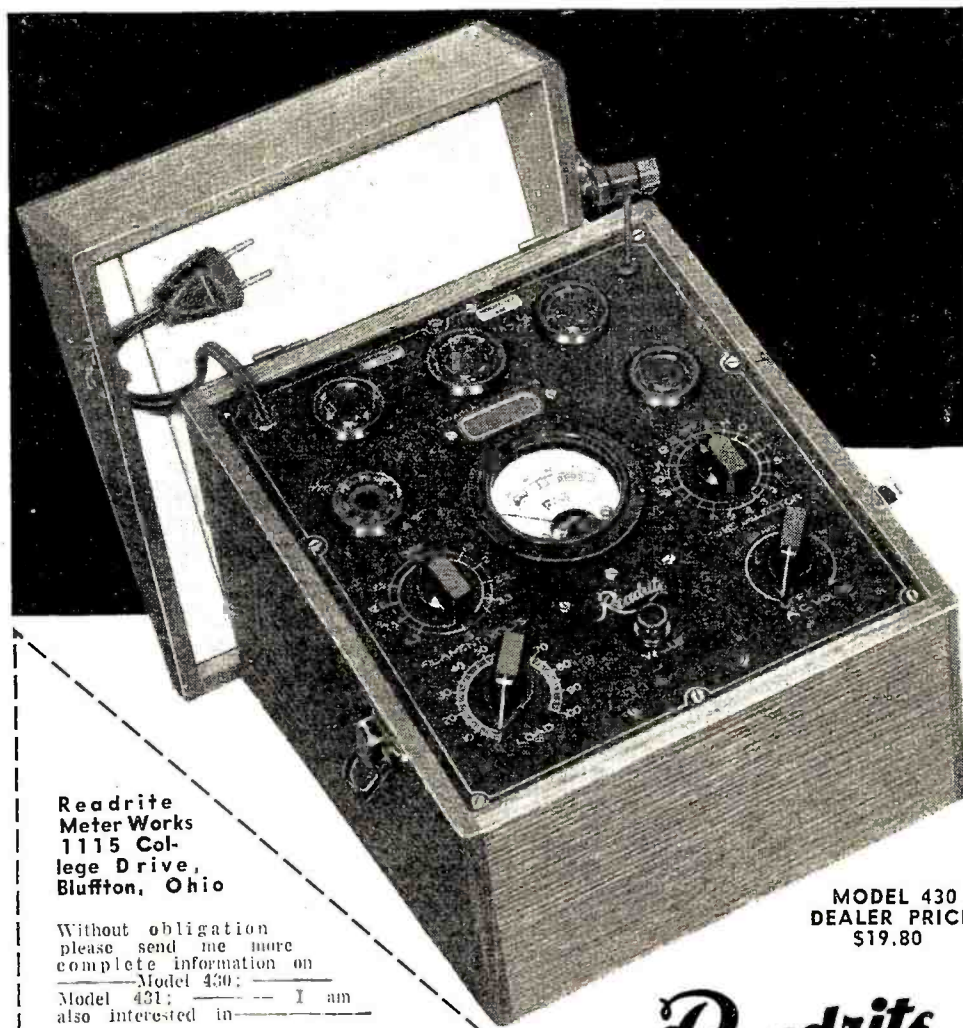

Only
\$1980
for this TUBE TESTER

Positively Checks All Type Radio Tubes According to Data Contained in Latest Recommendation of Tube Engineers.

- Has Line Voltage Adjustment
- Has Leakage and Short Test
- Uses Triplett Direct Reading Instrument (GOOD-BAD Scale)

Five flush type sockets provide for all tubes. The tester operation is very simple and indicates condition of the tube for dealer and customer on Direct Reading (GOOD-BAD) colored scale of Triplett instrument. Will also test for interelement shorts and leakages. Complete in attractive, sturdy, quartered-oak case. Sloping panel of silver and black. Suitable for portable or counter use.

See Our Display—Booth No. 105—Radio Parts Show, New York City

Model 431 same as 430 except has Readrite (GOOD-BAD) Meter.

DEALER PRICE.....\$15.90
SEE YOUR JOBBER WRITE FOR CATALOG



A MODIFIED EMISSION TYPE TESTER . . . APPROVED CIRCUIT

Readrite
Meter Works
1115 College Drive,
Bluffton, Ohio

Without obligation
please send me more
complete information on

Model 430: _____
Model 431: _____ I am
also interested in _____

Name

Address

City..... State.....

.....
**You Couldn't Get Better Performance in a
 SIGNAL GENERATOR**

If You Paid Twice the Price

MODEL 701
\$29.95



And that's no exaggeration—because the workmanship and design embodied in the new Model 701 Signal Generator are just about the last word in engineering. Attenuation from 1 microvolt to 1/2 volt through constant impedance ladder net work 5 steps. Sturdy construction; attractive, modern cabinet. Output for cathode ray modulation. Direct reading 4 1/2" dial. Multicolor frequency bands. From 125 kilocycles to 60 megacycles. Provision for external modulation. Automatic shorting of coils not in use to prevent influence of dead spots, etc. Electrostatically shielded power transformer. Separately shielded coil assembly, attenuator and R.F. circuits.

See your Jobber—
 Write to Dept. N for Catalog

RADIO CITY PRODUCTS CO.
 88 PARK PLACE NEW YORK CITY "DEPEND ON DEPENDABLE"

.....
**Every DX'er Needs This Clock—
 WORLD TIME
 at a glance!**



You're there ON TIME with a World-Wide clock! One quick glance gives you Standard or GMT time, accurately—instantly—for any one of the twenty-four time zones around the world.

Self-starting, 24 hour, genuine Waltham movement. Dials plainly marked for direct reading. For 110 volt, 60 cycle, AC. A beautiful, practical instrument you'll be mighty proud to own. Base removable for flush-mounting in your panel. (Hole size 3 11/16"). Only \$9 net. See your jobber TODAY!

GORDON NAME PLATES **ANTENNA TUNING**

A complete line of 122 everlasting, chromium plated name plates for Transmitter, Sound and Test equipment. Available in two sizes. Write for listing and low prices.

GORDON SPECIALTIES COMPANY
 440 S. Dearborn Street • Chicago, Illinois

RADIO COURSES

RADIO OPERATING: Prepare for Gov't License Exam. ● **RADIO SERVICING:** Including Short Wave ● **AMATEUR CODE** ● **ELECTRONICS** ● **TELEVISION** ●

Day and Evening Classes—Booklet Upon Request

NEW YORK Y.M.C.A. SCHOOLS
 7 W. 63rd Street, New York City

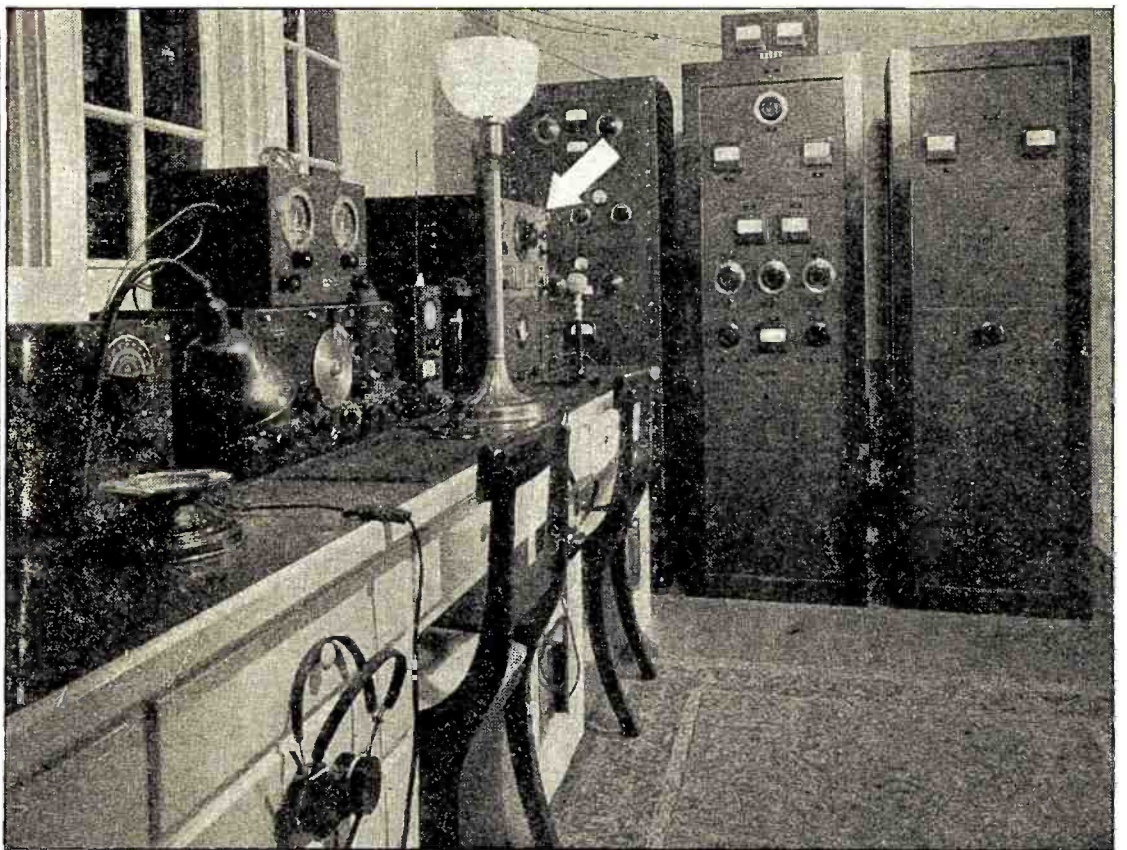

**X'tal Control
 Transmitter**

(Continued from page 284)

efficacy of this type of transformer was demonstrated by rotating it with the amplifier in operation. Ordinary types of transformers show a very marked difference in hum output from the amplifier when this is done. With the PA-136, no change in the low hum-level resulting from installation of this transformer was apparent.

The location of the parts of the speech amplifier section is clearly shown in the rear-view photograph. The output transformer T21 is located at the rear center of the chassis, with the push-pull 6L6s immediately adjacent. T19 and T20 occupy the right end of chassis (rear view) with V16 between. (The PA-52AX is shown instead of the later PA-136). The 4-prong wafer socket, between the two pairs of binding posts on the back edge of the chassis, furnishes output from the amplifier through a 500-ohm line. On the front of the panel the two jacks are for a crystal microphone and the receiver input, while the knob to the lower left of the meter controls the dual gain-control R29-R30.

The second function of the unit is, (B), simplified audio mixing. This is simply the low impedance winding on T19 brought out to the "receiver" jack on the panel. As shown in the diagram, one side of both the jack and the winding is grounded. This winding also has a center tap, so that a double-button microphone could be used by substituting the proper 3-way jack for the "receiver" jack. The total impedance of this winding on T19 is 200 ohms. Low-impedance mixing is preferable to the high-impedance mixing first used because an unused low impedance winding does not introduce any hum into the amplifier output when not used. This is not the case with an unused high-impedance winding.

An external mixing panel, with 200-ohm output to plug into the "receiver" jack on the amplifier panel, is a contemplated addition for the near future. Some interesting mixing operations between, for instance, five and ten meters are possible.

The third function of the Unit N is, (C), volume-level indication. A Triplett type-200 decibel meter kit is employed for

STATION W2JCY-N2JCY

In this photograph is shown at the right the two panels of the 10 and 20-meter transmitter, and at its left 5-meter transmitter. The white arrow points to the master-control unit.

this purpose. The meter, mounted on the panel, reads directly, minus 10 to plus 6 DB. A resistor assembly, mounted and partially wired, is included in the kit. This is the "3-deck" assembly shown mounted under the front center of the chassis. Immediately adjacent is a multiple switch, also furnished with the type-200 kit. This is wired to the meter and the resistor assembly and is controlled from the knob at the lower right of the meter. This meter kit is connected directly across the 500-ohm output from the amplifier, for which impedance the meter is calibrated.

Once the entire transmitter is in proper operating condition the transmitter should be modulated 100 percent from some steady source, as shown on the oscillograph screen. The adjustment knob on the meter kit should then be set so that the meter needle reads somewhere on the upper part of its scale. This reading should then be noted. In future operation of the transmitter this meter reading will denote the 100 percent modulation point of the transmitter and over modulation may be prevented by keeping the pointer to the left of this reading. The location of the meter directly in front of the operator makes continuous monitoring of the percentage of modulation easy.

The fourth function, (D), of the unit is master control of the entire transmitter. The relay control system of the transmitter is extended to Unit N through a 4-wire shielded cable which plugs into a 4-prong wafer socket on the rear chassis edge of Unit N. The entire relay-control system is so designed that a single-pole, single-throw switch, connected as shown in Figure 4, will turn "on and off" the power supplies in both the r.f. and a.f. racks. This switch is the toggle type, shown in the lower center of the panel, directly below the meter.

An extra relay, Rel-8, is incorporated into Unit N. Its position may be seen on the rear-view photograph. This controls the receiver. When the master-control switch is closed this relay opens the B-plus circuit of the receiver, and vice-versa. This further

COIL CHART - FIG. 5				
POSITION	TURNS		FORM	BAND
L9-OSCILLATOR PLATE	18	SPACED	HMLD. SWF - 4	40 METERS
L10-DOUBLER PLATE	8	SPACED	HMLD. SWF - 5	20 METERS
L11-RK25 PLATE	9	SPACED	1½" DIAM. AIR-WOUND	20 METERS
	5	SPACED	1½" DIAM. AIR-WOUND	10 METERS
L12-RK38 PLATE	11	SPACED	GEN. RADIO 677-U	20 METERS
	7	SPACED	2¾" DIAM. AIR-WOUND	10 METERS
L13-HF200'S PLATE-COTO COIL 20TVL				20 METERS
COTO COIL 10TVL WITH TWO TURNS REMOVED				10 METERS

NOTE: AIR-WOUND COILS WOUND WITH #10 ENAMELED WIRE.
 GENERAL RADIO COIL FORMS WOUND WITH #10 ENAMELED WIRE.
 HAMMARLUND FORMS WOUND WITH #22 DSC WIRE.

simplifies operation of the complete station. Once a phone station is raised the only mechanical action necessary by the operator (until the QSO is terminated) is to throw the master-control switch. This provides fast break-in operation when desired. Rel-8 is actually a double-pole, double-throw type of relay, although only one contact and arm are shown in Figure 4. This permits control of other apparatus, when desired, by this same relay.

Keying of the transmitter is also handled through Unit N. A pair of binding posts on the rear of the chassis connect to the key (the other pair of posts being for connection to the receiver B-plus circuit). The key is across wires 1 and 4 of the master-control, as shown in Figure 4. These wires connect back, eventually, across the keying relay Rel-7 which is mounted in the final r.f. Unit, A. Transformer T18, in unit C, provides power for the keying relay as well as the rest of the relay system. It is thus possible to eliminate the usual long keying line to the transmitter proper, and substitute a short line into the back of Unit N. This again simplifies interwiring of the various racks.

Figure 5 is a coil chart. Small deviations from the sizes given may be necessary in another transmitter of this type. L11, the RK25 plate coil is tapped for the grid connection of the RK-38, which is made through blocking condenser C20. As the coil is air wound and spaced, this is easily done by scraping a bit of each turn on the side of the coil toward the RK-38. A flexible wire and clip then permit of best impedance match between the two tubes. The same idea is employed to tap L12 to match the HF-200 grids. In this case two taps must be made, on each side of the electrical center of L12. They should be varied both for best impedance match and equal drive to each of the HF-200 grids. It will be necessary to move these taps a fraction of a turn at a time.

With the transmitter running at 800-watts input sufficient drive to the HF-200's is secured with an input of 1200 volts at about 100 ma. to the RK-38. With the RK-25 doubling to 10 meters and loaded with its excitation tap to about 55 ma. sufficient drive to the RK-38 is secured on ten. Both the RK-25 and RK-38 will run cool at these inputs. The whole secret of running the stages cool at full input to the final stage is in precise adjustment of the excitation taps on L11 and L12.

As mentioned in the first article, three modes of operation are possible on phone. The transmitter may be either operated at the full 800-watts input or a quarter of this figure, 200 watts, by merely throwing the "amp." switch on Unit C. In the third position of this switch the transmitter operates under controlled-carrier conditions. With the particular adjustments used on this transmitter for the controlled-carrier transformer the input of the final amplifier varies from less than 100-watts (with no

modulation) to the full 800 watts.

For 10-meter operation, where QRM is not such a problem as on 20 meters, it is possible to cut out the controlled-carrier operation for DX work if desired. In this way the maximum amount of set noise is knocked out of the distant receiver. As a matter of fact, the full power of the transmitter is seldom necessary on 10 meters. The coupling to the HF-200 stage can be adjusted so that the input to this stage runs at 500-watts or as low as 200 watts input with the "amplifier" switch in the 1000-volt position. This effects a material saving on the light bill.

The best of transmitters is useless without the proper antennas. A rotatable directional beam, one for each band in fact, are desirable. The best of the non-directional antennas can also be used. Those at W2JCY at present are a pair of Johnson Q's. This type of antenna is familiar to most of the amateur fraternity, and are used by a great many of them. They afford a maximum energy transfer from the transmitter to the antenna. The transmission lines used are of the 500-ohm untuned type. This keeps the radiation where it belongs, up in the antenna and not along the feeder wires. The result of this is that no interference to BCL's is encountered.

The degree of coupling to the antenna is adjustable with the variable links on the Coto TVL coils in the final amplifier.

The results with this transmitter this summer at W2JCY have been exceptional. Even while the band has been "closed" it has always been possible to contact stations all over North and South America with nothing less than R7 and mostly R9 reports. Also stations in South Africa, Australia, Europe and Hawaii have been contacted with very gratifying reports.

Parts List For Unit N

- V16—Raytheon, type 6N7 tube
- V17—Raytheon, type 6N7 tube
- V18, V19—Raytheon, type 6L6 tube
- V20—Raytheon, type 5Z3 tube
- 2—octal wafer sockets
- 3—four-prong wafer sockets
- 2—Hammarlund, octal isolantite sockets. type S8
- C32—Cornell-Dubilier, 25-mfd., 50-volt-working, electrolytic condenser
- C34—Cornell-Dubilier, .1, 400-volt-working, paper condenser
- C33—Cornell-Dubilier, 1 mfd., 400-volt-working, paper condenser
- C35, C36—Cornell-Dubilier, dual 8-8 mfd., 450-volt-working, electrolytic filter condenser
- C37—Cornell-Dubilier, 8-mfd., 450-volt-working, electrolytic filter condenser
- R25—Ohiohm, 5 megohm, ½-watt resistor
- R26—Ohiohm, 2,000-ohm, 1-watt resistor
- R27—Ohiohm, 50,000-ohm, 1-watt resistor
- R28—Ohiohm, 100,000-ohm, 1-watt resistor.
- R29—Yaxley, dual 500,000-ohm potentiometer, type NN
- R30—Yaxley, dual 500,000-ohm potentiometer, type NN
- R31—Ohiohm, 2,000-ohm, 1-watt resistor
- R32—Ward Leonard, 10,000-ohm, 50-watt resistor
- R33—Ward Leonard, 200-ohm, 25-watt resistor
- L14—UTC, type PA-48C filter choke
- L15—UTC type PA-40 filter choke

The "WANTED" Kind of High Quality Loud Speaker Performance



CAN BE USED WITH ANY RADIO SET

The Complete Loud Speaker
No Baffle Required

* A Boon to All Amateurs

● HERE FOR THE FIRST TIME is the kind of high quality reproduction preferred by the listener. These Reproducers using the newly developed *Bass Reflex* principle add whole octaves to music, speech is crisp and intelligible, objectionable resonance and boom is eliminated. Extra octaves of low frequency response are added in that range where one seems to feel the "lows" almost before they are heard.

* Amateurs will particularly welcome Model KM Reproducers. When the enclosure is set up the average size receiving set can be placed on top, thus taking up minimum space and doing away with the necessity for a table or stand and a baffle. But the real advantage is, of course, their performance ability. Those who have good receivers but who have never had satisfactory speaker performance will find their requirements more than met in these new Reproducers.

● Model KM, *Peri-Dynamic* Reproducers incorporating the *Bass Reflex* Principle, are sold in kits consisting of knock-down enclosure, speaker and necessary parts for assembly. Only a screwdriver is needed. The outside of the enclosures are lacquered French gray. Model KM is made in four sizes for 8", 10", 12", or 15" speakers. Model KM-12, No. ST-379, is a popular number with the Amateur. The speaker is a Jensen 12-inch PM speaker and the list price of the complete Reproducer is only \$34.25. All Models are available with either Field Coil or Permanent Magnet Fields.

● Model KV. . . . Where speech is the predominant requirement as in a paging system, Jensen offers Model KV (employing the *Jensen Peri-Dynamic* Principle) in kits. Model KV is made in three sizes for 8" speaker, 10" speaker, and 12" speaker. Prices start at \$12.50 for Model KV-8, complete with speaker (no baffle required). JENSEN manufactures a full line of *Peri-Dynamic* Reproducers for every known speaker application and including a line of DeLuxe cabinet models. Sold by Jobbers and Dealers Everywhere.



Jensen Radio Mfg. Company RN-11
6601 S. Laramie Ave., Chicago, Illinois

Please send me FREE 12-page folder, "The Guide to a New Day."

Name

Address

City..... State.....

ECONOMICAL
FLEXIBLE
DEPENDABLE



Type UM—Universal Dry Electrolytic Replacements

Versatile electrolytic capacitors in convenient containers. Will fill the capacity and voltage requirements of innumerable types of condensers. Expensive shopping tours, large and varied condenser stocks completely eliminated by these truly universal electrolytic replacements.

Type UM 100—Rectangular Silver Carton
8-16 Mfd. 200 volts D.C. W.V., 250 volts Peak.
Dual 10 Mfd. volts D.C. W.V., 40 volts Peak.
List.....\$2.15

Type UM 101—Cylindrical Silvered Tube—Spade Mounting
8-16 Mfd. 250 volts D.C. W.V., 300 volts Peak.
Dual 10 Mfd. 25 volts D.C. W.V., 40 volts Peak.
List.....\$2.30

Type UM 102—Cylindrical Metal Container
8-16 Mfd. 250 volts D.C. W.V., 300 volts Peak.
Dual 10 Mfd.—25 volts D.C. W.V., 40 volts Peak.
List.....\$2.40

Described in complete detail in Catalog 151A.
1018 Hamilton Blvd., So. Plainfield, N. J.

CORNELL - DUBILIER
ELECTRIC CORPORATION
South Plainfield, New Jersey

MILLION TUBE TESTER



FEATURES

1. Emission
2. Metal Tubes
3. Shorts Hot
4. Leakage Hot
5. Resistance
6. Electrolytics
7. By-Pass Condensers
8. D'Arsonval Meter

MODEL CP

\$13.95
NET

Model TM—\$16.95 NET

3" square meter and continuous line voltage adjustment.

Deposit and the name of your jobber required on all direct orders.

MILLION RADIO AND TELEVISION LABORATORIES
577 N. UNION ST., CHICAGO, ILL.

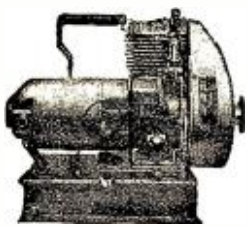

110 VOLTS A. C.

Anytime! Anywhere! With **KATOLIGHT PLANTS**

- 550 watt 110 v. 60 cycle AC. \$59.50
- 400 watt 32 volt DC plant. 78.40
- 15 amp. 12 volt charger. 59.95
- 25 amp. 6 volt charger. 49.95
- AC & DC Generators . . . Rotary Converters. . . 32 Volt 800 Watt Wind Plant. \$141.00

Write For Details.
KATO ENGINEERING CO.,
Mankato, Minnesota, U. S. A.

12" MAGNAVOX

Speakers. All New, in original cartons. Curvilinear cone, 900 ohm field, output to match Single Pentode (42-6F6, etc.) Shipping wt. 8 lbs. **EACH \$2.89**

Write for our New Fall Catalog

ARROW SALES COMPANY
27 S. Jefferson St. Chicago, Ill.

- T19—UTC type PA-136 audio input transformer
- T20—UTC type PA-132 PP interstage transformer
- T21—UTC type VM1 Varimatch output transformer
- T22—UTC type PA-428, 450-0-450 at 250 ma. plus filament windings
- REL—8 Ward Leonard 6-volt, a.c. winding, 4 amp. contact, DPDT relay
- M7—Triplet, type 200 decibel-meter kit, minus 10 to plus 42 DB
- 2—Yaxley, infant jacks, type A-1
- 1—Parmet, 8 3/4 inches by 19 inches, black crackle aluminum panel
- 1—Parmet, 11 inches by 17 inches by 2 1/2 inches, cadmium plated chassis
- 1 pair—Parmet, mounting brackets for above
- 1—Parmet, two-deck cabinet
- 2—SPST, toggle switches
- 4—binding posts with insulating washers
- 1—a.c. outlet
- 2—General Radio, type 637-A knobs, with pointers
- 1—Yaxley, pilot-light, green

Antenna A, B, C's

(Continued from page 264)

positive potentials at the two ends. The electric waves can be considered to move on, and electrons will now reverse their direction (from the center to the ends) from negative to positive as usual, and a deficiency of them (positive voltage) will now be left at the center, while the ends again become negative.

The waves, continuing on, will cause the same conditions to occur, again and again. Each half-wavelength will continue to oscillate and each will be OUT-OF-PHASE with the other. Figure 3A shows the standing waves at one instant and 3B indicates the conditions at an instant half a cycle later.

Similarly, we can have an antenna which is three times as long as a half-wavelength antenna. There would then be three half wavelengths standing on it. Figure 4 illustrates this latter condition. Each half-wavelength added to the length of the wire produces one additional point of high voltage and one of high current. Theoretically, we can have any number of these half-waves standing on the antenna.

As we have seen in the case of the full-wavelength antenna and in the preceding case, if we have at one instant a positive potential on one end of the antenna, the succeeding points of potential on the wire are negative, positive, negative, etc. depending upon how many half-waves are standing on the wire. At a half-cycle later, this condition is reversed. Positive points become negative, etc.

Regarding currents, when the center of one half-wave has a current flow in one direction, the next center will have current flow in the opposite direction, etc.

Figure 6 is a good analogy of an antenna working at a harmonic. Successive instants are shown. Plus and minus signs indicate "positive potential" and "negative potential" and the arrows indicate direction of pendulum travel.

Marconi Antennas

All the above antennae considered are of the Hertz type, because the ground plays no part in the function of the radiator.

A diagram of a Marconi working at three times its fundamental frequency is shown (Figure 7). There are three quarter-waves standing on it. The antenna is always exactly half the length of a Hertz for a given frequency. It has an odd number of quarter-waves standing as against an even number for the Hertz. The point of ground connection is a point of low voltage and high current. An r.f. ammeter will show its highest value at this point.

Up to this point we have assumed that when the term half wavelength was used, it indicated this exact length. However, it

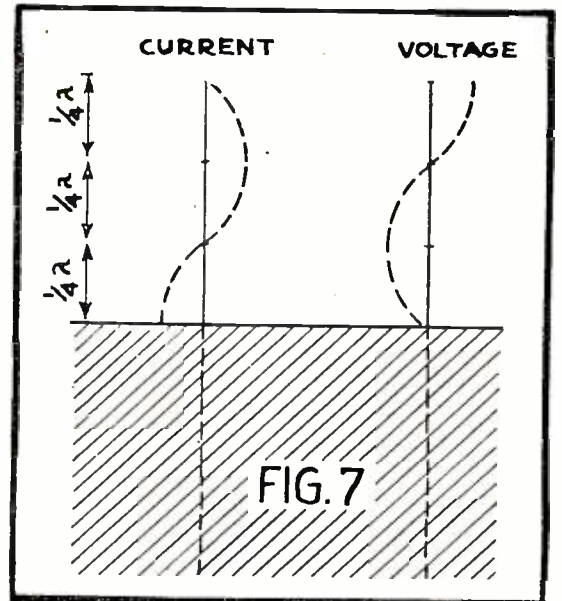

FIG. 7

is found in practice that due to various factors the effective length of the antenna is slightly increased. To make up for this, we must use a correction factor as follows: Below 20 meters we use the factor 94% between 20 and 100 meters, we use 95% while above 100 meters we multiply an actual half-wavelength by 96%.

A formula for the length of an antenna in feet for a certain frequency in megacycles can be developed as follows:

$$\text{Length (ft.)} = \frac{300}{\text{mc.}} \times 3.28 \times K \text{ or } \frac{492}{\text{mc.}} \times K$$

K is the correction factor as explained in the previous paragraph. There are 3.28 feet in a meter. We divide by two because we wish to find the length of a half-wave. This applies to a Hertz. Since in a Marconi only half its effective length is above ground, we must again divide the above by two for the latter type.

11-Tube Set

(Continued from page 280)

the top of the broadcast band down to below 5-meters.

These ranges are selected by means of 6-position knob immediately below the main tuning dial.

There are two tuning controls, one for main tuning and the other for band-spreading. These take the form of large wheels located at either side of the main tuning dial.

The other controls, reading down the left hand side, across the bottom, and up the right hand side of the panel, consist of the tone control and a.c. switch; the a.v.c. off-on switch; the beat-frequency oscillator injector (which permits the output voltage of the beat-frequency oscillator to be adjusted to any desired level); headphone jack; send-receive switch; audio gain control; band selector; r.f. gain control; i.f. band-width switch for selecting the sharp or broad positions; crystal phasing control; crystal out-in switch; and the beat-frequency pitch control.

To the left of the main dial is the signal level indicator or "S" meter. This is calibrated in terms of "S" signals from 0 to 9-plus so that carrier strength reports may be read directly from this scale.

As to performance, curves are presented in Figures 1, 2 and 3 showing measurements made by an independent laboratory covering the sensitivity, selectivity and fidelity.

The sensitivity curves, Figure 1, represent the signal voltage required to equal noise. Measurements made without regard to noise would of course look better on paper but would be meaningless as it is

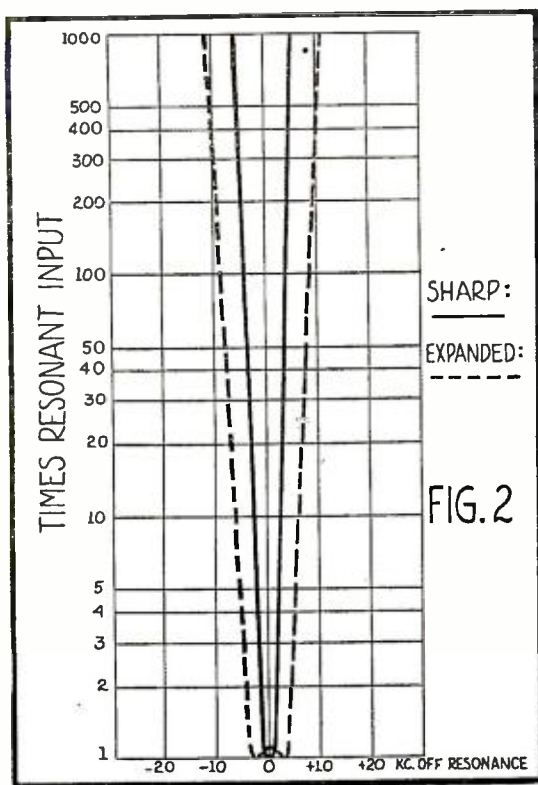
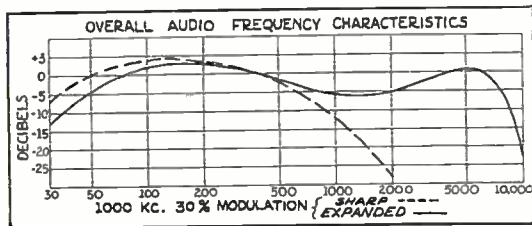

FIG. 2

the usable sensitivity of a receiver that counts. It will be noted that from 1600 kilocycles to 26 megacycles the usable sensitivity as indicated by these curves is better than one microvolt. In the broadcast band it is better than three microvolts and in the ultra-high frequency band drops to a value of approximately ten microvolts.

Figure 2 shows the selectivity. The solid inner curve was measured with the i.f. band-width switch in the sharp position, or the position of maximum selectivity. The broken line represents the expanded position. These curves are self-explanatory and therefore do not require a written description beyond the comment that this is one communications type receiver which provides really fine quality reproduction when used in the wide-band position.



Preliminary tests of this SX-16 Sky rider indicate that the manufacturer has been highly successful in his objective in producing a receiver to meet all DX, amateur and short-wave requirements at a price low enough to keep it within the reach of a large body of radio enthusiasts.

The W4EDD Beam

(Continued from page 267)

the radiator total length is 96 percent and the director total length is 86 percent. Tests made between W4EDD at Coral Gables, Florida and W2JCY at North Pelham, New York, have proven without a doubt the tremendous efficiency of this 10-meter antenna for consistent contacts have been made between these two stations all summer long and the W4EDD antenna has made contact possible between these two stations many times when there were no other fourth district stations that could be heard in North Pelham. The gain of this antenna as calculated from the standpoint of input signal strengths in microvolts indicates at the receiving station a power gain of more than 6:1 over an ordinary half-wave antenna.

In these days of low power transmission

on 5-meters beam antennas such as this modified Yagi offer a direct solution to interference and distant transmission problems and where the station owner has adequate room for such an insulation the W4EDD beam is clearly indicated.

The "Double Diamond"

(Continued from page 266)

In the installation at W2HWX, the whole unit rotates by means of a motor and an indicating device, electrically operated in the radio shack, shows on a chart the direction of transmission and reception. In the author's opinion, after cooperating with many tests on this antenna, it is far superior to most of the so-called beams that he has had the opportunity to test. Experimentally inclined 5-meter DX'ers who wish to do some real work on long-distance transmission and reception with a minimum of interference will do well to give this beam very serious attention.

10-160 Meter Transmitter

(Continued from page 281)

peak audio voltage of approximately 75 volts for complete modulation. This is adequately supplied by the amplifier-modulator unit. It is connected to the transmitter in series with the external suppressor battery as described above.

More than sufficient audio gain is available in the amplifier to permit the use of any standard type of microphone. It is particularly well adapted for a crystal type. The 6J7, 6C5 and 6F6 are resistance coupled and feed to the modulator through a modulation transformer.

Volume of the audio amplifier is controlled by a "gain" control on the front panel. One interesting feature is the use of a quarter-watt neon lamp connected across the secondary of the modulation transformer to serve as a voltage indicator. This will show the presence of the modulation voltage.

In tests made with the transmitter on the 40 meter c.w. band it proved to be an effective medium powered transmitter despite the severe QRM that exists on that band.

Excellent results were obtained on the 20-meter c.w. band. Among the stations worked were G2LC, G5YH, HI5X and a number of American stations on the fifth and sixth districts. The antenna used on this band was a half-wave doublet.

Tests with modulation on the 20 meter band were made during an evening of heavy QRM and considering the conditions and the small carrier good results were obtained. Station CO2WZ was raised on 'phone, but he had difficulty identifying our call due to "very heavy QRM" so the QSO was not satisfactory. He stated, however, that the signal seemed to have a strong carrier but the modulation interference from a W3 on the same frequency made it practically impossible to have a satisfactory QSO. Several local stations were worked on 20 meter 'phone, and all reported the signal excellent from a quality and signal strength standpoint.

From past experience, it has been found when a good antenna is used it is possible to work through the congestion on the 75 and 160 meter bands even with a 20-watt carrier.

SEND TODAY FOR DETAILS OF MY "PAY AFTER GRADUATION" PLAN

Prepare now for big opportunities in the world's most fascinating profession. Get a training in the Coyne Shops in a practical way that will give you your start in this great field... I offer you the opportunity to finance your training. Send now for details of my "Pay After Graduation" Plan and Big FREE illustrated book with all the facts about Coyne training. Mail Coupon today for details.

REAL OPPORTUNITIES For the Radio Trained Man

Prepare for a job as Designer, Inspector and Tester—as Radio Salesman and in Service and Installation—as Operator or Manager of a Broadcasting Station—as Wireless Operator on a Ship or Airplane—as a Talking Picture or Sound Technician—HUNDREDS OF Opportunities for fascinating, WELL PAID JOBS!

12 WEEKS' SHOP TRAINING No Experience or Advanced Education Needed

We don't teach by book study. You get your training at Coyne in Chicago by ACTUAL WORK on a great outlay of Radio, Broadcasting, Television, Talking Picture and Code equipment. And because we cut out useless theory, you get a practical training in 12 weeks. That's why you don't need advanced education or previous experience.

TALKING PICTURES—TELEVISION

Talking Pictures and address systems offer great opportunities to trained men. Television is the great new branch of Radio now developing very rapidly. Be ready for your chance in Television. At Coyne you are trained on real Talking Picture and Television equipment.

ELECTRIC REFRIGERATION AND AIR CONDITIONING Included at NO EXTRA COST

So our graduates may have an all around training which increases their earning capacity, we are including for a short time a training in Electric Refrigeration and Air Conditioning. Here is your chance to get a practical training in this great new field at no extra cost.

MANY EARN WHILE LEARNING Employment Help After Graduation

When you enroll at Coyne you get a Life Scholarship. You get Free Employment Service for Life after Graduation. If you need part time work to help pay living expenses we will help you get it. Coyne is 39 years old. Coyne training is tested—you can find out everything about our course and "Pay After Graduation" Plan. Just Mail Coupon for My BIG FREE RADIO BOOK.



H. C. Lewis

SEND NOW FOR FULL DETAILS!

H. C. LEWIS, President, Coyne Electrical & Radio School, 500 S. Paulina St., Dept. 87-3K, Chicago, Ill. Dear Mr. Lewis:—Send me your big Free Radio Book and all details of your Special Tuition Offer—and about your "Pay After Graduation" Plan.

Name.....
Address.....
City.....State.....

Aladdin
REG. U.S. PAT. OFF.

NEW!

TRIPLE TUNED I-F TRANSFORMERS

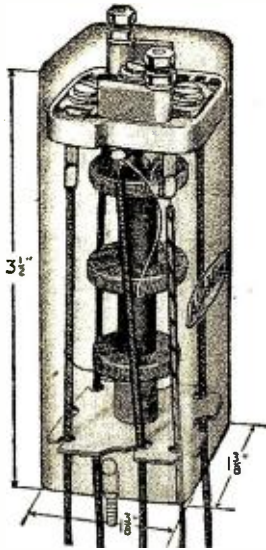

"Years ahead" in design, these new I-F's bring you many important advantages not found in other types. Extremely compact . . . only 1 3/8" square by 3 1/2" high. All trimming condensers are tuned from top of shield. Easy alignment: no cathode ray oscilloscope necessary. High adjacent channel rejection 30 kc. wide at 20 times down. Broad flat top—8 kc. wide. Send for FREE technical data.

ALADDIN RADIO INDUSTRIES, INC.
466n W. Superior Street, Chicago, Ill.

Licensee of Johnson Laboratories, Inc.

These devices manufactured under one or more of the following U. S. Letters Patents: 1,837,580 1,940,228 1,978,568 1,978,399 1,978,600 1,982,889 1,983,690 1,997,435 2,002,500 2,022,590 2,005,205 2,018,628 2,022,554 2,032,580 2,032,914 2,036,439 2,051,012 2,082,395 2,082,587 2,082,588 2,082,589. Other patents pending.

THEY'LL STAND THE OVERLOADS!

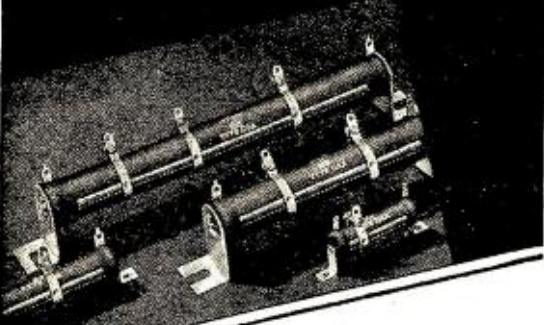

"IRC Cement Coated FOR DURABILITY"

Everywhere you'll find IRC Power Wire Wound Resistors specified for the most exacting industrial, aircraft, broadcasting, naval and commercial communications. They dissipate heat more rapidly; are built to stand heavy overloads, moisture, even salt water immersion—and have the added advantage of extreme mechanical strength. . . . A complete line of fixed and adjustable types for every need. Write for IRC Resistor Catalog No. 42.

INTERNATIONAL RESISTANCE CO.
401 N. Broad St.
Philadelphia, Pa.



TRANSMITTING POWER WIRE WOUNDS

Black Light

(Continued from page 269)

of the high-voltage coil must go to one side of the 115-volt primary winding. The 2 1/2-volt filament connects to the other side of the primary. Tie one side of the 5-volt winding to the free 2 1/2-volt terminal, and temporarily place the auto bulb across the outside terminals of the two filament sources, in series.

The light source utilizes a 21-candle-power, 6/8-volt single-contact auto headlight bulb. A simple double convex lens projects a beam of light from the lamp filament to the p.e. cell surface. Behind the lens provision is made to mount the infra-red filter glass, in thin sheet metal guides, or slides.

Details of the light source box are drawn in Figure 3. The box must be ventilated if the bulb is to operate at reasonable temperatures and not burn out prematurely. The vent holes are covered with baffle plates to prevent the light from leaking out, and the entire inside surface of the box should be painted a flat black.

The type of unit used for sounding the alarm may be the subject of considerable leeway. It may be a buzzer, as shown in one of the photographs, or an ordinary doorbell.

The infra-red beam will operate over distances, between light source and p.e. cell, up to 20 feet.

To put the system in operation, drop a piece of bakelite or cardboard tubing over the 'eye' so as to cut off all light (as in one of the photographs). Connect a wire temporarily across the front contacts of the relay, from X to X on the circuit diagram. Carefully check all the other wiring and connections, and if satisfactory turn on the 115-volt a.c. supply. The buzzer will sound and probably will continue to sound until the adjustments are completed. Line up the light source so that it points at the p.e.-cell unit, and focus the lamp for maximum brilliancy on the cell. Then slip the filter glass into place behind the lens. Go over to the p.e.-cell unit and turn the potentiometer to make the buzzer stop ringing. Then turn the knob back just slightly past the point where the buzzer again starts. If, at no setting of the potentiometer will be buzzer stop sounding, then the lead going to the high-voltage terminal on the transformer must be transferred to the terminal on the other side of the center tap. Take the covering from the p.e. cell and the relay will pull up and stop the buzzer. Then remove the temporary jumper from X-X and the alarm is ready to operate.

When the invisible beam is interrupted momentarily the relay will drop out and, because it breaks its own circuit, will remain open until manually closed. As long as it is open the alarm will ring through the connection to the back contact. A small hole may be cut in the box opposite the relay armature through which a stick can be pushed to reset the relay.

Parts List

- Lamp—21-c.p., 6-volt, single contact automobile bulb
- Lens—Double convex, 1 1/2-in. dia., 3 1/2-in. focal length (Bausch & Lomb No. 81 23-30-012, price 50c)
- Filter—Infra-red filter glass, 2-in. square (Fish Schurman Corp., N.Y.C., Jena RG-9 optical filter, blown quality, 50-m.m. square, price \$1.50).
- V1—RCA type 868 photo-electric cell
- V2—RCA type 885 gaseous triode vacuum tube
- T—Stancor half-shell 4-tube midgcet radio transformer Primary 115-v. 60-cycles, secondary 5-v., 2.5-v. C.T., Hi-v. C.T.
- R—Relay made from auto generator cutout, No. 36 enamel copper wire winding, resistance approx. 300 ohms, pull-in current approx. 25

milliamperes, operating current approx. 50 milliamperes.

- C1—1 mfd., 400-volt, paper
- C2—20 mfd., 50-volt tubular electrolytic
- R1—Metallized resistor, 1-watt, 150,000 ohms
- R2—Wire wound volume control, to 20,000 ohms
- R3—Metallized resistor, 1-watt, 2 megohms
- R4—Metallized resistor, 1-watt, 75,000 ohms
- R5—Metallized resistor, 1-watt, 25,000 ohms
- R6—Wire-wound resistor, 10-watt, 600 ohms
- 1 Stationary distributor point and mounting, from Ford Model A distributor
- 1 buzzer or bell for alarm
- 1 box for photo-electric cell unit, 7 5/8 x 4 1/2 x 3 inches
- 1 box for light-source unit as shown in sketch, 4 7/16 x 3 3/4 x 2 inches
- 1 Wafer socket, 4 prong
- 1 Wafer socket, 5 prong
- 1 Bayonet-type automobile lamp socket, single contact

Movie Sound

(Continued from page 276)

1800 square feet, of the total floor area of 6,000 square feet is covered with carpet having an absorption of 0.15 per square foot, which amounts to 270 units. The uncovered part, 4200 square feet of concrete has 0.015 units absorption per square foot, or a total of 63 units. The total absorption of 800 seats at 3 units each would be 2400 units. However, our calculations are to be made on bases of half-audience and full audience. For the half-audience condition the 400 seats remaining vacant represent 1200 units, and the audience of 400 at an absorption of 4.7 per person represents 1880 units.

For the full audience, the seat absorption is replaced by the absorption of 800 individuals at 4.7 units each, or 3760 units.

Proceeding, we add together the 535 units of wall and ceiling absorption, the 270 units of carpet absorption, the 63 units of concrete floor absorption, and, for half-audience, 1200 units for vacant seats and 1880 units for the audience, arriving, at 3948 units.

For the full audience we add together the 535, 270, and 63 units for the walls, etc., and the absorption for the full audience, 3760. These amount to 4628.

These values, 3948 and 4628, are substituted for A in the formula for the reverberation time. When the calculation is carried out we find that for half-audience the reverberation time will be 2.3 seconds and for full audience it will be 1.94 seconds. Both of these exceed the acceptable limits for a 200,000 cubic foot room—the nearest value to our assumed 180,000 cubic feet.

In order to bring the reverberation time for half-audience within the acceptable limit of 2.0 seconds it will be necessary to place enough acoustic material around the auditorium to increase the quantity A from 3948 to at least 4500; and for full audience, A must be increased to 5290.

Manufacturers who supply the various acoustic materials rate them by the absorption coefficient per square foot at various frequencies from 128 cycles to 4096 cycles. The generally accepted practice is to use the absorption at 512 cycles.

It was determined above that, for half-audience, the total absorption had to be increased from 3948 to 4500, or 552 units. Selecting a material having an absorption of 0.2 units per square foot, at 512 cycles this coefficient per square foot divided into the necessary increase of 552 units indicates that 2760 square feet of material will be necessary.

For full audience the increase in absorption from 4628 units to 5290 is 662 units. Dividing 662 by 0.2, we arrive at 3310 square feet of material.

There is no hard and fast rule available to determine which of these amounts of material should actually be used. It will depend, among other things, upon how the show is run.



The "Goyn" Beam

(Continued from page 266)

four radiators arranged in a line, one of which doesn't show at the left of the photograph. There are four reflectors in a line, all vertical. The beam is unidirectional toward the radiator side and transmits, therefore, broadside. It is believed to have a power gain of between four and six.

The four radiators are fed with a Hertz transmission line, tuned with a tuning unit, held out on a bracket arm as seen in the photograph. The feeders between the two outside radiator sections are crossed over, while the two middle radiators are fed at the exact center of the transmission line by the main feeders running down the mast to the transmitter. This provides for all the half-wave radiators being in phase.

The various supporting sections of the frame are fastened together with bolts and the whole antenna can be taken down and folded up. W3AC has been able, using this antenna, to work consistently all the way up and down the northern part of the Atlantic seaboard.

Push-button Tuning

(Continued from page 277)

reverse its direction of rotation so that it goes back to the station again with slightly less speed, until the system comes to rest with the insulated segment under the contact finger.

The push-button panel with 10 buttons and the accompanying windows or spaces for the station call letters, measures 2 by 4½ inches allowing plenty of finger room between buttons. Instead of using the customary round push-buttons they are of an edge-wise piano-key arrangement. A sheet of station call letters is provided so that the user can label the individual buttons.

The set covers six tuning ranges, accurately calibrated on a 9-inch dial. The overall frequency range, 125 kilocycles to 20 megacycles, is divided as follows: 550 to 1500 kc., 10 to 20 mc., 5.2 to 10.4 mc., 2.7 to 5.4 mc., 1.5 to 3 mc. and 125 to 350 kc.

The 20 tubes are utilized as follows: one 6K7G r.f. amplifier, a 6L7G mixer, a 6C5G oscillator, two 6K7G's in two i.f. stages, 6H6G second detector and automatic volume control, 6C5G first a.f., 6C5G phase inverter, four 6V6G's in a push-pull-parallel output stage for 25 watts undistorted power, a 6J7G, 6K7G, and a 6H6G employed respectively, as the control, amplifier, and rectifier tubes in the automatic frequency-control circuit, a 6C5G for the color-ray tuning-eye circuit, a 6C5G

and 6R7G for the expander circuit and two 80's as rectifiers in the power supply. It will be noted that all the tubes are of the octal glass type except the 80 rectifiers.

The 9-inch dial provides mechanical band-spread which is especially effective on the broadcast and the popular short-wave ranges. When tuning on the broadcast band only this section of the dial scale is illuminated and with a flip of the wave-band switch the short-wave bands and the long-wave range are projected on the dial scale. Another feature includes an automatic-frequency-control circuit which automatically adjusts the tuning for any slight deviation that might occur.

A word in reference to the four controls, the top-left knob is the manual tuning control and under this is a lever for wave-band switching. The top, right control is for volume adjustment and the bottom, left lever is the tone control and expander circuit switch for both motorized and manual tuning.

The chassis supplied RADIO NEWS for the operating tests is equipped with the "Trio-Sonic" electro-dynamic reproducers, one 12-inch bass unit and two 6-inch high-frequency speakers. This triple-speaker combination, connected to the output stage with its four beam power tubes, delivers quality of reproduction distinctly life-like and with the volume expander circuit cut-in there is a real treat for music lovers. The preliminary operating tests indicate selectivity and sensitivity well above average on all bands. The results of the tests will be described in detail next month.

The "Ham" Shack

(Continued from page 279)

structed, but there are a few combinations that stand out because of their efficiency and stability. The tests show for 160 and 75 meter operation the 47 and 2A5 or similar tubes are stable oscillators capable of delivering around ten watts to a buffer stage. However, these tubes become somewhat unstable when used with 40 and 20 meter crystals unless very carefully adjusted. Other combinations seem more practical for higher-frequency crystals.

Of course, it follows that tubes that work well with higher frequency crystals will perform well at lower frequencies. One of the best all around crystal oscillator units is the so-called "Les-tet" designed by Frank Lester. In Lester's original unit, a 6C5 is used as the crystal oscillator followed by a 6L6. There have been other combinations suggested using the same principle but with different output tubes. Among these is the 6C5-802 unit used in the low-powered transmitter described in this department last month.

The "Les-tet" unit is adaptable to all frequencies for which crystals may be had. This includes 20-meter crystals. Tests have shown that this oscillator unit is extremely "easy" on crystals and in some instances where crystals have been known to "kick out" in other oscillators, this habit has not been noticed with the same crystals in this latter circuit. Because of the design of the 6C5 the crystal current is very low. Further, when this tube is used to drive a tube of the beam-power type such as the 6L6 or 807, small output is needed. Consequently small input is required on the oscillator tube (about 12 milliamperes at 250 volts). This induces very little heating with resultant freedom of drift.

An oscillator unit of this type is particularly desirable for high-frequency operation, i.e. 20, 10 and 5 meters. The 6C5 is very "easy" on 20-meter crystals, and by using the unit as a doubler, enough power may



Now THE NEW Console "SUPER-PRO"

HAMMARLUND now presents the internationally famous "Super-Pro" 16 tube professional receiver in a new, distinctively designed, high fidelity console. The professional performance provided by this precision instrument, heretofore available only in a table model or rack and panel style, thus now can be enjoyed by those at home.

The console, in addition to being exceptionally attractive for it is of the classic-modern style, with burl, matched and oriental walnut artistically blended, also has remarkable acoustical properties painstakingly engineered to match the other advanced features of the "Super-Pro" receiver. This striking acoustical performance is achieved with a new type of sealed sound chamber and a special 15" high-fidelity speaker.

The receiver itself is identical to the table model "Super-Pro" with such outstanding features as two stages of R.F. on all bands, affording a sensitivity of 0.85 microvolt, and image rejection ratios from 150 to 1 on 10 meters to 175,000 to 1 on 300 meters! Other "Super-Pro" features are calibrated 3 to 16 kc. band-width control, as well as calibrated audio and sensitivity controls; noiseless and trouble free cam switch; direct tuning accurate to within ½%; three audio stages; separate electrical band spread control; self contained tuning unit; A. V. C.-Manual switch; phone jack; models for 7½ to 240, 15 to 560, and 15 to 2000 meters, etc.

You will be proud to own this new "Super-Pro" console model! Write Department RN-11 for further details. Mail coupon below.

HAMMARLUND MFG. CO., INC. RN-11
424-438 W. 33 St., N. Y. City

Please mail me "Super-Pro" console bulletin.

Name.....

Address.....

City..... State.....



HAMMARLUND



- ★ Latest version of popular type molded mica capacitor. Screw terminals. Tapered sides.
- ★ Capacity and test voltage stamped on each unit.
- ★ A superior high-voltage high-frequency capacitor. 1000 to 10,000 D.C. test voltage. .00005 to .05 mfd.

New CATALOG....

Just issued. 32 pages. Many new items in addition to already remarkably complete AEROVOX line. Ask local supplier or write us for your copy.



NEW NATIONAL RECEIVERS

NC-80X Receiver—Ten tubes, crystal filter, controllable selectivity from 200 to 10,000 cycles, automatic coil shifting, complete frequency coverage from 915 to 690 meters, self contained power pack, PM speaker, calibrated mechanical bandspread.

NC-81X Receiver—Same as above, but a strictly amateur-band model, providing extreme calibrated bandspread on the amateur bands, with no frequency coverage between bands.

Either above receiver complete with tubes, crystal and speaker chassis.

AMATEUR PRICE \$88.00 NET COMPLETE

Write for our 1937 catalog

CAMERADIO

963 LIBERTY AVE. 30 TWELFTH ST. PITTSBURGH, PA. WHEELING, W. VA. Established 1919

IF IT'S TOUGH - DON'T CUSS Turn To RADIO-KINK-AIDS

Practical Repairs For Over 3000 Hard-To-Fix Radios.

Just pull out the card corresponding to the name and model of the set you are repairing, and there you have listed the service troubles found in that radio and how to fix them. Yes, it's as simple as that.



ONLY \$1.95

COMPLETE WITH METAL CABINET

FREE Write for Bulletin RN-11 and Sample Card

AKRAD PRODUCTS CO. 362 WOOSTER AVE Akron, O.

Tear out this ad, write your Name and Address in the margin, send \$1.95 and we will send outfit at once.

LES Correspondence Courses In RADIO and ELECTRICAL ENGINEERING

ELECTRICAL ENGINEERING Get good grasp of wide electrical field. Prepare yourself, at Low Cost, for secure future. Modern course. So simplified anyone can understand quickly.

RADIO ENGINEERING Extra fine course in radio. public address, photo-electric work. Trains you to be super-service man, real vacuum tube technician. Experimental kits furnished. Diploma on completion. Tuition, ONLY \$25, either course. Deferred payment plan available.

FREE! Send name quick for free copies of school catalogs, student magazines, complete details. **SEND NOW!** LINCOLN ENGINEERING SCHOOL, Box 931-48, Lincoln, Nebr.

be obtained a high-frequency triode stage at 10 meters and as a quadrupler sufficient power is obtained for an 807 at 5 meters. However, greater efficiency at 56 megacycles may be obtained by using an additional doubler tube rather than quadrupling in the oscillator unit. The output from such a unit will vary of course with input, but under normal conditions as much as 25 watts may be obtained.

Another popular oscillator unit makes use of the twin-triode types of tubes such as the 6A6, RK34 and 53. Here one triode is used as the oscillator and the second triode as a frequency multiplier. Because these tubes are rather high-mu, it is possible to use voltages up to about 350 without endangering the crystal. These tubes make exceptionally fine exciter units. An arrangement of this type will drive a buffer stage of the 210 type with ease at 20 meters and, as a quadrupler, a beam tube as buffer.

Of the recently introduced pentodes, the 807 is perhaps the best crystal oscillator tube, from the standpoint of power output. It is in the same category as the 6L6 and because of its high output may be operated conservatively to obtain a high order of stability. Another oscillator tube is the 802. In addition, this tube will function well in a "tri-tet" circuit.

As for the power pentodes, it is advisable not to use tubes larger than those in the so-called 50-watt classification. These include the RK-20 and 805. By using slightly-reduced plate voltage, tubes of this type will work well as crystal oscillators. Larger pentodes, however, require the use of a small-capacity condenser, connected between the plate and grid to induce added feedback. If they are not carefully adjusted with reduced voltage, they are apt to run a high crystal current which will cause it to fracture.

The advantage in using a power pentode oscillator is that it will provide a stable output of medium power from a single tube unit. It will function well as a compact portable transmitter. Its portability is helped by the fact only one power supply is needed. Another advantage is that it affords a crystal-controlled transmitter for the amateur of limited means. On the other hand, as previously pointed out, it is a simple matter to construct a triode oscillator of the type previously mentioned and if the transmitter is to be used in a fixed station, the transmitter size and cost will be increased only slightly.

What's New in Radio

(Continued from page 265)

porates a reference point system of analysis, whereby all resistance, voltage, and current measurements can be taken between any two-tube elements or between any tube element and ground without the necessity of removing the chassis from the cabinet. It has provisions for measuring voltages

(Turn to page 320)

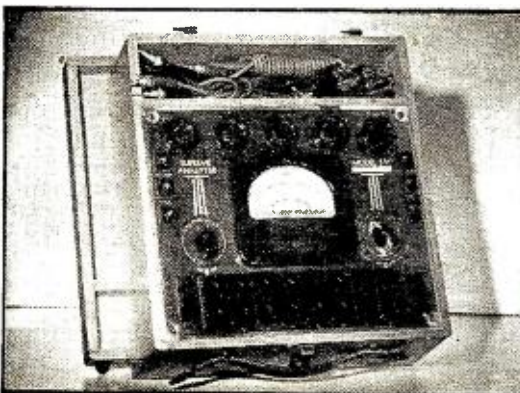

CIVIL SERVICE HANDBOOK

Complete Home Study Courses for Federal, State, and City Civil Service Positions

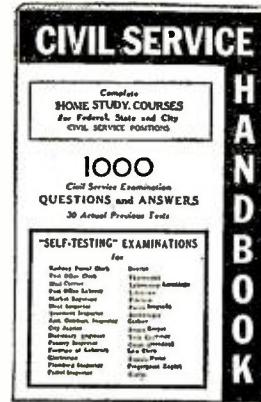

By W. A. Brooks

A comprehensive Civil Service Handbook containing 1000 Questions and Answers of former tests. Also 30 actual previous "self-testing" examinations (with correct replies) for such positions as postal clerk, letter carrier, fireman, policeman, sergeant, bookkeeper, clerk, electrician, librarian, etc. It shows the mistakes to avoid in arithmetic, spelling, geography, grammar, history, civics; also Examination procedure and Requirements for civil service jobs.

Send \$1.00 to Teck Book Co., 461 8th Ave, New York

INDEX TO ADVERTISERS

Aerovox Corporation.....	318
Akrad Products Company.....	318
Aladdin Radio Industries, Inc.....	316
Allied Radio Corp.....	307
American Transformer Co.....	311
Arrow Sales Company.....	314
Bud Radio, Inc.....	297
Brush Development Co., The.....	309
Burstein-Appelbee Co.....	320
Cameradio Company.....	318
Candler System Co., The.....	308
Capitol Radio Engineering Institute.....	310
Central Radio Laboratories.....	296
Chicago Wheel & Mfg. Co.....	299
Classified Ads.....	320
Cornell-Dubilier Corp.....	314
Coyne Electrical School.....	315
Dodges Institute.....	304
Goldentone Radio Company.....	296
Gordon Specialties Company.....	312
Hallcrafters, Inc.....	Back Cover
Hammarlund Mfg. Co.....	317
Hygrade-Sylvania Corp.....	302
Hetro Electrical Industries, Inc.....	311
Instructograph Company.....	319
International Correspondence Schools.....	320
International Resistance Company.....	261, 316
Jensen Radio Mfg. Co.....	313
Kato Engineering Company.....	314
Kenyon Transformer Co., Inc.....	305
Lincoln Engineering School.....	318
McElroy, T. R.....	308
Mallory & Co., Inc. P.R.....	262
Mcissner Mfg. Co.....	301
Metal Cast Products Co.....	295
Midland Television, Inc.....	297
Midwest Radio Corp.....	Inside Back Cover
Million Radio & Television Lab.....	314
Modell's.....	295
Montgomery Ward.....	305
National Radio Institute.....	257
National Schools.....	299
National Union Radio Corp.....	299
New York Y. M. C. A. Schools.....	312
RCA Industries, Inc.....	295
RCA Manufacturing Co.....	293
Radio City Products Co.....	312
Radio Service Institute.....	303
Radio & Technical Publishing Co.,	309, 296, 294
Radio Training Ass'n of America.....	306
Radolek Company, The.....	319
Raytheon Production Corp.....	292
Readrite Meter Works.....	311
Rider, John F.....	305
Rotospeed Co., The.....	320
Scott Radio Labs., Inc. E. H.....	308
Sevan Company.....	308
Silver Corp., McMurdo.....	303
Solar Mfg. Corp.....	319
Sprayberry Academy of Radio.....	319
Standard Transformer Corp.....	304
Supreme Instruments Corp.....	295
Teleplex Company.....	297
Triad Mfg. Co., Inc.....	294
Trimm Radio Mfg. Co.....	301
Triplett Electrical Instrument Co.....	Inside Front Cover
Tri-State College.....	309
Try-Mo Radio Co., Inc.....	304
Utah Radio Products Company.....	310
Webster Company, The.....	298
Weston Electrical Instruments Corp.....	300
Wholesale Radio Service Company.....	291, 320
Wincharger Corporation.....	303
Wright-DeCoster Co., Inc.....	306
Zephyr Radio Company.....	319

CODE—TAPES FOR EVERY NEED



For Example: Airways Tapes
You can easily learn or improve your Radio or Morse Code—typical messages are sent you by the INSTRUCTOGRAPH, at any speed. Senior model with 10 tapes and Book of Instructions—\$20.25 (Rented at low cost.) Junior model with 5 tapes and Book of Instructions—\$12.00 (Not rented). Complete oscillator equipment, less battery, \$6.50. Send for full information today to—

INSTRUCTOGRAPH CO., Dept. NR-11, 912 Lakeside Pl., Chicago, Ill. Representatives for Canada: Radio College of Canada, 863 Bay St., Toronto.

Buy on Cash or Terms—HALLICRAFTER and R.M.E. SHORT WAVE RECEIVERS—SPEED-X and VIBROPLEXES, TELEGRAPH INSTRUMENTS AND HAND BOOKS.

QUALITY recommends

Condensers by

WET... DRY
PAPER
MICA... TRIMMER



Please Write for Details

SOLAR MFG. CORP. 599-601 Broadway New York City

HERE'S YOUR RADIO!

Famous ZEPHYR RADIOS 50% off

All NEW models, latest features, AC—DC. All Electric, Battery or Auto Radios with Money Back GUARANTEE. Write for FREE catalog showing complete line. Ask about our Agent-User plan.

ZEPHYR RADIO COMPANY
13137 Hamilton Ave., Detroit, Michigan

Just Out!

1938

Radio Data Book

The editors of RADIO NEWS are pleased to announce the publication of a new radio data book—one that will prove extremely helpful to every radio man. The contents of this book include:

TELEVISION: Present Status; Building a "Don Lee" Television Receiver.

RADIO RECEIVERS: 1-Tube Pocket Set; 4-Tube S. W. Set; Low-Cost High-Fidelity Receiver; 5-550 Meter R-S-R Set.

RECEIVING TUBE CHARTS

SERVICE & LABORATORY APPARATUS: Test Oscillator; "Capatron" Signal Generator; Multi-Range Tube Voltmeter; Midget Cathode-Ray Oscilloscope.

PUBLIC ADDRESS SYSTEMS: 3-Channel Pre-Amplifier; 10-Watt Amplifier; Direct Coupled Amplifier; Decibel Ratings.

SERVICE HINTS: Mobile P. A. System; Vibrator Trouble Shooting; Curbing Noise In Supers; Service Charges.

EXPERIMENTAL RADIO DATA

AMATEUR AIDS: Learning Code; BCL Troubles; Transmitting Tube Charts.

AMATEUR RECEIVERS AND TRANSMITTERS: "Quartet" Receiver; 10-Meter Converter; Crystal-Control 5-10-20 Meter Transmitter; M.O.P.A. Transmitter.

WORLD SHORT-WAVE STATION LIST

Given Free!

You can get a copy of the 1938 Radio Data Book absolutely free by subscribing now for 5 issues of RADIO NEWS at \$1. (Canada & Foreign \$1.25). Send remittance to:

RADIO NEWS, Dept. 3711,
461 8th Ave. New York, N. Y.

The Technical Review

(Continued from page 299)

FREE BULLETINS

180-Page Radio Catalog

An announcement has just been received of the new Wholesale Radio Service Catalog No. 69. Readers will find separate sections devoted to home, farm, and auto radios, public-address and "Ham" equipment, replacement parts, test equipment and a line of electrical appliances. Copies can be ordered free from RADIO NEWS, 461 Eighth Avenue, New York City.



Latest Radio Catalog

A new and larger 1938 catalog on nationally known radio receivers has just been announced by Modell's. Servicemen and radio salesmen can obtain a free copy of this book by writing to RADIO NEWS, 461 Eighth Avenue, New York City.

Free Parts Catalog

RADIO NEWS offers through the courtesy of Bud Radio Inc., the latest Bud catalog No. 138 listing an unusually large assortment of radio parts, including transmitting and receiving condensers, coil-kits, metal cabinets, panels, and racks, microphone stands and a multitude of radio-hardware accessories. This 36 page book is free to "hams", servicemen, and experimenters. Write to RADIO NEWS, 461 Eighth Avenue, New York City.



Just Released—1938 Catalog

The Allied Radio Corp. has just brought out their new 1938 catalog comprising more than 164 pages listing the new line of Knight radio receivers, transmitters, kits, P.A. systems, and other products. It has been compiled for convenient and quick reference. A free copy can be had by writing to RADIO NEWS, 461 Eighth Avenue, New York City.

RADIO NEWS Booklet Offers Repeated

FOR the benefit of our readers, we are repeating a list of valuable, FREE technical booklets and manufacturers' catalog offers, which were described in detail in the May, June, July, August, September and October, 1937, issues. The majority of these booklets are still available to all readers. Simply ask for them by their code designations and send your request to RADIO NEWS, 461 Eighth Avenue, New York, N. Y. The literature marked with an asterisk is available only to bona fide servicemen, dealers, and engineers. In applying for these folders it is necessary to send in your request on your card or letterhead. If you are an amateur give call

IT'S **BONUS** TIME
IN **RADIO**

Are You Getting YOURS?



THIS year—Radio's banner year—ought to pay you a handsome BONUS—\$25, \$50, \$100 EXTRA every month. But IS it? Hundreds of Sprayberry trained men are making that much extra out of increased salaries, increased profits from their own businesses from spare-time earnings. So can you.

\$175 A MONTH

BIG OUTFIT SENT

The Sprayberry course is complete. ADVANCED. Includes latest circuits and special series of spare-time BUSINESS BUILDERS. Also big PROFESSIONAL OUTFIT OF REAL RADIO TOOLS, TRIPLETT TESTER, 7-RIDER MANUALS, EBY ELECTRIC EYE, ETC.

Meet my student Joseph Arizabalo who says: "Now I'm in charge of the repair department of a big distributor—a permanent job. Thanks to your course, which was interesting and easy to understand, I'm making \$175 a month."

EASY TO START

My terms, as low as \$3 a month, make it easy to start, easy to keep on, easy to collect big dividends as you go. New FREE BOOK, "More Money in Radio" fully explains. Get your copy. Write me, or use the handy coupon.

SPECIAL COURSE FOR SERVICEMEN

Servicemen!—ask about my Special Course for YOU. Also fully explained in my big book, "More Money in Radio". Send for a copy—get complete facts.

MAIL NOW FOR FREE BOOK

F. L. SPRAYBERRY, Pres.,
SPRAYBERRY ACADEMY OF RADIO,
25-M, University Place, N. W.,
Washington, D. C.

Send me a FREE copy of "More Money in Radio," and facts about your new type of training.

Name..... Age.....

Address

City..... State.....

If interested in Service Course ONLY, Check Here
Paste Coupon on Penny Postcard and Mail.



LOWEST PRICES
New 1938 Radolek Radio Profit Guide contains complete showings of Radio Repair Parts, Radio Receivers, Public Address Amplifiers, Speakers, Microphones, Service Test Instruments, Technical Books, Radio Tools, Standard Brands! Everything you need in the Radio Business all at Lowest Prices. You save money at Radolek!

GUARANTEED QUALITY
Every item you get from Radolek is guaranteed. It must be right or we make it right. Standard merchandise produced by leading Manufacturers with Radolek's guarantee added!

FASTEST SERVICE
Everything in Radio promptly when you want it—and exactly what you want. Radolek's efficient organization insures you the fastest service in the Radio business. 25,000 Servicemen customers depend on Radolek service and benefit by Radolek's LOWEST PRICES. Send Now for the Radolek Radio Profit Guide. It will help you make money.

RADOLEK

601 W. Randolph, Chicago, Dept B-11

Send me the 1938 Radolek Radio Profit Guide FREE.

Name

Address

Serviceman Dealer Experimenter

**NEVER BEFORE!
AT THIS PRICE!**

TOBE CONDENSER ANALYZER



\$8.75 LESS 01A TUBE

AN AMAZING BARGAIN RUSH YOUR ORDER AT ONCE!

REG. PRICE \$11.40

TESTS paper, electrolytic, mica and oil-filled capacitors. Checks capacity, leakage resistance, leakage current, shorts, opens, etc. Built-in power supply for 110V., 50/60 cycle A.C. Employs neon indicator tube and an 01A. With leads, instructions and neon tube.

TOBE LINE FILTER



\$2.10 TYPE RF2 LIST PRICE \$4.95

RUSH YOUR ORDER NOW!

Reduces noises entering set through power line. Effective for all-wave receivers. Has special all-wave inductors. With cord, plug, metal case. No. WA12608.

WHOLESALE RADIO SERVICE CO.
NEW YORK, N.Y. CHICAGO, ILL. ATLANTA, GA.
100 SIXTH AVENUE 901 W. JACKSON BLVD. 430 W. PEACHTREE ST., N.W.
BOSTON, MASS. BRONX, N.Y. NEWARK, N.J. JAMAICA, L.I.

RADIO

holds great rewards for trained men



The big opportunities in Radio will be enjoyed by trained men. The International Correspondence Schools Radio Course, prepared by leading authorities and constantly revised, will help make you a trained man! A fascinating book—FREE.

AVIATION ENGINEERS are leaders in modern progress



Aviation depends upon engines, and knowledge of aviation engines is a long step toward success in this rapidly growing industry. Many leading aviation engineers today took their first step by mailing a coupon to the I. C. S. at Scranton. Why don't you follow their example?

INTERNATIONAL CORRESPONDENCE SCHOOLS

Box 8283-S, Scranton, Penna.

Explain fully about your course in the subject marked X:

- | | |
|---|---|
| <input type="checkbox"/> RADIO | <input type="checkbox"/> AVIATION |
| <input type="checkbox"/> Chemistry | <input type="checkbox"/> Accounting |
| <input type="checkbox"/> Invention | <input type="checkbox"/> Advertising |
| <input type="checkbox"/> Refrigeration | <input type="checkbox"/> Electrical Engineering |
| <input type="checkbox"/> Air Conditioning | <input type="checkbox"/> Drafting |
| <input type="checkbox"/> Architecture | <input type="checkbox"/> Show Card Lettering |
| <input type="checkbox"/> Good English | |

Name.....Age.....

Address.....

RADIO IN ITS ENTIRETY!

"B.A." serves the trade with every need in radio—complete 160-page catalog of nationally known radio receivers, public address, parts, supplies and equipment. Orders shipped same day received.

COMPLETE CATALOG AVAILABLE
BURSTEIN-APPLEBEE CO. 1012-14 McGEE ST. KANSAS CITY, MO.

- letters. The list follows:
- MY1—Service booklet. Readrite Meter Works.
 - MY6—Volume control guide. Central Radio Laboratory.
 - Je1—Circulars on power equipment. Pioneer Gen. E. Motor Corp.
 - Je4—Catalog on P. A. equipment. United Sound Engineering Co.*
 - Je5—Tube Chart Arcturus Radio Tube Co.*
 - Jy1—Instrument Topics. A new folder published periodically by Clough-Brengle Co.*
 - Jy2—Instrument Catalog. Triplett Electrical Instrument Co.
 - Jy4—Sound Equipment Guide. Wholesale Radio Service Co.
 - Jy5—Parts Catalog. Radolek Co.*
 - Jy6—Latest Catalog on accessories. Radio Corp. of America.*
 - At1—Broadside on Super-Pro. Hammarlund Mfg. Co.
 - At2—Catalog on Transmitting Equipment. Wholesale Radio Service Co., Inc.*
 - At3—Folder on Western Electric 633, a dynamic microphone.
 - At4—Tube Folder. Weston Electrical Instrument Corp.*
 - At5—P. A. Catalog. Webster Co.
 - At6—Catalog on Electrical Wiring Accessories. Harvey Hubbell Co.*
 - S1—Accessory Folder. American Phenolic Corp.
 - S2—Transformer Catalog. Kenyon Transformer Co.
 - S3—P.A. Equipment and Parts Catalog. Inter-World Trade Corp.
 - O1—Vibration Study with Neobeam Oscilloscope. The Sundt Engineering Co.*
 - O2—Sound Equipment Catalog. The Radolek Co.
 - O3—Instructive data for eliminating interference. The Sprague Products Company.*
 - O4—Catalog on "Nokoil" Speakers. Wright-DeCoster, Inc.
 - O5—Circular describing gas-engine a.c. electric plants. Kato Engineering Co.
 - O6—Replacement Condenser Catalog. Solar Mfg. Co.
 - O7—Guide Book on Peri-Dynamic Speakers. Jensen Radio Mfg. Co.

What's New in Radio

(Continued from page 318)

from 0.2 to 1400 volts, a.c. or d.c. in four ranges, the ohmmeter circuit measures resistance from 0.1 to 20 megohms and three current ranges are provided. This modern instrument comes complete with all accessories and operating data.

Low-Cost Velocity "Mike"

A few of the outstanding design and constructional features in the new Electro-Voice velocity microphone, Model V-1,



include: zero cavity resonance, hum-free design, high sensitivity, rated response of 40 to 10,000 cycles with a rising curve from 40 to 500 cycles and flat to cutoff, of output of minus 68 db., compact size, shock-proof mounting and built for tropical service.

Amateur Observer

(Continued from page 301)

- W6MOT-3, W6NLS-5, W6KNI-4, W6IBJ-5, W6MVK-5, W6KMF-3, W6MIP-8, W6KNG-7, W6JLU-8, W6LOB-7, W6ETZ-6, W7CMP-5, W7CUX-2, O4AK-1, VP5BZ-5, K4ETO-7, K6MBZ-4, H15R-3, H17G-8.
- 20 meters: G2BY-6, G2PG-5, G2NM-4, G5ML-7, G5SA-3, G5JS-5, G5JH-4, G5NI-4, G5TZ-5, G5JO-6, G5LU-3, G6TZ-5, G6BW-6, G6DL-7, G6LS-4, G6GO-5, G8IK-6, G5LV-6, G5NW-6, G6GR-5, F3NF-5, F5PU-4.

NEW BUSINESS HELP FOR SERVICEMEN!

Do your own advertising and printing. Boost business 10% to 50% for a few cents weekly!

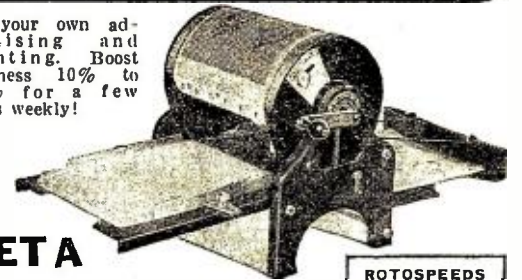

GET A ROTOSPEED DUPLICATING PRINTER

ROTOSPEEDS \$27.50
complete with all supplies

With a Rotospeed you can cut costs and increase business at the same time. Do your own printing—invoices, letterheads, statements, receipts, etc. Do your own advertising—cards, letters, handbills, offering specials, guarantee certificates, etc. Reproduce ANYTHING—writing, typing, drawing—do it quickly, simply, easily and at amazing savings.

FREE TRIAL OFFER Write for details regarding it. Also how other servicemen are building business with a Rotospeed.
The ROTOSPEED CO. 357 S. Wilkinson St. Dayton, Ohio

A SMALL BUSINESS of YOUR OWN

WITH LITTLE OR NO CAPITAL INVESTMENT

by **WILLIAM ALLAN BROOKS**

This helpful book contains 1000 tried and proven ways for the individual having little or no capital to build a modest, dependable business. It is intended primarily for the thousands of men and women who do not want to trust their economic security to the whims of an employer—also for the woman who wants to add to the family income, for the middle-aged man or woman dependent upon others, for the recent college graduate who has not yet found himself. The 1000 plans are true reports of the various ways in which thousands of persons are right now earning money by their own initiative.
\$1.00
Send \$1 to Teck Book Co., 461 8th Ave, New York

Read Classified Advertising—It Pays

Advertisements in this section sixteen cents a word for each insertion. Name and address must be included at the above rate. Cash should accompany all classified advertisements unless placed by an accredited advertising agency. No advertisements for less than 10 words accepted. Objectionable or misleading advertisements not accepted. Advertisements for these columns should reach us not later than 3rd of 2d month preceding issue.
TECK PUBLICATIONS, INC.
461 Eighth Ave. New York, N. Y.

Correspondence Courses

USED Correspondence Courses and Educational Books sold or rented. Inexpensive. Money-back guarantee. Write for Free Catalog listing 4000 bargains. (Courses Bought.) Lee Mountain, Plsgh, Alabama.

BIG BARGAIN Catalogue Courses 10c. Handling 799 Broadway, New York.

Patent Attorneys

PATENTS. Instruction "How to Establish Your Rights" and form, "Evidence of Conception" sent Free! Lancaster, Allwine & Roumel, 414 Bowen Building, Washington, D. C.

PATENTS—Advice and booklet free. Highest references. Best results. Promptness assured. Watson E. Coleman, Patent Lawyer, 724 9th Street, Washington, D. C.

Patents and Inventions Wanted

INVENTIONS COMMERCIALIZED. Patented or unpatented. Write Adam Fisher Company, 278 Enright, St. Louis, Missouri.

Radio

RADIO WRITING EXPLAINED—Continuity sample page. Dime, and stamp. (Copyright 1937). G. N. Atworth, 2019-A Highland Ave., Knoxville, Tenn.

RADIO MEASURING INSTRUMENTS repaired, calibrated, built. Component parts tested—Reasonable. Peldyne Company, Engineering Building, Chicago, Illinois.

Radio Instruction

COMPLETE TRAINING for all Amateur and Professional Radio Licenses. New York Wireless School, 1123 Broadway, New York.

JUST TOUCH BUTTON...

LATEST 18-TUBE MIDWEST TUNES ITSELF BY ELECTRIC MOTOR!

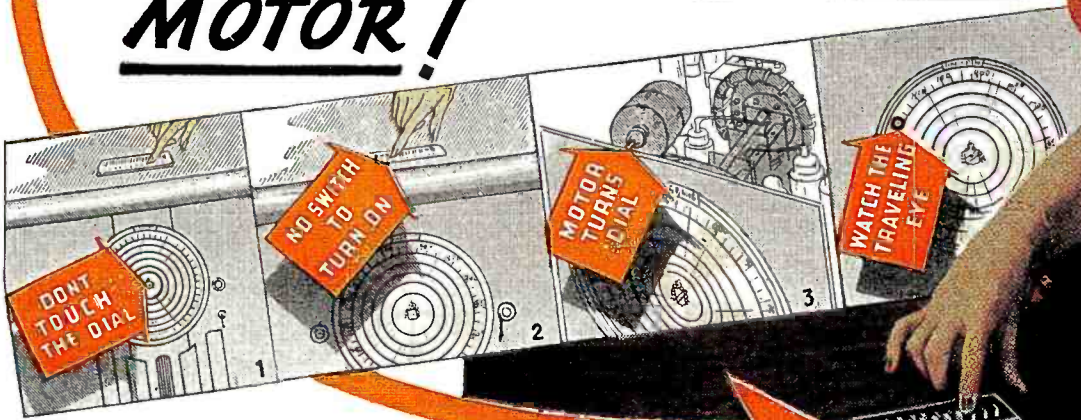

FACTORY-TO-YOU

Only **\$39⁹⁵** LESS TUBES

NEW LOW BASE PRICE CHASSIS

TODAY'S biggest radio news is **MOTORIZED Tuning**...an exclusive Midwest development! Just touch a button...and **FLASH**...its corresponding station comes in perfectly tuned. No more dial twiddling, no more neck twisting, no more goggling. Just touch a button—the foreign or domestic station it corresponds with floats right in...like magic...at the exact center of resonance.

Zip...Zip...Zip...you can bring in 9 perfectly tuned stations in 3 seconds! All this happens in $\frac{1}{3}$ second with Midwest Perfected Motorized Tuning: (See above illustrations) (1-2) You touch button; (3) Electric motor speeds dial towards corresponding station; (4) Colorful Bull's Eye darts across dial and locates itself behind station; (5) Dial stops itself at the station's exact center of resonance and eye "winks" as program comes in perfectly tuned.

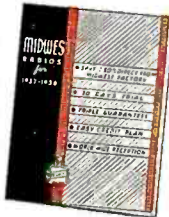

[SERVICE MEN: Join nation-wide Midwest service organization. Write for free details.]

SEND FOR **FREE 1938 CATALOG**

The famous Midwest factory-to-you plan, proven by 18 years of success, is just as exciting. It enables you to buy at wholesale prices—to save up to 50%—to make your radio dollar go twice as far—to enjoy 30 days **FREE** trial in your home.

Enjoy World's Most Advanced Radio for 30 Days In Your Home. Don't Risk A Penny!

Act at once on this unusual factory-to-you offer. We send any Midwest radio you desire to your home. You use it 30 days, and compare it with other radios you have owned or heard. You are triply protected with Foreign Reception Guarantee, One-Year Warranty and Money-Back Guarantee. **BRILLIANT FOREIGN RECEPTION**

Super power and 101 advanced features enable you to bring in weak distant foreign stations like "locals." The six bands of this magnificent 18-tube set give you brilliant world-wide reception...over a range of 12,000 miles and more. You'll be thrilled with its marvelous 6-continent overseas reception. Secures American, Canadian, Police, Amateur, Airplane, Ship broadcasts... and finest Foreign programs.

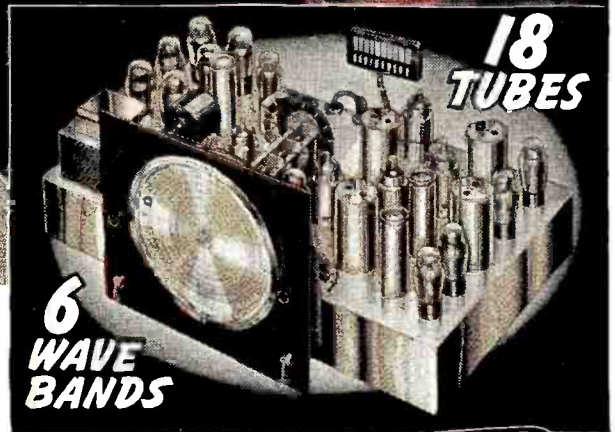

30 DAYS FREE TRIAL

TERMS AS LOW AS 50¢ A WEEK

You don't risk a penny when you try this more exciting, more powerful **MOTORIZED** radio in your home for 30 days. So mail the coupon **NOW!**

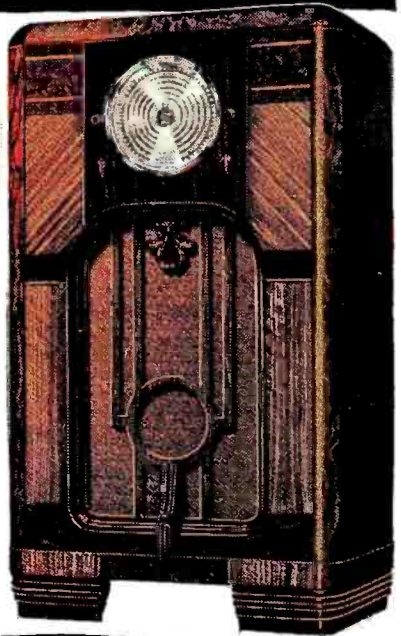

PASTE COUPON ON 1¢ POSTCARD... OR

Write Today!

MIDWEST RADIO CORPORATION
Dept. FF-11 Cincinnati, O.
Send me your new **FREE** catalog and complete details of your liberal 30-day **FREE** trial offer. (Special offer and prices prevail only when dealing direct with factory by mail.)

Name.....
Address.....
Town..... State.....
User-Agents Make Easy Extra Money. Check Here for details
 Check Here for 1938 BATTERY catalog

MIDWEST

WORLD-WIDE RADIOS

MIDWEST RADIO CORPORATION
DEPT. **FF-11** CINCINNATI, OHIO, U.S.A.

the hallicrafters

AMERICA'S MOST COMPLETE LINE OF COMMUNICATIONS RECEIVERS!

SUPER SKYRIDER

ULTRA SKYRIDER

SKY CHALLENGER

SKYRIDER COMMERCIAL

SKY CHIEF

SKY BUDDY

There's a precision-engineered Hallicrafters Receiver for every amateur or short wave listener, whether he's just a beginner on the air or an "Old Timer" who is playing with 5 meters, and whatever the state of his purse!

All Hallicrafters Receivers available on liberal time payments through your dealer.

Write for illustrated booklet fully describing the Hallicrafters Line.

Hallicrafters Receivers are licensed by RCA and Hazeltine.

AMERICA'S LEADING MANUFACTURER OF COMMUNICATIONS RECEIVERS

the hallicrafters inc.

2603 INDIANA AVENUE, CHICAGO, U. S. A. • CABLE ADDRESS "Hallicraft" CHICAGO